

BOSS FYREBOX™ TECHNICAL GUIDE

Contents

Publication Version 2

Introduction 3

BOSS FyreBox™ 3

Key Benefits 3

Important Information..... 4

Contact Details..... 4

Applications..... 5

Traditional Passive Firestopping vs BOSS FyreBox™ 5

Acoustic Performance of the BOSS FyreBox™ System..... 6

 Table 1. – Acoustic Performance 6

How does it work in a fire? 6

Fire Performance of the BOSS FyreBox™ System 7

 Wall, Concrete Slab & Ceiling /Floor Element Requirements..... 8

 Approved Elements - Wall Systems 8

 Approved Elements - Concrete Floor Slabs..... 8

 Approved Elements - Ceiling / Floor systems 8

 Thermal Wrap known as the P40-MAK Wrap..... 9

 Mastic Seal 9

Services That Can Pass Through the BOSS FyreBox™ 9

 Table 2. Wall Systems with a 60min Fire Rating 10

 Table 3. Wall Systems with a 90min Fire Rating 11

 Table 4. Wall Systems with a 120min Fire Rating 12

 Table 5. Concrete Slab & Floor / Ceiling Systems with a 60min Fire Rating 13

 Table 6. Concrete Slab & Floor / Ceiling Systems with a 90min Fire Rating 14

 Table 7. Concrete Slab & Floor / Ceiling Systems with a 120min Fire Rating 15

BOSS FyreBox™ Size Selection 16

Minimum Fill Rates 16

Services Spacing Requirements 16

Project Shop Drawing..... 17

 Trapeze..... 17

Awards 17

Installation – Head of Wall / Soffit Mount – Framed Walls..... 18

Construction Details – Head of Wall / Soffit Mount – Framed Walls 22

Construction Details – BOSS Batt – Head of Wall / Soffit Mount Infill Panel in Framed Wall Systems – 60, 90 & 120min Requirements..... 24

Installation – Mid Wall Mount – Framed Walls 25

Construction Details – Mid Wall Mount – Framed Walls 28

Construction Details – BOSS Batt – Mid Wall Infill Panel in Framed Wall Systems – 60, 90 & 120min Requirements.. 29

Installation – Other Walls – Rigid Walls / Modular Wall Systems 30

Construction Details – Other Walls – Rigid Walls / Modular Wall Systems..... 34

Construction Details – BOSS Batt – Head of Wall / Soffit Mount Infill Panel in Rigid Walls / Modular Wall Systems - 60min Requirements..... 36

Construction Details – BOSS Batt – Head of Wall / Soffit Mount Infill Panel in Rigid Walls / Modular Wall Systems – 90min & 120min Requirements..... 37

Construction Details – BOSS Batt – Mid Wall Infill Panel in Rigid Walls / Modular Wall Systems – 60min Requirements 38

Construction Details – BOSS Batt – Mid Wall Infill Panel in Rigid Walls / Modular Wall Systems – 90min & 120min Requirements..... 39

Installation – Concrete Floor Slabs – Retro Fit..... 40

Construction Details – Concrete Floor Slabs – Retro Fit 43

Installation – Fire Rated Ceiling / Floor Systems..... 44

Construction Details – Fire Rated Ceiling / Floor Systems..... 47

Glossary of Terms..... 48

Health and Safety..... 49

Limitation 49

Further Information 49

Thankyou

Thankyou for purchasing or enquiring about the BOSS FyreBox™. We manufacture our products to the highest quality standards, and we appreciate your supporting an Australian manufactured product from an Australian Owned company. If you have any feedback or questions relating to the product or it’s designed purposes, please contact us on 1300 502 677 or +61 2 9531 8591 or info@bossfire.com.au.

Publication Version

This document may be superseded by newer versions. If you are unsure of whether or not this document is a current publication, please call us on 1300 502 677 or +61 2 9531 8591 or info@bossfire.com.au to confirm.

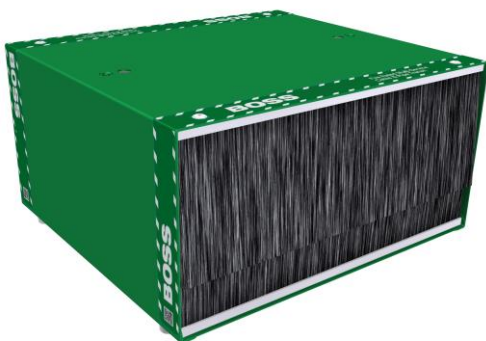

Introduction

The **BOSS FyreBox™** is a cable and pipe transit device used for firestopping multiple services through fire rated barriers to achieve various Fire Resistance Levels (FRLs). It can be installed into a variety of fire rated walls, concrete floor slabs and plasterboard ceiling / floor systems. It is tested and assessed in accordance with AS1530.4:2014 and AS4072.1-2005. Performance FRLs and substrate information can be found in in Tables 2-7 on pages 10-15 of this guide. This Technical Guide outlines the how the BOSS FyreBox™ works, it's performance ratings and methods required to fit the BOSS FyreBox™ to the relevant substrate, in either fire rated walls, concrete floor slabs and fire rated ceiling / floor systems.

BOSS FyreBox™

The BOSS FyreBox™ is revolutionising firestopping methods for large bundles of mixed services. Designed to allow large bundles of pipes and cables to all pass through one single fire rated enclosure, the BOSS FyreBox™ is the only tested and proven method of firestopping multiple services with such simplicity of installation and ease of compliance. It is commonly used for apartment entry configurations above entry doors to apartments and sole occupancy units. The BOSS FyreBox™ is also suited for service risers, shafts, plant areas and data rooms in a variety of residential, commercial, and industrial buildings.

For individual services or infill-only requirements, BOSS Fire® also offers a wide range of traditional firestopping methods that includes collars, sealants and other cavity barriers such as batts, pillows and mortar.

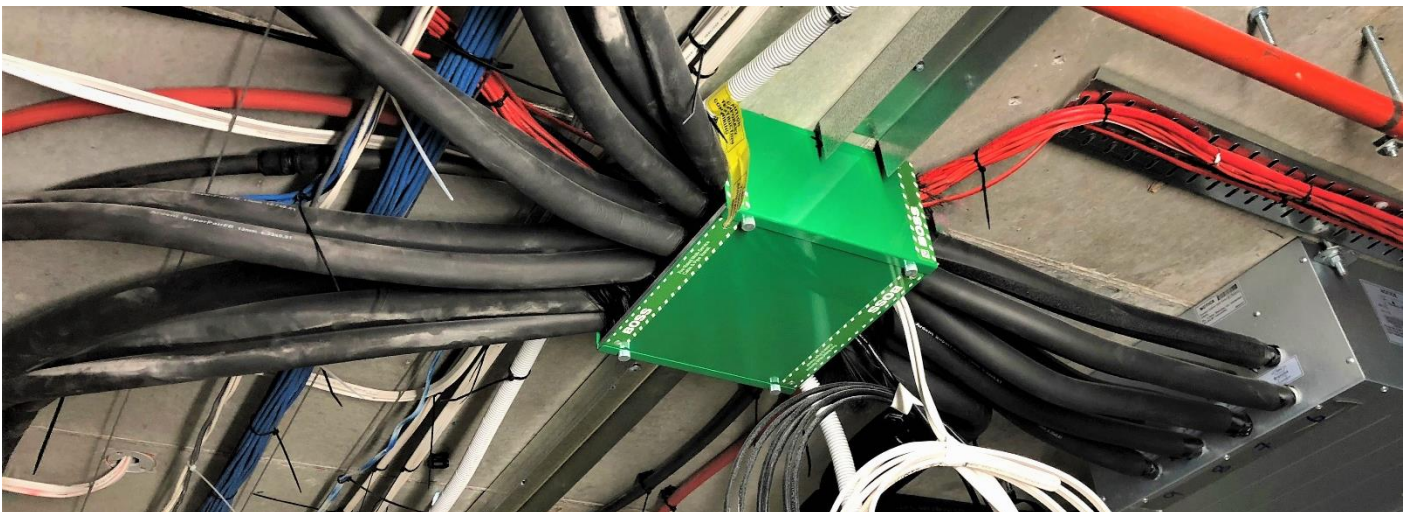

Key Benefits

The BOSS FyreBox™ offers many benefits, summary of these include:

- **30min, 60min, 90min and 120min Fire Ratings**
- **Up to Rw50 acoustic performance**
- **Approved for walls, concrete slabs & ceiling / floor systems.**
- **Wide variety of services and mixed combinations**
- **Saves up to 90% of labour costs**
- Makes AS1851 periodic maintenance inspections simple and reliable
- Services can be easily added after installation
- Tested & approved to AS1530.4:2014 and AS4072.1-2005
- Many typical apartment service configurations available
- Large variety of electrical, plumbing & HVAC services certified
- Drastically lowers total cost of apartment firestopping



Important Information

Fire separation is a critical part of life safety in building design and must be treated carefully. Follow the steps below to help ensure your installation is carried out correctly and compliantly.

1. Select the BOSS FyreBox™ for installation into configurations pursuant to Branz FC12925 Issue 7 (Approved Applications) or “as tested” applications, which include fire rated walls, concrete slabs & ceiling / floors.
2. Penetrations in fire rated barriers can weaken the fire integrity of a building element. Therefore, you must always minimise the size of apertures, and select the smallest size BOSS FyreBox™ available that your installation and configuration requires.
3. Always read and understand the appropriate certification, Branz FC12925 Issue 7, supplied with this Technical Guide and how it relates to your specific application. If you did not receive a copy of this report please contact BOSS Fire® to request a copy. If you do not understand it, then please contact BOSS Fire® for technical clarification on the details below.
4. Ensure the Approved Applications detailed in Branz FC12925 Issue 7 is applicable to your construction details or for further details on ‘as-tested’ systems contact BOSS Fire® on the details below.
5. The BOSS FyreBox™ must be installed in accordance with the manufacturer’s specifications & certification or be subject of a Performance Solution. Performance Solution – (defined by the National Construction Code 2019 – Volume 1 Amendment 1) means a method of complying with the Performance Requirements other than by a Deemed-to-Satisfy Solution. Refer to section Part A2.2 of NCC Volume 1 Amendment 1 for more information.
6. This Technical Guide must be read in conjunction with the product test or assessment reports. Always read and understand these documents carefully.
7. Always check your relevant Building Regulations, local laws and AS/NZS Standards to properly understand your obligations.
8. Ensure you have an accredited Certifier or 3rd party compliance inspector to check your proposed system before installation. Pre-approval can help to save significant costs and delays and avoid non-compliance.
9. The user must not modify the BOSS FyreBox™ in anyway other than methods outlined in this guide by the manufacturer.
10. NOTE: This guide will be updated from time to time, and you must ensure they are reviewing the most recent version at the time of installation. Please visit the BOSS Fire® website (bossfire.com.au) to check for further updates or contact us on the below details.
11. If you don’t understand anything contained in this guide and would like clarification, contact BOSS Fire® on the details below.

Contact Details

- **Phone Toll Free (AUS):** 1300 502 677
- **International:** +612 9531 8591
- **Email:** info@bossfire.com.au
- **Website:** bossfire.com.au

Applications

The BOSS FyreBox™ is suitable for a wide variety of buildings where multiple services need to pass through a fire rated wall, concrete floor slab or ceiling/ floor system. Typical projects include apartments, aged care, hotels & student accommodation for Sole Occupancy Unit entries, services cupboards or shafts and risers in high rise buildings. The BOSS FyreBox™ can also be used in industrial & commercial buildings such as factories, data centres, hospitals, and retail facilities. Typical bundles of services include:

- Steel Sprinkler Pipes
- Copper Gas / Water Pipes
- uPVC & cPVC Pipes
- PEX & PEX-AL Water & Gas Pipes
- Air Conditioning Lagged Copper Pipes / Paircoil
- Lagged & Unlagged PE-RT or PE-RT Kelox Pipes
- Power Cables
- Mains Cables
- uPVC Conduits
- Data / Comms Cables – NBN, CAT6, CAT5E, CAT7
- Coax Cables – CATV / MATV / SMATV
- Security, LAN, Fig 8, Fibre Optic, EWIS & Speaker

For detailed approval information on the fire certification including service sizes, approved substrates and tested systems refer to Tables 2-7 on pages 10-15 of this guide.

Traditional Passive Firestopping vs BOSS FyreBox™

The BOSS FyreBox™ has a large variety of certified services tested and approved that simply “**pass through**” the product. **There is no need to core individual penetrations for each service, or cut any inserts, nor do you need to seal or treat every individual service with traditional sealants, collars or wraps.** The BOSS FyreBox™ allows you to group various electrical, plumbing, HVAC+R services all through one easy to use and easily certified product. The unique **BrushSeal™** allows services to be passed through the FyreBox™ at any time during construction or later after a project has been completed (the FyreBox™ must not be overfilled to a point where the metal chassis bends, flexes or bows from overfilling. The internal Intumescent Sachets & BrushSeals™ **must not** be removed or damaged). This makes it easier than ever before for maintenance contractors and building managers to maintain fire compliance once the building is occupied.



Above: Traditional Passive Fire

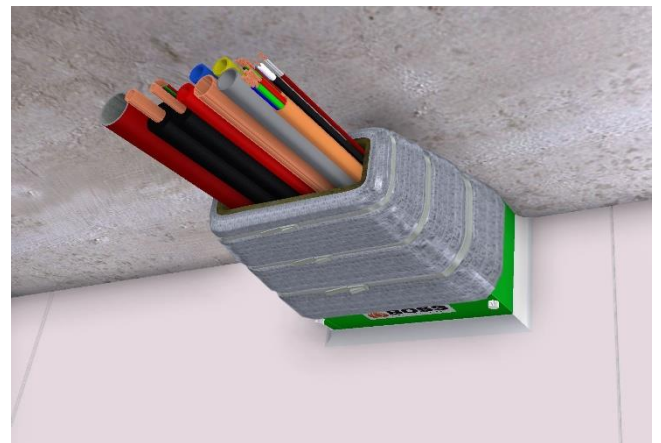

Above: BOSS FyreBox™

Acoustic Performance of the BOSS FyreBox™ System

Marshall Day Acoustics Pty Ltd have assessed the acoustic performance and sound transmission loss of the BOSS FyreBox™ in various typical scenarios. Refer Report Lt 001 R01 20181092.



Table 1. – Acoustic Performance

Location	System	Conditions	Sound Insulation
Above Apartment Entry Door	BOSS FyreBox™ completely open combined with 10mm plasterboard ceiling.	<ul style="list-style-type: none"> BOSS FyreBox™ located within 1.5m from entry door. 	≥ Rw 40
In Apartment Corridor Wall	BOSS FyreBox™ with BOSS P40-MAK Wrap on both sides with 10mm plasterboard ceiling.	<ul style="list-style-type: none"> BOSS FyreBox™ located anywhere within corridor wall above the ceiling. 	≥ Rw 50

How does it work in a fire?

The BOSS FyreBox™ consists of an advanced high pressure intumescent that, upon getting exposed to high temperatures, expands to create a high performance fire seal. Coupled with the unique BOSS Fire® BrushSeal™ that is designed to make the installation and compliance simple, and when built as a system ultimately leads to an industry-leading level of protection.

The BOSS FyreBox™ benefits from the same advanced intumescent technology as the best-in-category BOSS FireMastic-HPE™ intumescent sealant.

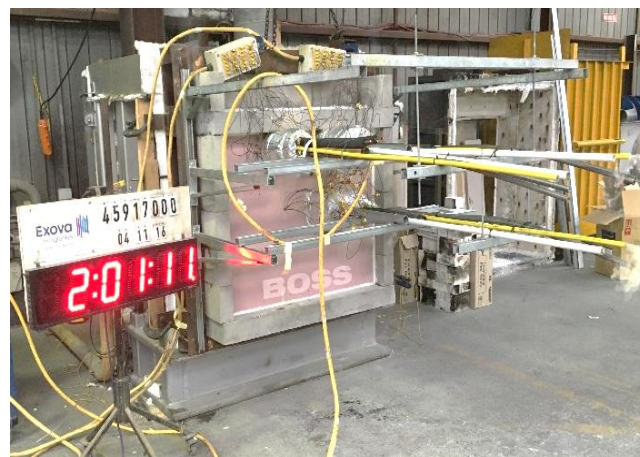

The BOSS FyreBox™ shown on the right during a fire test just after 120 minutes.



BOSS FyreBox™ 150mm and 300mm shown above after successfully passing a 120minute AS1530.4:2014 Fire Resistance test at **Warringtonfire, Dandenong VIC**. The images show the intumescent seals inside the BOSS FyreBox™ expand and completely seal around the services passing through the FyreBox™.

Fire Performance of the BOSS FyreBox™ System

The BOSS FyreBox™ works as a system in accompaniment to:

- The wall, concrete floor slab or ceiling / floor system.
- The mastic seal.
- The various types of services that pass through the FyreBox™.
- The P40-MAK Wrap; which may or may not be required (depending on FRL and services used) to increase the thermal insulation values of services on walls and is required on concrete slabs and ceiling / floors.

The FRL related to that system is determined by the least performing element contained in the system.

Example 1:

- **Wall:** Fire Rated Plasterboard wall 118mm thick with an established FRL of -/60/60.
- **Mastic Seal:** Installed in accordance with this Technical Guide.
- **Services:** Uninsulated 40mm copper pipes. Up to FRL -/120/120 with P40-MAK Wrap and up to FRL -/120/- without wrap. (As shown in Tables 2- 4 of this guide pursuant to Branz FC12925 Issue 7).
- **P40-MAK Wrap:** Used in the example case to wrap around services in accordance with this Technical Guide. Product used to increase insulation ratings up to 120 minutes.

Therefore, the above system is limited by the wall element and will be subject to an FRL -/60/60 as a system.

Example 2:

- **Wall:** Solid Masonry wall 140mm thick with an established FRL of -/120/120.
- **Mastic Seal:** Installed in accordance with this Technical Guide.
- **Services:** Paircoil up to 13/19mm insulated copper pipes. FRL -/120/120 with P40-MAK Wrap and FRL -/120/90 without wrap. (As shown in Table 3 of this guide pursuant to Branz FC12925 Issue 7).
- **P40-MAK Wrap:** Not used in the example case. Product used to increase insulation ratings up to 120 minutes.

Therefore, the above system is limited by the unwrapped services and will be subject to an FRL -/120/90 as a system.

Example 3:

- **Wall:** Fire Rated Plasterboard wall 124mm thick with an established FRL of -/90/90.
- **Mastic Seal:** Installed in accordance with this Technical Guide.
- **Services:** Typical apartment entry configuration consisting of the following mixed services as shown in Table 4 of this guide pursuant to Branz FC12925 Issue 7):
 - Multiple A/C Paircoil up to 13/19mm insulated copper pipes.
 - (Up to FRL -/120/120 with P40-MAK Wrap and up to FRL -/120/90 without wrap).
 - 20mm PEX Pipes for Hot, Cold & Recycled Water.
 - (Up to FRL -/120/120 with P40-MAK Wrap and up to FRL -/120/90 without wrap).
 - 25mm PEX AL Pipe for Gas.
 - (Up to FRL -/120/120 with P40-MAK Wrap and up to FRL -/120/90 without wrap).
 - 60.3mm Steel Sprinkler Pipe .
 - (Up to FRL -/120/120 with or without P40-MAK Wrap).
 - Sub Mains Power Cable 2C+E 16mm².
 - (Up to FRL -/120/120 with P40-MAK Wrap and up to FRL -/120/90 without wrap).
 - CAT 6, EWIS, Security, MATV, Intercom & COAX Communications Cables.
 - (Up to FRL -/120/120 with P40-MAK Wrap and up to FRL -/120/90 without wrap).
 - 25mm uPVC Conduit (NBN).
 - (Up to FRL -/120/120 with or without P40-MAK Wrap).
- **P40-MAK Wrap:** Not used in the example case. Product can be used to increase insulation ratings up to 120 minutes.

Therefore, the above system is limited by wall system and will be subject to an FRL -/90/90 as a system.

Wall, Concrete Slab & Ceiling /Floor Element Requirements

To achieve the desired FRL, the system must be constructed in accordance with Branz FC12925 Issue 7 or exactly as per an 'as-tested' system. You must read and understand Branz FC12925 Issue 7 or applicable Test Report supplied with this Technical Guide. If you did not receive a copy of this report, please contact BOSS Fire to request a copy. If you do not understand it, please contact BOSS Fire® on 1300 502 677 or info@bossfire.com.au for clarification. Note: The overall system is subject to the lowest performing element within the system.

All relevant wall, concrete slab & ceiling / floor elements pursuant to Branz FC12925 Issue 7, (Approved Elements) must also have the same or greater established FRL as the BOSS FyreBox™ via a test or assessment in accordance with AS1530.4: 2014 or AS4072.1-2005 to achieve the FRL's outlined in Tables 2-7 on pages 10-15.

Approved Elements - Wall Systems

All Approved Wall Elements must be minimum 100mm thick or use a locally built-up method in addition to the wall to meet this minimum thickness threshold as outlined further below. Approved wall elements include:

- Steel or Timber Framed Fire Rated Plasterboard Lined Walls
- Blank Infill Panel of BOSS Batt
- Concrete
- Solid or Hollow Masonry / Block walls
- AAC / Hebel
- Speedpanel
- Korok
- Supapanel
- Pronto Panel
- Dintel
- AFS
- Shaftliner / Shaftwall
- Partiwall / Party Wall
- IntRwall
- Barrierline
- INEX Wall Systems
- AlphaPanel Wall Systems

Where the wall is less than the 100mm minimum thickness, it must be locally increased around the BOSS FyreBox™ by adding approved thickening materials to maintain 100mm. These should surround the perimeter of the BOSS FyreBox™ by minimum 100mm.

Materials used to locally thicken the wall include:

- Fire Rated Plasterboard
- BOSS Batts

Approved Elements - Concrete Floor Slabs

Concrete floor slabs include:

- Concrete Floor Slabs Minimum 70mm Thick for 60min fire rating requirements.
- Concrete Floor Slabs Minimum 110mm Thick for 90min & 120min fire rating requirements.

Approved Elements - Ceiling / Floor systems

Ceiling / Floor Systems include:

- Ceiling / Floor systems comprised of fire rated plasterboard ceiling to the underside of timber framing with particle board flooring with an overall minimum thickness of 235mm.

Thermal Wrap known as the P40-MAK Wrap

The performance of the FRL outlined in Tables 2, 3 & 4 on pages 10, 11 & 12 offers two options, one where services are wrapped using the **BOSS P40-MAK Wrap**, and the other without a wrap for wall applications. Tables 5, 6 & 7 on pages 13, 14 & 15 refer to only wrapped configurations related to concrete slabs, and ceiling / floor applications. The **P40-MAK Wrap** is supplied in pre-cut lengths 300mm wide. For wall systems, the **P40-MAK Wrap**, must wrap around the bundled services on both sides of the wall and butt up to the brushes on the BOSS FyreBox™. For concrete slabs & ceiling / floor systems the wrap must wrap around the bundled services and the protruding BOSS FyreBox™ on the top side of the concrete slab or ceiling / floor system.

Mastic Seal

The system comprises of a seal of BOSS FireMastic-300™ to be applied between the BOSS FyreBox™ and the substrate. It is important that mastic seal is applied in accordance with this installation guide.

It is recommended to use **BOSS FireMastic-300™** for the mastic seal. Other approved sealants include:

- Knauf Bindex Fire Sealant
- CSR Fire Seal
- Hilti CP606
- HB Fuller Firesound
- Sika Flex-400 fire sealant

For more information, please contact BOSS Fire® on 1300 502 677 or info@bossfire.com.au.

Services That Can Pass Through the BOSS FyreBox™

Only services pursuant to Branz FC12925 Issue 7 (Approved Services) can pass through BOSS FyreBox™. Each different type and size of service is subject to a different performing Fire resistance Level (FRL). Tables 2-7 on pages 10-15 note the different performance relating to each service type in the BOSS FyreBox™ with and without the P40-MAK Wrap.

Extensive configurations containing various quantities and combinations of the Approved Services can pass through the FyreBox™ noting that the overall system Fire Resistance Level (FRL) will be governed by the least performing Approved Service that passes through the FyreBox™, or least performing Approved Element to which the FyreBox™ is installed. Refer to Tables 2-7 on pages 10-15. Note that minimum fill rates may apply to wall installations. For more information on minimum fill rates refer to page 16 “Minimum Fill Rates”.

Table 2. Wall Systems with a 60min Fire Rating

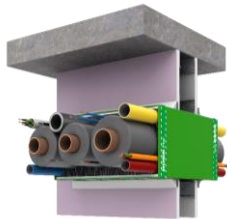
Product Description	Wall elements with an established FRL of 60/60/60 or -/60/60.	Service Penetration	FRL With P40-MAK Wrap	FRL Without P40-MAK Wrap *Minimum fill rates may apply.	Report Reference
It is considered that any combination of the below Approved Services, and any number of these Approved Services in the BOSS FyreBox™, will achieve an FRL in accordance with the least performing Approved Element or Approved Service from the below table provided that the FyreBox™ is not overfilled to a point where the metal chassis bends, flexes, or bows from overfilling. The internal Intumescent Sachets & BrushSeals™ must also not be removed or damaged.					
BOSS FyreBox™	Walls (Minimum 100mm Thick): <ul style="list-style-type: none"> Steel or Timber Framed Fire Rated Plasterboard Lined Walls Blank Infill Panel of BOSS Batt Concrete Solid or Hollow Masonry AAC & Hebel Speedpanel, Korok & Supapanel Pronto Panel Dincel AFS Shaftliner / Shaftwall Partiwall / Party Wall IntRwall Barrierline INEX Wall Systems AlphaPanel Wall Systems <p>Where wall is less than 100mm it may be increased by locally applied lining:</p> <ul style="list-style-type: none"> Fire Rated Plasterboard BOSS Batts <p>Refer item 5. Page 31 for more information.</p> 	Metal Pipes		Branz FC12925 Issue 7	
		Paircoil up to 13/19mm insulated copper Pipes	-/60/60		-/60/60
		Copper Pipe up to 25mm OD with minimum 13mm thick non-combustible lagging AS1530.1 or Armaflex FRV, K-Flex lagging or Thermobreak Lagging or similar elastomeric foam rubber such as nitrile, neoprene, or cross-linked polyolefin with density from 25kg/m ³ to 75kg/m ³ and complying with AS 1530.3, SFI=0 and SDI≤5.	-/60/60		-/60/60
		Copper Pipe up to 32mm OD with minimum 19mm thick Armaflex FRV, K-Flex lagging or Thermobreak Lagging or similar elastomeric foam rubber such as nitrile, neoprene, or cross-linked polyolefin with density from 25kg/m ³ to 75kg/m ³ and complying with AS 1530.3, SFI=0 and SDI≤5.	-/60/60		-/60/60
		Copper Pipe up to 50.8mm OD with minimum 25mm thick FR lagging	-/60/60		-/60/60
		Copper Pipe up to 50.8mm OD uninsulated	-/60/60		-/60/-
		Steel Sprinkler Pipe up to 60.3mm OD	-/60/60		-/60/60
		Combustible Pipes			
		PEX & PEX-AL-PEX Pipes up to 25mm Dia. with or without lagging.	-/60/60		-/60/60
		uPVC Pipe & Conduit up to 55.8mm OD	-/60/60		-/60/60
		cPVC Pipe up to 60.3mm OD	-/60/60		-/60/60
		PE-RT Pipe or PE-RT Kelox pipe up to 32mm OD with or without lagging	-/60/60		-/60/-
		Electrical Cables			
		**Appendix D1 Power Cables (except 630mm ²)	-/60/60		-/60/60
		Multi Core Power Cables: Individual conductor up to 16mm ² . Total Maximum cross-sectional area not greater than 48mm ² per cable.	-/60/60		-/60/60
		**Appendix D2 Data / Comms Cables also including: CAT5, CAT5E, CAT6, CAT7, COAX, MATV, SMATV, CATV, Fig 8, Fire Alarm, EWIS, LAN, Security, NBN, Fibre Optic & speaker cables.	-/60/60		-/60/60
		Cables with Aluminium core 185mm ² or less	-/60/60		-/60/30

*For more information refer to Minimum Fill Rates on page 16.

**In preceding table it refers to Appendix D Cables. Please refer to AS1530.4: 2014 Appendix D. The cables referenced in Appendix D are a standard set of power and communications cables that represent the various cable types available within Australia and New Zealand.

Table 3. Wall Systems with a 90min Fire Rating

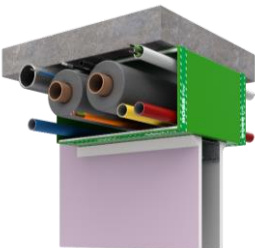
Product Description	Wall elements with an established FRL of 90/90/90 or -/90/90.	Service Penetration	FRL With P40-MAK Wrap	FRL Without P40-MAK Wrap *Minimum fill rates may apply.	Report Reference
It is considered that any combination of the below Approved Services, and any number of these Approved Services in the BOSS FyreBox™, will achieve an FRL in accordance with the least performing Approved Element or Approved Service from the below table provided that the FyreBox™ is not overfilled to a point where the metal chassis bends, flexes, or bows from overfilling. The internal Intumescent Sachets & BrushSeals™ must also not be removed or damaged.					
BOSS FyreBox™	Walls (Minimum 100mm Thick): <ul style="list-style-type: none"> • Steel or Timber Framed Fire Rated Plasterboard Lined Walls • Blank Infill Panel of BOSS Batt • Concrete • Solid or Hollow Masonry • AAC & Hebel • Speedpanel, Korok & Supapanel • Pronto Panel • Dincel • AFS • Shaftliner / Shaftwall • Partwall / Party Wall • IntRwall • Barrierline • INEX Wall Systems • AlphaPanel Wall Systems <p>Where wall is less than 100mm it may be increased by locally applied lining:</p> <ul style="list-style-type: none"> • Fire Rated Plasterboard • BOSS Batts <p>Refer item 5. Page 31 for more information.</p> 	Metal Pipes			Branz FC12925 Issue 7
		Paircoil up to 13/19mm insulated copper Pipes	-/90/90	-/90/90	
		Copper Pipe up to 25mm OD with minimum 13mm thick non-combustible lagging AS1530.1 or Armaflex FRV, K-Flex lagging or Thermobreak Lagging or similar elastomeric foam rubber such as nitrile, neoprene, or cross-linked polyolefin with density from 25kg/m ³ to 75kg/m ³ and complying with AS 1530.3, SFI=0 and SDI≤5.	-/90/90	-/90/60	
		Copper Pipe up to 32mm OD with minimum 19mm thick Armaflex FRV, K-Flex lagging or Thermobreak Lagging or similar elastomeric foam rubber such as nitrile, neoprene, or cross-linked polyolefin with density from 25kg/m ³ to 75kg/m ³ and complying with AS 1530.3, SFI=0 and SDI≤5.	-/90/90	-/90/90	
		Copper Pipe up to 50.8mm OD with minimum 25mm thick FR lagging	-/90/90	-/90/60	
		Copper Pipe up to 50.8mm OD uninsulated	-/90/90	-/90/-	
		Steel Sprinkler Pipe up to 60.3mm OD	-/90/90	-/90/90	
		Combustible Pipes			
		PEX & PEX-AL-PEX Pipes up to 25mm Dia. with or without lagging.	-/90/90	-/90/90	
		uPVC Pipe & Conduit up to 55.8mm OD	-/90/90	-/90/90	
		cPVC Pipe up to 60.3mm OD	-/90/90	-/90/90	
		PE-RT Pipe or PE-RT Kelox pipe up to 32mm OD with or without lagging	-/90/90	-/90/-	
		Electrical Cables			
		**Appendix D1 Power Cables (except 630mm ²)	-/90/90	-/90/60	
		Multi Core Power Cables: Individual conductor up to 16mm ² . Total Maximum cross-sectional area not greater than 48mm ² per cable.	-/90/90	-/90/90	
**Appendix D2 Data / Comms Cables also including: CAT5, CAT5E, CAT6, CAT7, COAX, MATV, SMATV, CATV, Fig 8, Fire Alarm, EWIS, LAN, Security, NBN, Fibre Optic & speaker cables.	-/90/90	-/90/90			
Cables with Aluminium core 185mm ² or less	-/90/90	-/90/30			

*For more information refer to Minimum Fill Rates on page 16.

**In preceding table it refers to Appendix D Cables. Please refer to AS1530.4: 2014 Appendix D. The cables referenced in Appendix D are a standard set of power and communications cables that represent the various cable types available within Australia and New Zealand.

Table 4. Wall Systems with a 120min Fire Rating

Product Description	Wall elements with an established FRL of 120/120/120 or -/120/120.	Service Penetration	FRL With P40-MAK Wrap	FRL Without P40-MAK Wrap *Minimum fill rates may apply.	Report Reference
<p>It is considered that any combination of the below Approved Services, and any number of these Approved Services in the BOSS FyreBox™, will achieve an FRL in accordance with the least performing Approved Element or Approved Service from the below table provided that the FyreBox™ is not overfilled to a point where the metal chassis bends, flexes, or bows from overfilling. The internal Intumescent Sachets & BrushSeals™ must also not be removed or damaged.</p>					
BOSS FyreBox™	Walls (Minimum 100mm Thick): <ul style="list-style-type: none"> Steel or Timber Framed Fire Rated Plasterboard Lined Walls Blank Infill Panel of BOSS Batt Concrete Solid or Hollow Masonry AAC & Hebel Speedpanel, Korok & Supanel Pronto Panel Dincel AFS Shaftliner / Shaftwall Partiwall / Party Wall IntRwall Barrierline INEX Wall Systems AlphaPanel Wall Systems <p>Where wall is less than 100mm it may be increased by locally applied lining:</p> <ul style="list-style-type: none"> Fire Rated Plasterboard BOSS Batts <p>Refer item 5. Page 31 for more information.</p> 	Metal Pipes			Brnz FC12925 Issue 7
		Paircoil up to 13/19mm insulated copper Pipes	-/120/120	-/120/90	
		Copper Pipe up to 25mm OD with minimum 13mm thick non-combustible lagging AS1530.1 or Armaflex FRV, K-Flex lagging or Thermobreak Lagging or similar elastomeric foam rubber such as nitrile, neoprene, or cross-linked polyolefin with density from 25kg/m ³ to 75kg/m ³ and complying with AS 1530.3, SFI=0 and SDI≤5.	-/120/120	-/120/60	
		Copper Pipe up to 32mm OD with minimum 19mm thick Armaflex FRV, K-Flex lagging or Thermobreak Lagging or similar elastomeric foam rubber such as nitrile, neoprene, or cross-linked polyolefin with density from 25kg/m ³ to 75kg/m ³ and complying with AS 1530.3, SFI=0 and SDI≤5.	-/120/120	-/120/120	
		Copper Pipe up to 50.8mm OD with minimum 25mm thick FR lagging	-/120/120	-/120/60	
		Copper Pipe up to 50.8mm OD uninsulated	-/120/120	-/120/-	
		Steel Sprinkler Pipe up to 60.3mm OD	-/120/120	-/120/120	
		Combustible Pipes			
		PEX & PEX-AL-PEX Pipes up to 25mm Dia. with or without lagging.	-/120/120	-/120/90	
		uPVC Pipe & Conduit up to 55.8mm OD	-/120/120	-/120/120	
		cPVC Pipe up to 60.3mm OD	-/120/120	-/120/120	
		PE-RT Pipe or PE-RT Kelox pipe up to 32mm OD with or without lagging	-/120/120	-/120/-	
		Electrical Cables			
		**Appendix D1 Power Cables (except 630mm ²)	-/120/120	-/120/60	
		Multi Core Power Cables: Individual conductor up to 16mm ² . Total Maximum cross-sectional area not greater than 48mm ² per cable.	-/120/120	-/120/90	
		**Appendix D2 Data / Comms Cables also including: CAT5, CAT5E, CAT6, CAT7, COAX, MATV, SMATV, CATV, Fig 8, Fire Alarm, EWIS, LAN, Security, NBN, Fibre Optic & speaker cables.	-/120/120	-/120/90	
		Cables with Aluminium core 185mm ² or less	-/120/120	-/120/30	

*For more information refer to Minimum Fill Rates on page 16.

**In preceding table it refers to Appendix D Cables. Please refer to AS1530.4: 2014 Appendix D. The cables referenced in Appendix D are a standard set of power and communications cables that represent the various cable types available within Australia and New Zealand.

Table 5. Concrete Slab & Floor / Ceiling Systems with a 60min Fire Rating

Product Description	Concrete Slab & Floor / Ceiling elements with an established FRL of 60/60/60 or -/60/60.	Service Penetration	FRL With P40-MAK Wrap	Report Reference	
<p>It is considered that any combination of the below Approved Services, and any number of these Approved Services in the BOSS FyreBox™, will achieve an FRL in accordance with the least performing Approved Element or Approved Service from the below table provided that the FyreBox™ is not overfilled to a point where the metal chassis bends, flexes, or bows from overfilling. The internal Intumescent Sachets & BrushSeals™ must also not be removed or damaged.</p>					
BOSS FyreBox™	Floors: <ul style="list-style-type: none"> Concrete Floor Slabs Minimum 70mm Thick Fire Rated Ceiling / Floor Systems <ul style="list-style-type: none"> Consisting of fire rated plasterboard and timber floor structure minimum 235mm thick. 	Metal Pipes		Branz FC12925 Issue 7	
		Paircoil up to 13/19mm insulated copper Pipes	-/60/60		
		Copper Pipe up to 25mm OD with minimum 13mm thick non-combustible lagging AS1530.1 or Armaflex FRV, K-Flex lagging or Thermobreak Lagging or similar elastomeric foam rubber such as nitrile, neoprene, or cross-linked polyolefin with density from 25kg/m ³ to 75kg/m ³ and complying with AS 1530.3, SFI=0 and SDI≤5.	-/60/60		
		Copper Pipe up to 32mm OD with minimum 19mm thick Armaflex FRV, K-Flex lagging or Thermobreak Lagging or similar elastomeric foam rubber such as nitrile, neoprene, or cross-linked polyolefin with density from 25kg/m ³ to 75kg/m ³ and complying with AS 1530.3, SFI=0 and SDI≤5.	-/60/60		
		Copper Pipe up to 50.8mm OD with minimum 25mm thick FR lagging	-/60/60		
		Copper Pipe up to 50.8mm OD uninsulated	-/60/60		
		Steel Sprinkler Pipe up to 60.3mm OD	-/60/60		
		Combustible Pipes			
		uPVC Pipe & Conduit up to 25mm OD	-/60/60		
		Electrical Cables			
		**Appendix D1 Power Cables (except 630mm ²)	-/60/60		
		Multi Core Power Cables: Individual conductor up to 16mm ² . Total Maximum cross-sectional area not greater than 48mm ² per cable.	-/60/60		
		**Appendix D2 Data / Comms Cables also including: CAT5, CAT5E, CAT6, CAT7, COAX, MATV, SMATV, CATV, Fig 8, Fire Alarm, EWIS, LAN, Security, NBN, Fibre Optic & speaker cables.	-/60/60		
		Cables with Aluminium core 185mm ² or less	-/60/60		

***In preceding table it refers to Appendix D Cables. Please refer to AS1530.4: 2014 Appendix D. The cables referenced in Appendix D are a standard set of power and communications cables that represent the various cable types available within Australia and New Zealand.*

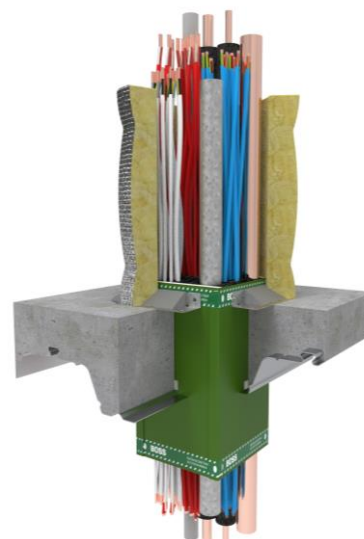

Table 6. Concrete Slab & Floor / Ceiling Systems with a 90min Fire Rating

Product Description	Concrete Slab & Floor / Ceiling elements with an established FRL of 90/90/90 or -/90/90.	Service Penetration	FRL With P40-MAK Wrap	Report Reference
It is considered that any combination of the below Approved Services, and any number of these Approved Services in the BOSS FyreBox™, will achieve an FRL in accordance with the least performing Approved Element or Approved Service from the below table provided that the FyreBox™ is not overfilled to a point where the metal chassis bends, flexes, or bows from overfilling. The internal Intumescent Sachets & BrushSeals™ must also not be removed or damaged.				
BOSS FyreBox™	Floors: <ul style="list-style-type: none"> Concrete Floor Slabs Minimum 110mm Thick Fire Rated Ceiling / Floor Systems <ul style="list-style-type: none"> Consisting of fire rated plasterboard and timber floor structure minimum 235mm thick. 	Metal Pipes		Branz FC12925 Issue 7
		Paircoil up to 13/19mm insulated copper Pipes	-/90/90	
		Copper Pipe up to 25mm OD with minimum 13mm thick non-combustible lagging AS1530.1 or Armaflex FRV, K-Flex lagging or Thermobreak Lagging or similar elastomeric foam rubber such as nitrile, neoprene, or cross-linked polyolefin with density from 25kg/m ³ to 75kg/m ³ and complying with AS 1530.3, SFI=0 and SDI≤5.	-/90/90	
		Copper Pipe up to 32mm OD with minimum 19mm thick Armaflex FRV, K-Flex lagging or Thermobreak Lagging or similar elastomeric foam rubber such as nitrile, neoprene, or cross-linked polyolefin with density from 25kg/m ³ to 75kg/m ³ and complying with AS 1530.3, SFI=0 and SDI≤5.	-/90/90	
		Copper Pipe up to 50.8mm OD with minimum 25mm thick FR lagging	-/90/90	
		Copper Pipe up to 50.8mm OD uninsulated	-/90/90	
		Steel Sprinkler Pipe up to 60.3mm OD	-/90/90	
		Combustible Pipes		
		uPVC Pipe & Conduit up to 25mm OD	-/90/90	
		Electrical Cables		
		**Appendix D1 Power Cables (except 630mm ²)	-/90/90	
		Multi Core Power Cables: Individual conductor up to 16mm ² . Total Maximum cross-sectional area not greater than 48mm ² per cable.	-/90/90	
		**Appendix D2 Data / Comms Cables also including: CAT5, CAT5E, CAT6, CAT7, COAX, MATV, SMATV, CATV, Fig 8, Fire Alarm, EWIS, LAN, Security, NBN, Fibre Optic & speaker cables.	-/90/90	
Cables with Aluminium core 185mm ² or less	-/90/90			

**In preceding table it refers to Appendix D Cables. Please refer to AS1530.4: 2014 Appendix D. The cables referenced in Appendix D are a standard set of power and communications cables that represent the various cable types available within Australia and New Zealand.



Table 7. Concrete Slab & Floor / Ceiling Systems with a 120min Fire Rating

Product Description	Concrete Slab & Floor / Ceiling elements with an established FRL of 120/120/120 or -/120/120.	Service Penetration	FRL With P40-MAK Wrap	Report Reference
<p>It is considered that any combination of the below Approved Services, and any number of these Approved Services in the BOSS FyreBox™, will achieve an FRL in accordance with the least performing Approved Element or Approved Service from the below table provided that the FyreBox™ is not overfilled to a point where the metal chassis bends, flexes, or bows from overfilling. The internal Intumescent Sachets & BrushSeals™ must also not be removed or damaged.</p>				
BOSS FyreBox™	Floors: <ul style="list-style-type: none"> Concrete Floor Slabs Minimum 110mm Thick Fire Rated Ceiling / Floor Systems <ul style="list-style-type: none"> Consisting of fire rated plasterboard and timber floor structure minimum 235mm thick. 	Metal Pipes		Branz FC12925 Issue 7
		Paircoil up to 13/19mm insulated copper Pipes	-/120/120	
		Copper Pipe up to 25mm OD with minimum 13mm thick non-combustible lagging AS1530.1 or Armaflex FRV, K-Flex lagging or Thermobreak Lagging or similar elastomeric foam rubber such as nitrile, neoprene, or cross-linked polyolefin with density from 25kg/m ³ to 75kg/m ³ and complying with AS 1530.3, SFI=0 and SDI≤5.	-/120/120	
		Copper Pipe up to 32mm OD with minimum 19mm thick Armaflex FRV, K-Flex lagging or Thermobreak Lagging or similar elastomeric foam rubber such as nitrile, neoprene, or cross-linked polyolefin with density from 25kg/m ³ to 75kg/m ³ and complying with AS 1530.3, SFI=0 and SDI≤5.	-/120/120	
		Copper Pipe up to 50.8mm OD with minimum 25mm thick FR lagging	-/120/120	
		Copper Pipe up to 50.8mm OD uninsulated	-/120/120	
		Steel Sprinkler Pipe up to 60.3mm OD	-/120/120	
		Electrical Cables		
		**Appendix D1 Power Cables (except 630mm ²)	-/120/120	
		Multi Core Power Cables: Individual conductor up to 16mm ² . Total Maximum cross-sectional area not greater than 48mm ² per cable.	-/120/120	
		**Appendix D2 Data / Comms Cables also including: CAT5, CAT5E, CAT6, CAT7, COAX, MATV, SMATV, CATV, Fig 8, Fire Alarm, EWIS, LAN, Security, NBN, Fibre Optic & speaker cables.	-/120/120	
		Cables with Aluminium core 185mm ² or less	-/120/120	
		BOSS FyreBox™	Floors: <ul style="list-style-type: none"> Concrete Floor Slabs Minimum 110mm Thick 	
uPVC Pipe & Conduit up to 25mm OD	-/120/120			

**In preceding table it refers to Appendix D Cables. Please refer to AS1530.4: 2014 Appendix D. The cables referenced in Appendix D are a standard set of power and communications cables that represent the various cable types available within Australia and New Zealand.

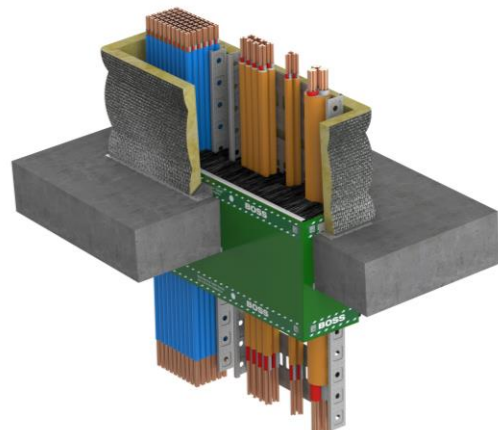
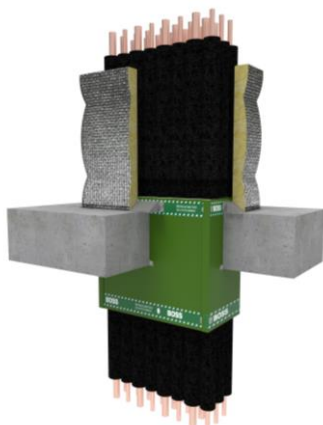

BOSS FyreBox™ Size Selection

The BOSS FyreBox™ is designed specifically to house bundles of penetrating services, either of the same in material type and size, or of multiple compositions from the Approved Services shown in Tables 2-7 on pages 10-15. It is not designed for blank openings, therefore if your requirement is to fill a blank aperture in a fire rated wall or floor that contains no penetrating services, you must use other sealing systems, which are also low cost and simple to install.

You must select the smallest size BOSS FyreBox™ available that your installation and configuration requires. Penetrations in fire rated barriers can also weaken the fire integrity of an Approved Element. Therefore, you must always minimise the size of apertures in accordance with the Approved Element specifications.

Standard sizes available of BOSS FyreBoxes include:

- BFB-150 - (150mm W x 150mm H x 270mm D)
- BFB-150-XD - (150mm W x 150mm H x 270mm D)
- BFB-200 – (200mm W x 150mm H x 270mm D)
- BFB-300 - (300mm W x 150mm H x 270mm D)
- BFB-300-XD (300mm W x 150mm H x 450mm D)
- BFB-450 - (450mm W x 150mm H x 270mm D)
- BFB-450-SL - (450mm W x 100mm H x 270mm D)
- BFB-550 - (550mm W x 150mm H x 270mm D)
- BFB-600 - (600mm W x 150mm H x 270mm D)
- BFB-600 - (600mm W x 150mm H x 270mm D)
- BFB-600-XD - (600mm W x 150mm H x 450mm D)
- BFB-750 - (750mm W x 150mm H x 270mm D)
- BFB-900 – (900mm W X 150mm H x 270mm D)
- BFB-JR - (200mm W x 110mm H x 150mm D)

Minimum Fill Rates

For unwrapped service configurations in approved wall systems pursuant to Branz FC12925 Issue 7 the BOSS FyreBox™ must maintain a minimum fill rate of 14% in all FyreBoxes larger than the BFB-150 or sizes with an opening <math><22,500\text{mm}^2</math>. For the BFB-150 BOSS FyreBox™, or FyreBoxes with an opening of <math><22,500\text{mm}^2</math>, minimum fill rates do not apply.

'Fill rates' are calculated by adding up the total Cross-Sectional Area (CSA) of all services penetrating the FyreBox™ divided by the total CSA inside the FyreBox™, expressed as a percentage. Please contact BOSS Fire for assistance in calculating minimum fill rates.

Services Spacing Requirements

Branz FC12925 Issue 7 specifies that only the Approved Services may be in any combination in any number in the BOSS FyreBox™ provided that the internal Intumescent Sachets or BrushSeals™ **are not** removed or damaged, and that the quantity of Approved Services fit neatly in the FyreBox™ and are not overfilled to a point where the metal chassis bends, flexes or bows. Other Australian Standards such as AS5601-2004 Gas Installations & AS3500-2003 Plumbing & Drainage contain requirements for separation of various services. Some examples of these may include:

- There shall be at least 25mm separation between any consumer gas piping and any above ground:
 - Metal electrical conduit
 - Electrical wire or cable not in a conduit
 - Electrical earthing electrode
- At least 25mm shall be maintained between any above ground water service and any of the following:
 - Electrical Conduits
 - Electrical Wires or cables
 - Consumer Gas Pipes
 - Sanitary plumbing and drainage
- Above ground pipework associated with heated water services shall not be installed within 100mm of electrical cables, gas pipes or other services.

You must consult with your certifying authority, local building authorities and all relevant trade Australian Standards to confirm your spacing requirements.

Project Shop Drawing

We recommend for projects where multiple service trades are utilising the BOSS FyreBox™ for there to be a project-specific shop drawing to ensure the consistency & correct placement and spacings of services within the BOSS FyreBox™.

You must consult with your certifying authority and all relevant trade Australian Standards to confirm your spacing requirements.

Trapeze

An internal Trapeze is provided inside the FyreBox™ for aiding separation between services. You must confirm your services are spaced in accordance with Australian Standards. Where separation is required, such as between power & data cables, gas or hot/cold water services, space the services in the FyreBox™. (Refer to Services Spacing Requirements on page 16 for more information). Tie the services into position using plastic cable ties where necessary. Services must be independently supported on both sides of the BOSS FyreBox™ ensuring no weight is transferred from services to the FyreBox™. Removal of the Trapeze is not detrimental to the performance of the BOSS FyreBox™. To remove the Trapeze unscrew the two Trapeze mounting bolts by unscrewing in an anticlockwise fashion.

You must consult with your certifying authority and all relevant trade Australian Standards to confirm your spacing requirements.



Awards

The BOSS FyreBox™ is a MULTI-AWARD winning innovation that has revolutionised the passive fire industry. Awards received include:

- **2017 Fire Protection Industry Awards:**
 - Project of the Year Award Under \$1 Million in conjunction with Multiplex - Capitol Grand
- **2018 Australian Construction Awards:**
 - Product Innovation of the Year
- **2021 Good Design Awards:**
 - Product Design – Building & Hardware
 - Engineering Design



Installation – Head of Wall / Soffit Mount – Framed Walls

The below sequence outlines the steps to install a BOSS FyreBox™ to the head of wall /soffit mount of framed wall systems with an established Fire Resistance Level (FRL). Further construction details related to this method of installation and BOSS Batt infill panel can be found on pages 22, 23 & 24.

1. Remove base piece of the FyreBox™ by removing four M5 screws.

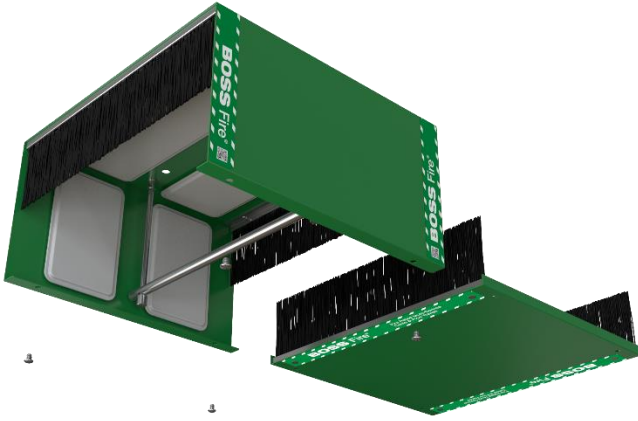

2. Mark the fixing position of the FyreBox™ on the soffit.

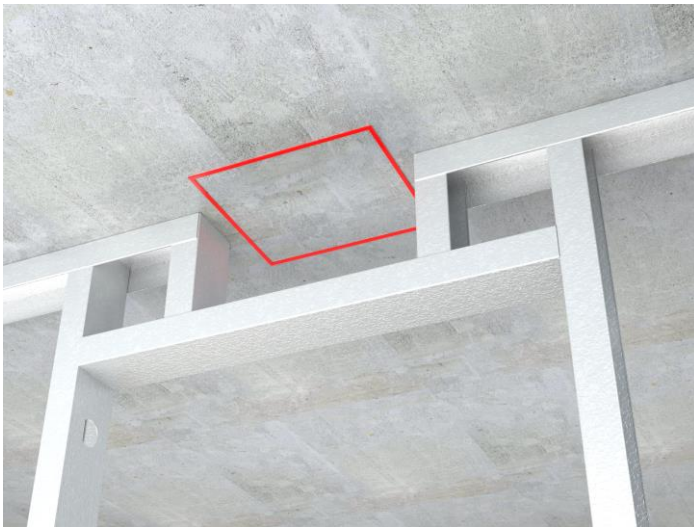

3. Apply 10mm bead of FireMastic-300™ sealant around the perimeter of the top of the FyreBox™ and a 10mm bead located centrally from left to right. (Non-brush face to non-brush face).

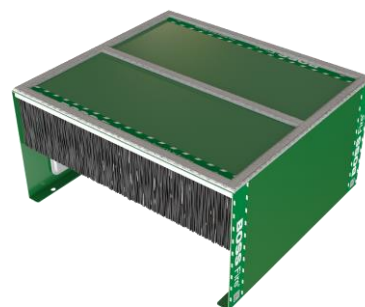

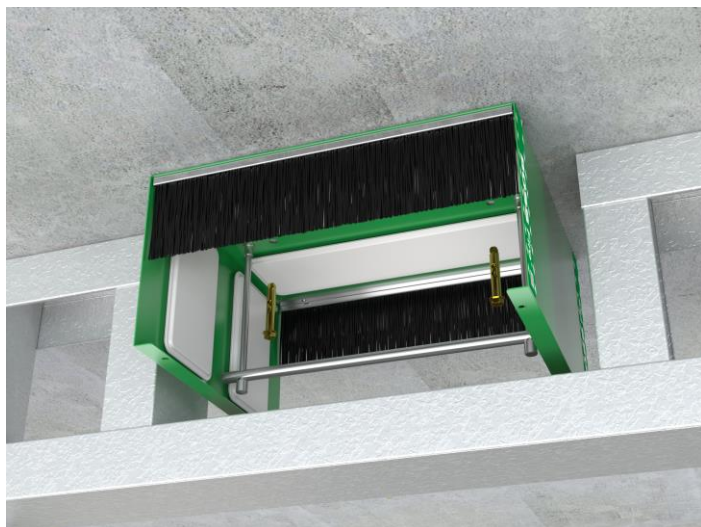

- Fix the FyreBox™ to the underside of the soffit via mounting holes in the top plate. Use all steel masonry anchors, minimum M6 x 40mm.

Note that for FyreBoxes with a greater width than 450mm wide, additional fixings are required. Ensure fixings are maximum 200mm centres apart across the width of the FyreBox™ to soffit or noggin in a mid-wall mount application.

Note: Alternatively a minimum 20mm x 20mm x 1mm flanged bracket can be used around the perimeter to hold the FyreBox™ in place on one side of the wall only. If using in a soffit mount application the flanged bracket shall be required on three sides only. (Both sides and underside).

Table 5. Fixings – Soffit Mount

BOSS FyreBox™ Size	Min No. of Fixings Req.
BFB-150 - (150mm W x 150mm H x 270mm D)	2
BFB-300 - (300mm W x 150mm H x 270mm D)	2
BFB-450 - (450mm W x 100mm H x 270mm D)	2
BFB-550 - (550mm W x 150mm H x 270mm D)	3
BFB-600 - (600mm W x 150mm H x 270mm D)	3
BFB-900 - (900mm W x 150mm H x 270mm D)	5
Fixing Type	Min Size
All steel masonry anchors	M6 x 40mm

Fixings to be maximum 200mm Centres.

Refer to table on left hand side to determine the minimum quantity of fixings required relevant to the size of product.

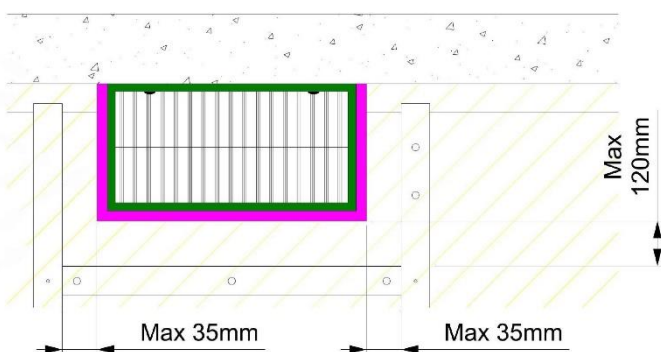

- If mounting into a framed or flexible wall, such as steel stud and plasterboard, ensure the wall is framed in accordance with the established framing requirements of the wall system including position of trimmer studs, noggins and/or full-length studs. Notwithstanding the FyreBox™ must be located no more than 35mm from the nearest stud or trimmer stud, and no more than 120mm from the nearest noggin. Consult the technical manual of the provider of the wall system for full further details.

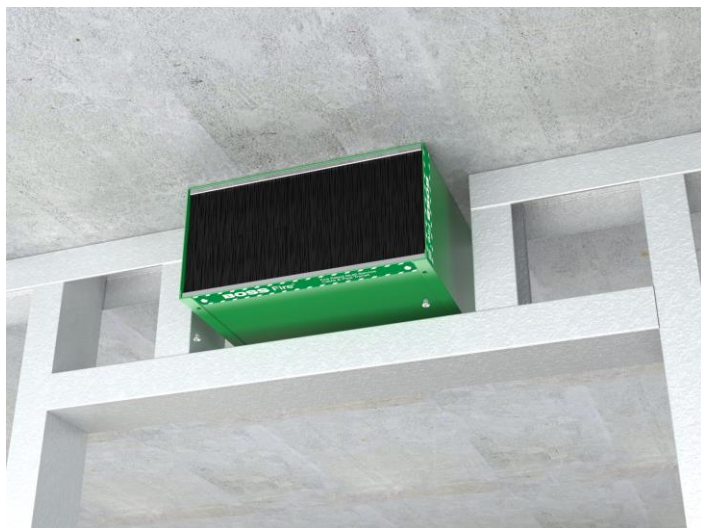

- Slide the base piece back into the FyreBox™ and fit the M5 screws.



- Apply **BOSS FireMastic-300™** to the perimeter of the FyreBox™ where it interfaces with the wall lining, on both sides of the wall. Apply sealant to the full depth of plasterboard lining x maximum 20mm wide annular gap.



- The **BOSS FireMastic-300™** must then be finished with a 15 x 15mm fillet around the perimeter of the FyreBox™.

For a neat finish you can optionally measure and mark the size of the fillet by temporarily applying masking tape to the wall & FyreBox™ to control the size of the fillet and provide a neat finish for aesthetic purposes. Masking tape to be removed once sealant applied.

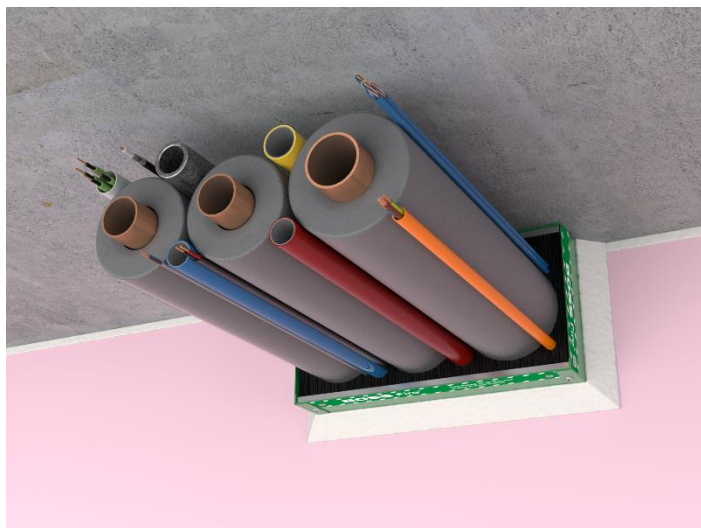

9. Approved Services can begin to be installed through the FyreBox™ after it has been fixed into place ensuring that the services are Approved Services and system is in accordance with Tables 2, 3 or 4 on pages 10, 11 or 12.

(The FyreBox™ must not be overfilled to a point where the metal chassis bends, flexes, or bows from overfilling. The internal Intumescent Sachets & BrushSeals™ must not be removed or damaged. For FyreBoxes larger than a BFB-150 minimum fill rates apply when installing unwrapped systems. Refer to Minimum Fill Rates on page 16).

Note: All services must be supported independently both sides of the BOSS FyreBox™ to ensure no weight is transferred from services to the FyreBox™.

The use of the **P40-MAK Wrap** (300mm wide thermal wrap) may or may not be required dependant on services passing through the FyreBox™ and FRL required. For more information refer to Tables 2, 3 & 4 on pages 10, 11 & 12.

If **P40-MAK Wrap** is required, follow these additional steps:

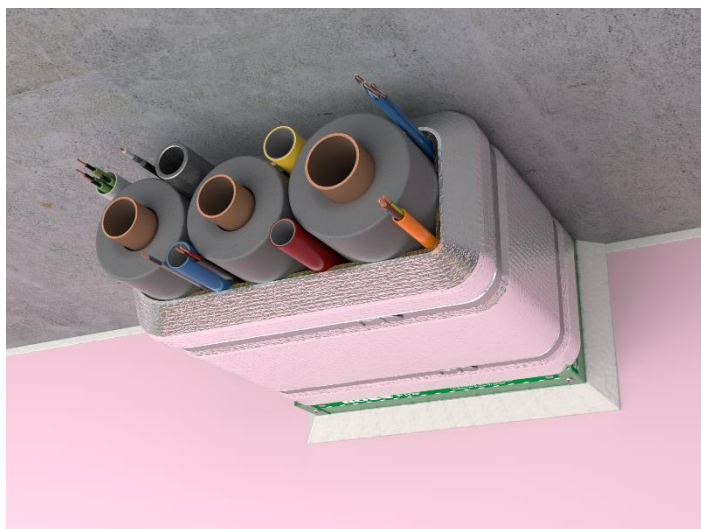

10. The use of the **P40-MAK Wrap** will provide an increased FRL in the form of higher insulation values up to 120 minutes. Fit **P40 MAK-Wrap** (300mm wide) thermal wrap to both sides of the wall. To apply the **BOSS P40 MAK-Wrap**:
- Place the **P40-MAK Wrap** on the services and wrap all the way around the bundled services, overlapping the previous layer by 90 degrees and use aluminium foil tape to hold the end of the wrap in place prior to ties being fitted.
 - Use steel cable ties to tightly secure the wrap to the services. Use a minimum of 2 ties nominally 50mm in from each end of the wrap.
 - Lastly, use aluminium foil tape to cover exposed mineral fibres between the foil backing and the services at the open ends of the wrap for a neat aesthetic finish.
 - Repeat process on other side of the wall.

Note: In accordance with clause 4.9.3 of AS4072.1-2005 separating services can be fitted in a modular form in the approved construction element with minimum 40mm separation, unless tested otherwise. Therefore, mixed services can be bundled within the BOSS FyreBox™ however 40mm separation must be maintained from other external services, or additional BOSS FyreBoxes and of course the configuration must be in accordance with Tables 2, 3 or 4 on pages 10, 11 or 12.

Note that AS5601 Gas Installations & AS3500 Plumbing & Drainage also calls for separation between some services and the requirements of these Standards must be followed if these services exist within your installation or configuration.

For more information, please refer to following construction details for clarity on above sequence installation or contact BOSS Fire® on 1300 502 677 or info@bossfire.com.au.

Construction Details – Head of Wall / Soffit Mount – Framed Walls

The below details are in addition to the preceding sequence steps for clarity of components and installation techniques.

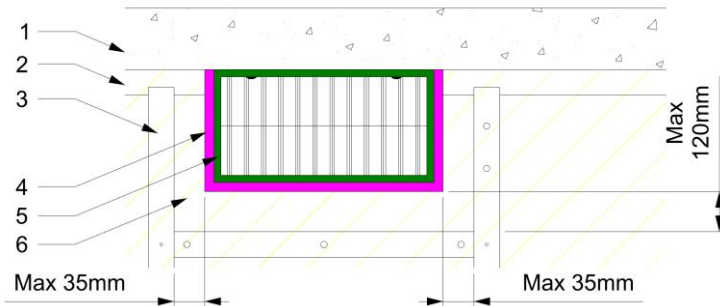

Framing Elevation 1.

1. Concrete Soffit
2. Deflection Track
3. Steel or Timber Stud Framing / Trimmer Stud Framing BOSS FyreBox™
4. FireMastic-300™
5. BOSS FyreBox™
6. Fire Rated Plasterboard

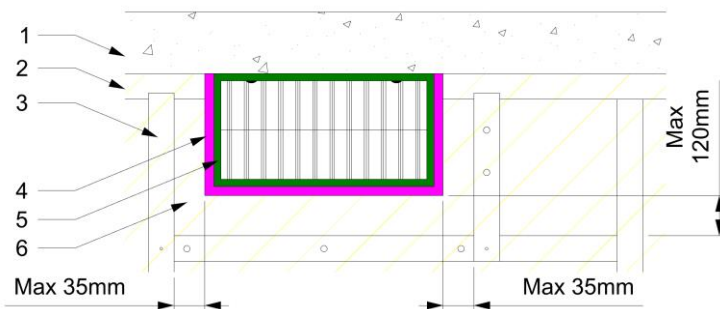

Framing Elevation 2.

1. Concrete Soffit
2. Deflection Track
3. Steel or Timber Stud Framing / Trimmer Stud Framing BOSS FyreBox™
4. FireMastic-300™
5. BOSS FyreBox™
6. Fire Rated Plasterboard

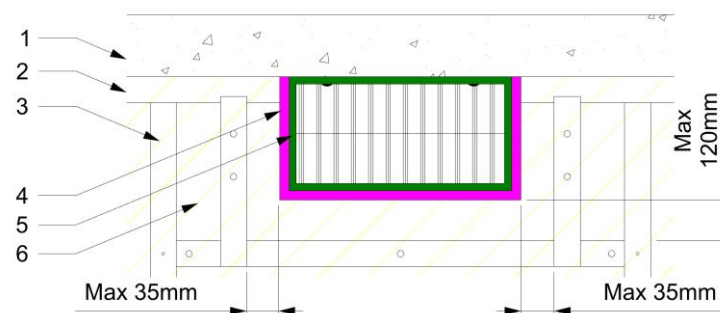

Framing Elevation 3.

1. Concrete Soffit
2. Deflection Track
3. Steel or Timber Stud Framing / Trimmer Stud Framing BOSS FyreBox™
4. FireMastic-300™
5. BOSS FyreBox™
6. FR Plasterboard

The below details are in addition to the preceding sequence steps for clarity of components and installation techniques.

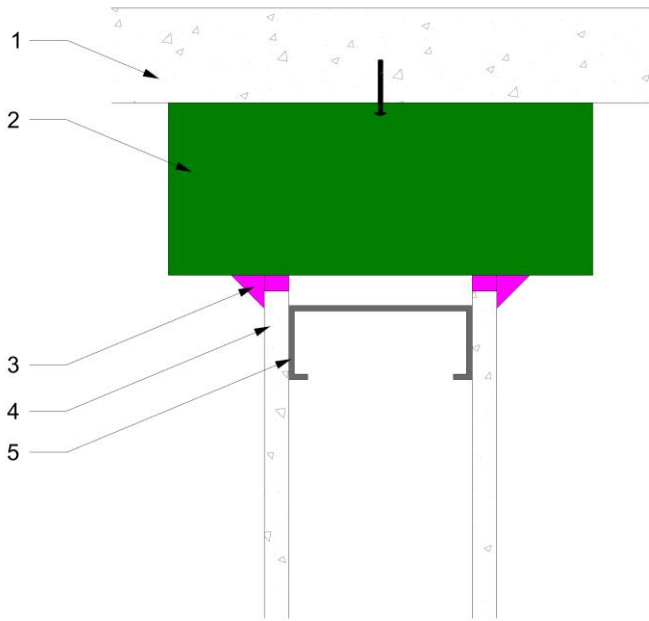

Framing Section.

1. Concrete Soffit
2. BOSS FyreBox™
3. FireMastic-300™
4. Fire Rated Plasterboard Lining
5. Steel or Timber Stud Framing / Noggin

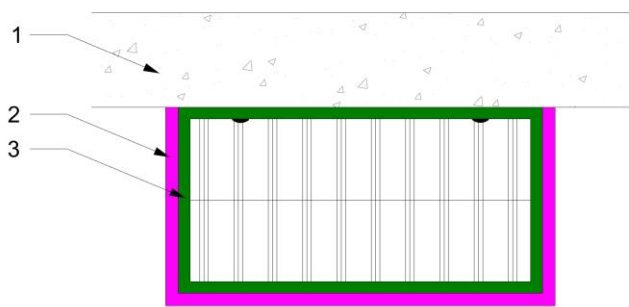

Elevation with Lining.

1. Concrete Soffit
2. FireMastic-300™
3. BOSS FyreBox™

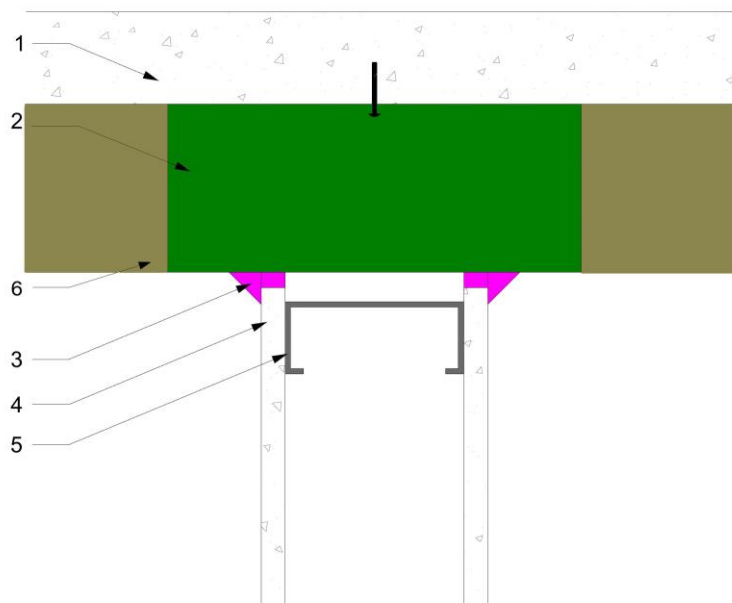

Framing Section with P40-MAK Wrap.

1. Concrete Soffit
2. BOSS FyreBox™
3. FireMastic-300™
4. Fire Rated Plasterboard Lining
5. Steel or Timber Stud Framing / Noggin
6. P40-MAK Wrap

Construction Details – BOSS Batt – Head of Wall / Soffit Mount Infill Panel in Framed Wall Systems – 60, 90 & 120min Requirements

The below details outline the use of the BOSS FyreBox™ installed into a Soffit Mount BOSS Batt infill panel to achieve a 60, 90 & 120min FRL in framed walls.

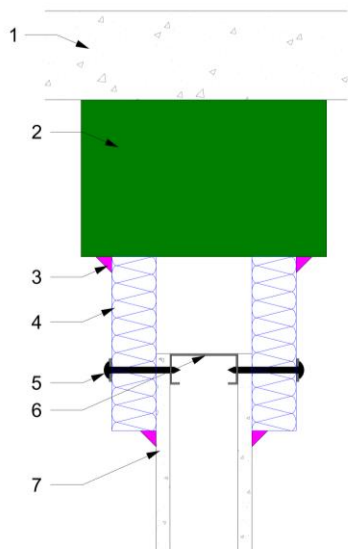

Section - Soffit Mount – BOSS Batt Infill Panel 60, 90 & 120min FRL's

1. Concrete Slab
2. BOSS FyreBox™
3. FireMastic-300™
4. BOSS Batt
5. 90mm Steel or Timber Screws with 20mm Washer
6. Steel or Timber Stud Framing / Noggin
7. Fire Rated Plasterboard

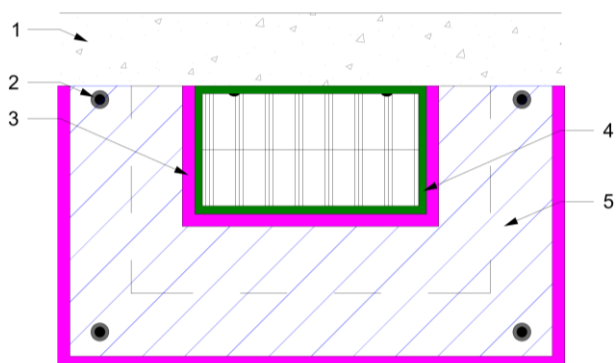

Elevation – Soffit Mount - BOSS Batt Infill Panel 60, 90 & 120min FRL's

1. Concrete Slab
2. 90mm Pig Tail Screws with 20mm Washer
3. FireMastic-300™
4. BOSS FyreBox™
5. BOSS Batt

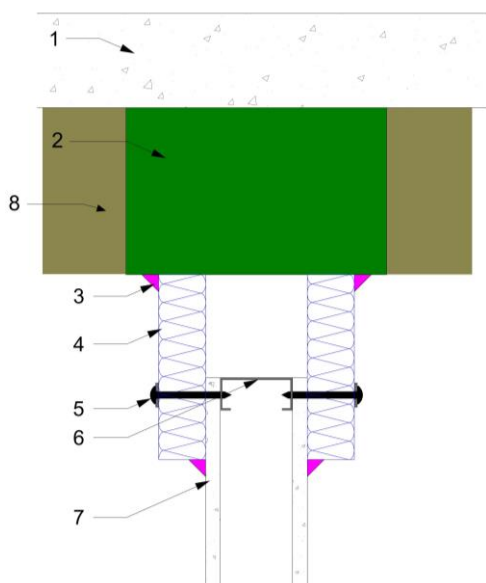

Section - Soffit Mount – BOSS Batt Infill Panel 60, 90 & 120min FRL's

1. Concrete Slab
2. BOSS FyreBox™
3. FireMastic-300™
4. BOSS Batt
5. 90mm Steel or Timber Screws with 20mm Washer
6. Steel or Timber Stud Framing / Noggin
7. Fire Rated Plasterboard

Installation – Mid Wall Mount – Framed Walls

The below sequence outlines the steps to install a BOSS FyreBox™ within framed wall systems with an established Fire Resistance Level (FRL). Further construction details related to this method of installation and BOSS Batt infill panel can be found on page 28 & 29.

1. Remove base piece of the FyreBox™ by removing four M5 screws.

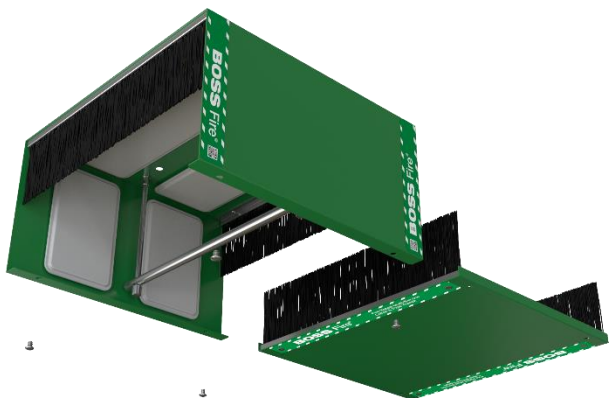

2. If mounting into a framed or flexible wall, such as steel stud and plasterboard, ensure the wall is framed in accordance with the established framing requirements of the wall system including position of trimmer studs, noggins and/or full-length studs. Notwithstanding the BOSS FyreBox™ must be located no more than 35mm from the nearest stud or trimmer stud, and no more than 120mm from the nearest noggin. Consult the technical manual of the provider of the wall system for full further details.

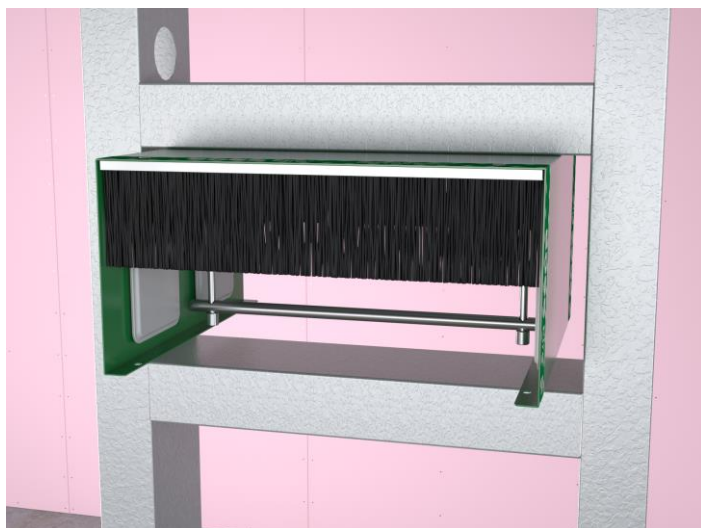

3. Fix the FyreBox™ to the underside of a noggin using 12g x 35mm self drilling screws.
 Note that for FyreBoxes with a greater width than 450mm wide, additional fixings are required. Ensure fixings are maximum 200mm centres apart across the width of the FyreBox™ to noggin in a mid-wall mount application. Refer to following Table on page 23 for more information.

Table 6. Fixings – Noggin Mount

BOSS FyreBox™ Size (mm)	Min No. Fixings Req.
BFB-150 - (150 W x 150 H x 270 D)	2
BFB-300 - (300 W x 150 H x 270 D)	2
BFB-450 - (450 W x 100 H x 270 D)	2
BFB-550 - (550 W x 150 H x 270 D)	3
BFB-600 - (600 W x 150 H x 270 D)	3
BFB-900 - (900 W x 150 H x 270 D)	5
Fixing Type	Min Size
Self Drilling Screws	12g x 35mm

Fixings to be maximum 200mm centres.

Refer to table on left hand side to determine the minimum quantity of fixings required relevant to the size of product.

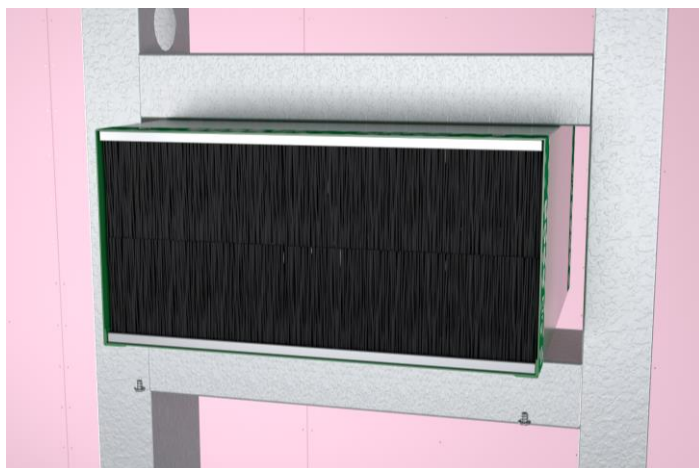

- Slide the base piece back into the FyreBox™ and fit the M5 screws.

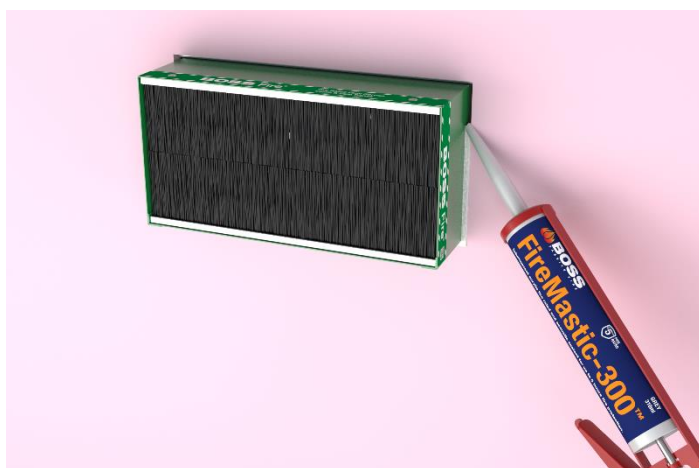

- Apply BOSS FireMastic-300™ to the perimeter of the FyreBox™ where it interfaces with the wall lining, on both sides of the wall. Apply sealant to the full depth of plasterboard lining x maximum 20mm wide annular gap.



- The BOSS FireMastic-300™ must then be finished with a 15x15mm fillet around the perimeter of the FyreBox™ to both sides of the wall.

For a neat finish you can optionally measure and mark the size of the fillet by temporarily applying masking tape to the wall & FyreBox™ to control the size of the fillet and provide a neat finish for aesthetic purposes. Masking tape to be removed once sealant applied.

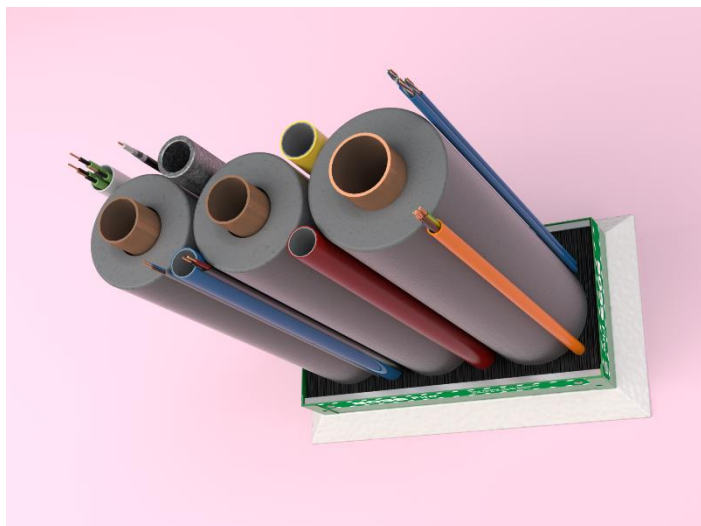

7. Approved Services can begin to be installed through the FyreBox™ after the FyreBox™ has been fixed into place ensuring that the services are Approved Services and system is in accordance with Tables 2, 3 or 4 on pages 10, 11 or 12.

(The FyreBox™ must not be overfilled to a point where the metal chassis bends, flexes, or bows from overfilling. The internal Intumescent Sachets & BrushSeals™ must not be removed or damaged. For FyreBoxes larger than a BFB-150 minimum fill rates apply when installing unwrapped systems. Refer to Minimum Fill Rates on page 16).

Note: All services must be supported independently both sides of the BOSS FyreBox™ to ensure no weight is transferred from services to the FyreBox™.

The use of the **P40-MAK Wrap** (300mm wide thermal wrap) may or may not be required dependant on services passing through the FyreBox™ and FRL required. For more information refer to Tables 2, 3 & 4 on pages 10, 11 & 12.

If **P40-MAK Wrap** is required, follow these additional steps:

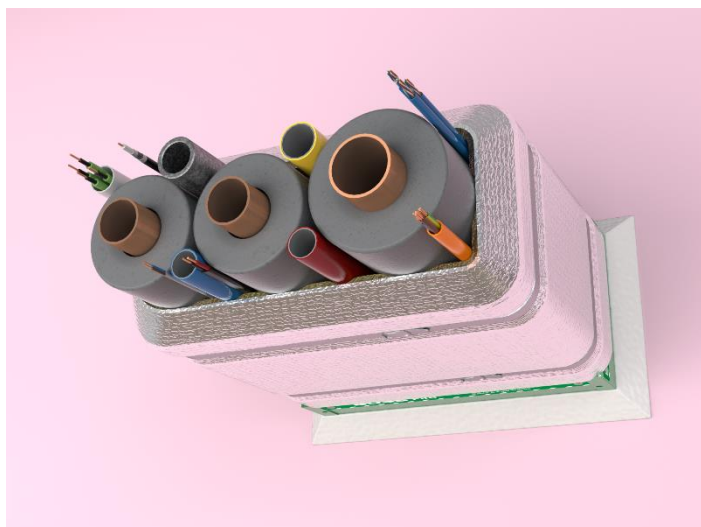

8. The use of the P40-MAK Wrap will provide an increased FRL in the form of higher insulation values up to 120 minutes. Fit P40 MAK-Wrap (300mm wide) thermal wrap to both sides of the wall. To apply the **BOSS P40 MAK-Wrap**:
 - a) Place the **P40-MAK Wrap** on the services and wrap all the way around the bundled services, overlapping the previous layer by 90 degrees and use aluminium foil tape to hold the end of the wrap in place prior to ties being fitted.
 - b) Use steel cable ties to tightly secure the wrap to the services. Use a minimum of 2 ties nominally 50mm in from each end of the wrap.
 - c) Lastly, use aluminium foil tape to cover exposed mineral fibres between the foil backing and the services at the open ends of the wrap for a neat aesthetic finish.
 - d) Repeat process on other side of the wall.

Note: In accordance with clause 4.9.3 of AS4072.1-2005 separating services can be fitted in a modular form in the approved construction element with minimum 40mm separation, unless tested otherwise. Therefore, mixed services can be bundled within the BOSS FyreBox™ however 40mm separation must be maintained from other external services, or additional BOSS FyreBoxes and of course the configuration must be in accordance with Tables 2, 3 or 4 on pages 10, 11 or 12.

Note that AS5601 Gas Installations & AS3500 Plumbing & Drainage also calls for separation between some services and the requirements of these Standards must be followed if these services exist within your installation or configuration.

For more information, please refer to following construction details for clarity on above sequence installation or contact BOSS Fire® on 1300 502 677 or info@bossfire.com.au.

Construction Details – Mid Wall Mount – Framed Walls

The below details are in addition to the preceding sequence steps for clarity of components and installation techniques.

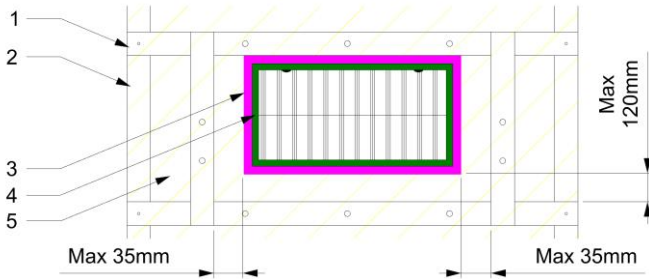

Framing Elevation 1.

1. Steel or Timber Stud Framing / Noggin
2. Steel or Timber Stud Framing / Stud
3. FireMastic-300™
4. BOSS FyreBox™
5. Fire Rated Plasterboard

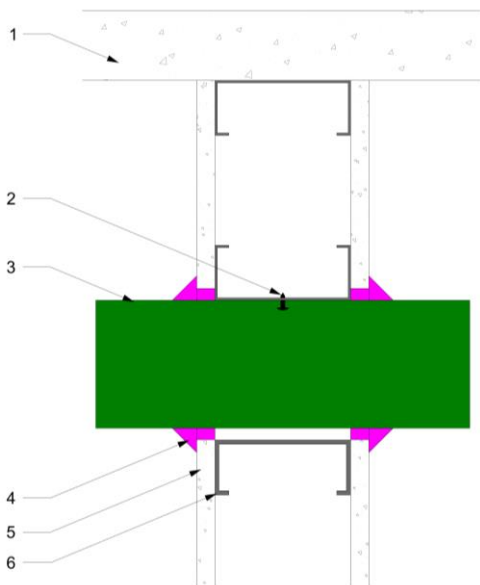

Framing Elevation 2.

1. Concrete Soffit
2. 12 Gauge x 35mm Self Drilling Screws (Refer Table 6 on Page 22 for quantity).
3. BOSS FyreBox™
4. FireMastic-300™
5. Fire Rated Plasterboard Lining
6. Steel or Timber Stud Framing / Noggin

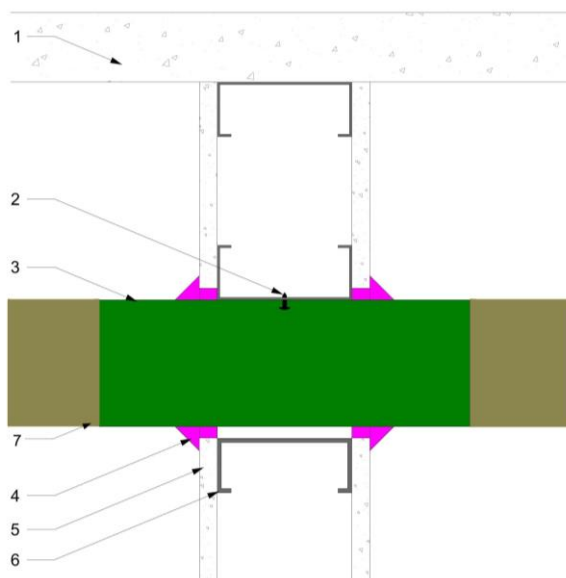

Framing Elevation with P40-MAK Wrap.

1. Concrete Soffit
2. 12 Gauge x 35mm Self Drilling Screws (Refer Table 6 on Page 22 for quantity).
3. BOSS FyreBox™
4. FireMastic-300™
5. Fire Rated Plasterboard Lining
6. Steel or Timber Stud Framing / Noggin
7. P40-MAK Wrap

Construction Details – BOSS Batt – Mid Wall Infill Panel in Framed Wall Systems – 60, 90 & 120min Requirements

The below details outline the use of the BOSS FyreBox™ installed into a Mid Mount BOSS Batt infill panel to achieve a 60, 90 & 120min FRL in framed walls.

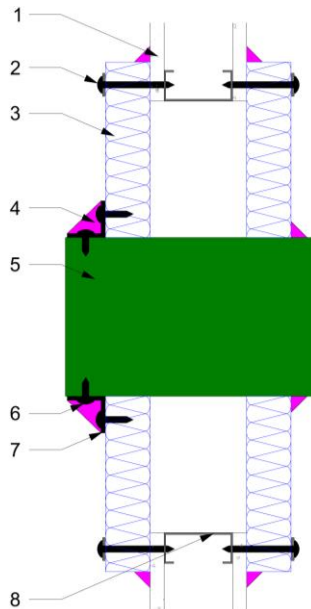

Section - Mid Mount – BOSS Batt Infill Panel 60, 90 & 120min FRL's

1. Framed Wall Systems
2. 90mm Pig Tail Screws with 20mm Diameter Washers
3. BOSS Batt
4. FireMastic-300™
5. BOSS FyreBox™
6. 8 x Pig Tail Screws
7. Steel Flange Bracket – Minimum 20mm x 20mm x 1mm thick).
8. Steel or Timber Stud Framing / Noggin

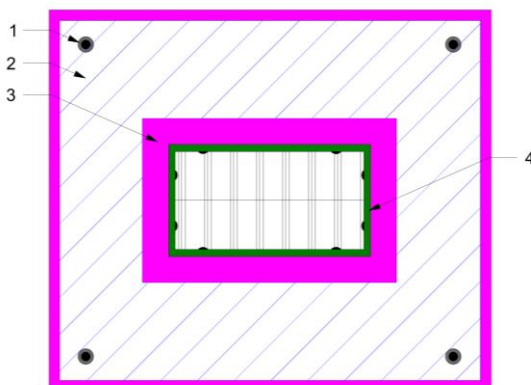

Elevation – Mid Mount - BOSS Batt Infill Panel 60, 90 & 120min FRL's

1. 90mm Pig Tail Screws with 20mm Diameter Washers
2. BOSS Batt
3. FireMastic-300™
4. BOSS FyreBox™

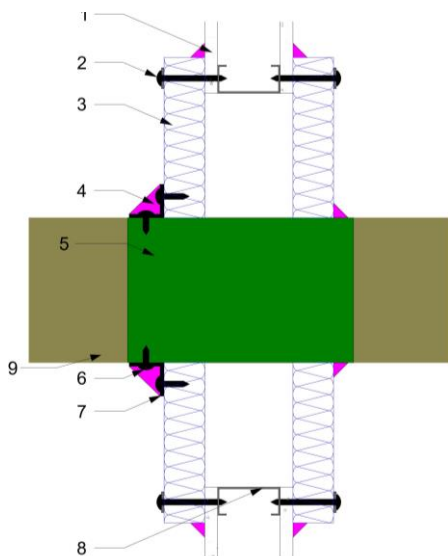

Section - Mid Mount – BOSS Batt Infill Panel 60, 90 & 120min FRL's with P40-MAK Wrap

1. Framed Wall Systems
2. 90mm Pig Tail Screws with 20mm Diameter Washers
3. BOSS Batt
4. FireMastic-300™
5. BOSS FyreBox™
6. 8 x Pig Tail Screws
7. Steel Flange Bracket – Minimum 20mm x 20mm x 1mm thick).
8. Steel or Timber Stud Framing / Noggin
9. P40-MAK Wrap

Installation – Other Walls – Rigid Walls / Modular Wall Systems

The below sequence outlines the steps to install a BOSS FyreBox™ within rigid wall systems and modular wall systems with an established Fire Resistance Level (FRL). Further construction details related to this method of installation and BOSS Batt infill panel can be found on pages 34 - 39.

For illustrative purposes the next sequence shows Speedpanel walls however this would apply to:

- | | |
|-----------------|------------------------------------|
| a. Speedpanel | f. Concrete |
| b. Korok | g. Solid & Hollow Masonry / Blocks |
| c. Pronto Panel | h. Dintel |
| d. Supa Panel | i. AFS |
| e. AAC / Hebel | j. AlphaPanel |

NOTE: The wall thickness must be a minimum of 100mm thick. Where the wall thickness is less than 100mm, it must be increased by a locally applied lining of fire rated plasterboard or BOSS Batts. The locally applied lining must surround the BOSS FyreBox™ by a minimum distance of 100mm. (3 sides only in a soffit mount application). The below installation sequence shows a build-up of 2 x 13mm layers of Fire Rated Plasterboard on a 78mm Speedpanel wall.

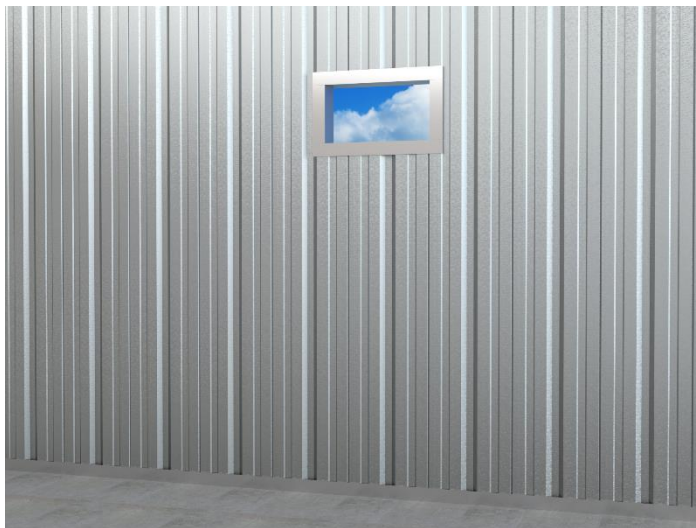

1. Cut the appropriate size aperture in the wall to suit the BOSS FyreBox™ ensuring a maximum 20mm annular gap.

Consult the technical manual or installation instructions of the wall provider for any requirements on how to treat wall openings, such as trimming or C-Track sections to surround the aperture.



2. Mark the position of the wall onto side of the FyreBox™. The mark shown in red in the image on the left is where the supporting flange bracket will be positioned.

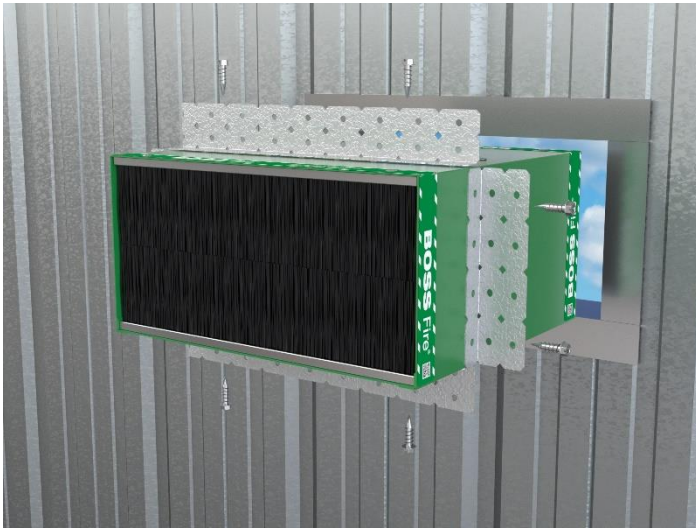

- Fit the flange bracket (minimum 20mm x 20mm x 1mm thick steel angle) to perimeter of the FyreBox™ using minimum 8g x 16mm self-drilling screws.

Fixings to be at maximum 200mm centres around the perimeter of the FyreBox™, minimum 2 fixings per side.



- Fit the FyreBox™ to opening within the wall and attached flange bracket to the wall face. Refer to wall manufacturer for screw type appropriate for wall system, ensuring fixings are all-steel. This bracket only required on one side of the wall.

Fixings to be at maximum 200mm centres around the perimeter of the FyreBox™, minimum 2 fixings per side.

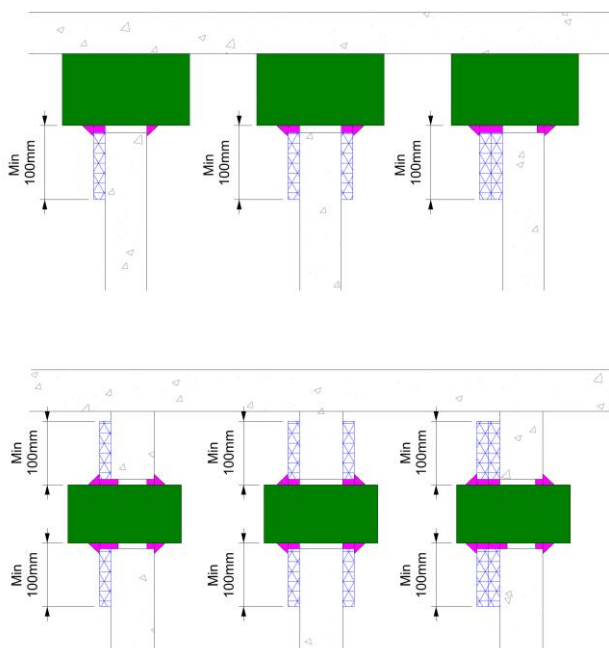

- Fit localised thickening to the wall substrate if less than 100mm thick using Fire Rated Plasterboard or BOSS Batt. Localised thickening or pattress must overlap the aperture by minimum 100mm. If fitting to the head of wall / soffit, the localised thickening must be fitted to 3 sides - both sides and base of the FyreBox™.

If fitted in a mid-wall scenario, the localised thickening must be fitted to four sides around perimeter of FyreBox™. For illustrative purposes the 78mm thick Speedpanel wall has had 2 x layers of 13mm fire rated plasterboard fitted around the aperture. Ensure plasterboard / Batt is screw fixed & edges sealed in accordance with the manufacturer's instructions.



6. Apply **BOSS FireMastic-300™** to perimeter around the FyreBox™ on both sides of the wall where it interfaces with the wall. Maximum 20mm wide annular gap x depth of plasterboard lining or 26mm deep.
7. The **BOSS FireMastic-300™** must then be finished with a 15 x 15mm fillet around the perimeter of the FyreBox™. (Localised thickening must also have perimeter edge sealed).

For a neat finish you can optionally measure and mark the size of the fillet by temporarily applying masking tape to the wall & FyreBox™ to control the size of the fillet and provide a neat finish for aesthetic purposes. Masking tape to be removed once sealant applied.

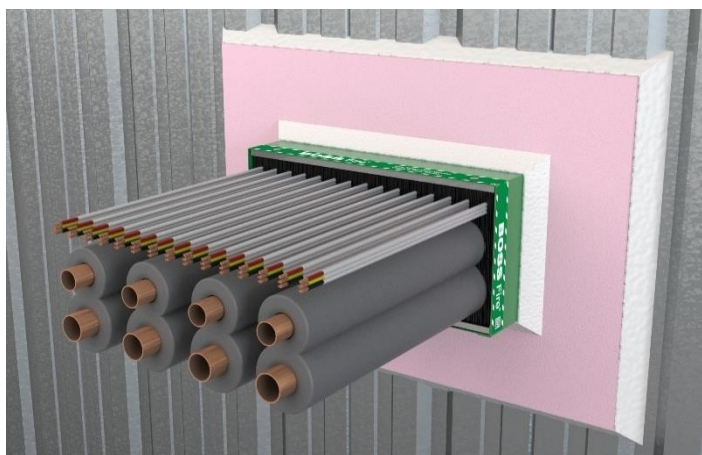

8. Approved Services can begin to be installed through the FyreBox™ after the FyreBox™ has been fixed into place ensuring that the services are Approved Services and system is in accordance with Tables 2, 3 or 4 on pages 10, 11 or 12.

(The FyreBox™ must not be overfilled to a point where the metal chassis bends, flexes, or bows from overfilling. The internal Intumescent Sachets & BrushSeals™ must not be removed or damaged. For FyreBoxes larger than a BFB-150 minimum fill rates apply when installing unwrapped systems. Refer to Minimum Fill Rates on page 16).

Note: All services must be supported independently both sides of the BOSS FyreBox™ to ensure no weight is transferred from services to the FyreBox™.

The use of the **P40-MAK Wrap** (300mm wide thermal wrap) may or may not be required dependant on services passing through the FyreBox™ and FRL required. For more information refer to Tables 2, 3 & 4 on pages 10, 11 & 12.

If **P40-MAK Wrap** is required, follow these additional steps:

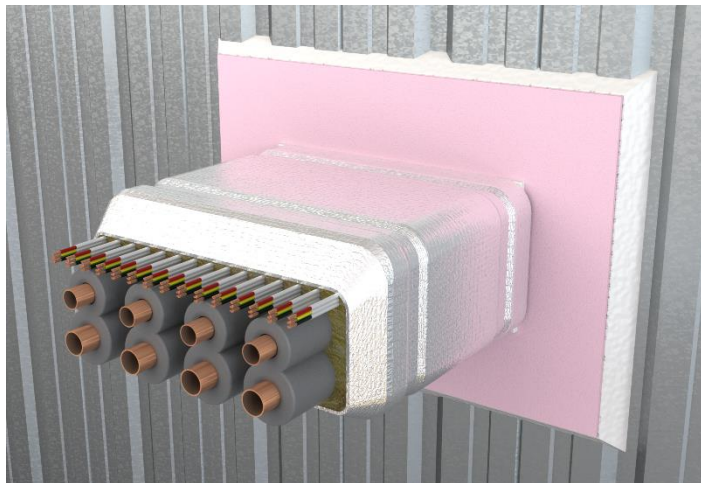

9. The use of the **P40-MAK Wrap** will provide an increased FRL in the form of higher insulation values up to 120 minutes. Fit **P40-MAK Wrap** (300mm wide) thermal wrap to both sides of the wall.

To apply the **BOSS P40 MAK-Wrap**:

- a) Place the **P40-MAK Wrap** on the services and wrap all the way around the bundled services, overlapping the previous layer by 90 degrees and use aluminium foil tape to hold the end of the wrap in place prior to ties being fitted.
- b) Use steel cable ties to tightly secure the wrap to the services. Use a minimum of 2 ties nominally 50mm in from each end of the wrap.
- c) Lastly, use aluminium foil tape to cover exposed mineral fibres between the foil backing and the services at the open ends of the wrap for a neat aesthetic finish.
- d) Repeat process on other side of the wall.

Note: In accordance with clause 4.9.3 of AS4072.1-2005 separating services can be fitted in a modular form in the approved construction element with minimum 40mm separation, unless tested otherwise. Therefore, mixed services can be bundled within the BOSS FyreBox™ however 40mm separation must be maintained from other external services, or additional BOSS FyreBoxes and of course the configuration must be in accordance with Tables 2, 3 or 4 on pages 10, 11 or 12.

Note that AS5601 Gas Installations & AS3500 Plumbing & Drainage also calls for separation between some services and the requirements of these Standards must be followed if these services exist within your installation or configuration.

For more information, please refer to following construction details for clarity on above sequence installation or contact BOSS Fire® on 1300 502 677 or info@bossfire.com.au.

Construction Details – Other Walls – Rigid Walls / Modular Wall Systems

The below details are in addition to the preceding sequence steps for clarity of components and installation techniques.

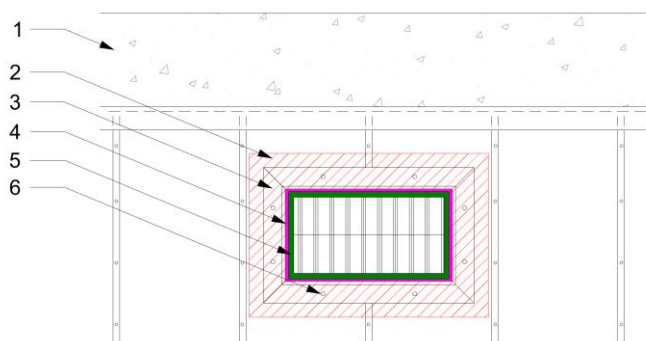

Other Walls Elevation.

1. Concrete Slab
2. Wall build up to min 100mm thickness:
 - a. Fire Rated Plasterboard. (EG: 2 x 13mm Layers to suit 78mm Speedpanel / Korok or 75mm AAC or Hebel). Or
 - b. BOSS Batt
3. Steel Flange Bracket – Minimum 20mm x 20mm x 1mm thick).
4. FireMastic-300™
5. BOSS FyreBox™
6. Screws to be maximum 200mm centres around perimeter of FyreBox™. Fixing type and size to be in accordance with wall manufacturers specifications.

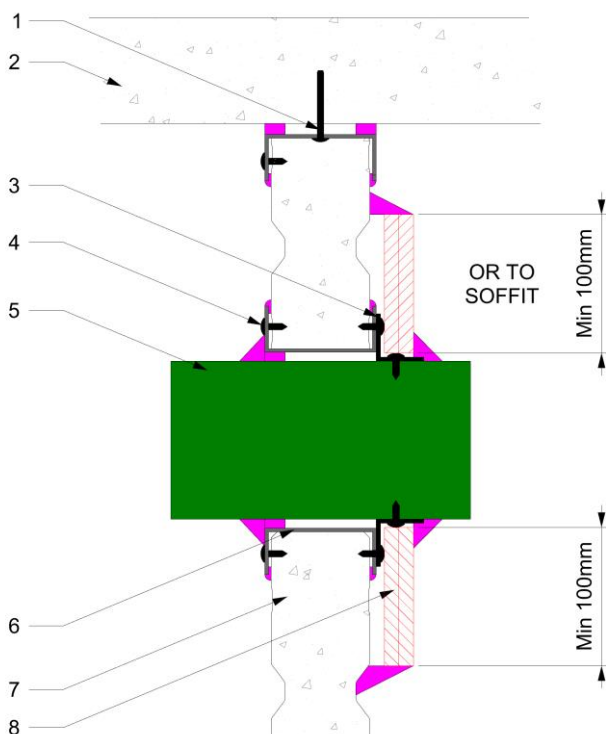

Other Walls Section.

1. Mechanical Fixing in accordance with wall manufacturers specifications.
2. Concrete Slab
3. Steel Flange Bracket – Minimum 20mm x 20mm x 1mm thick).
4. Screw fixing type in accordance with wall manufacturers specifications.
5. BOSS FyreBox™
6. C-Track in accordance with wall manufacturers specifications where applicable.
7. Wall Types:
 - a. Speedpanel / Korok (as shown).
 - b. Concrete
 - c. Solid & Hollow Masonry / Block
 - d. AAC / Hebel
 - e. AFS & Dintel
 - f. Pronto Panel & Supa Panel
 - g. AlphaPanel
8. Wall build up to minimum 100mm thickness:
 - a. Fire Rated Plasterboard. (EG: 2 x 13mm Layers to suit 78mm Speedpanel / Korok or 75mm AAC or Hebel).
 - b. BOSS Batt

The below details are in addition to the preceding sequence steps for clarity of components and installation techniques.

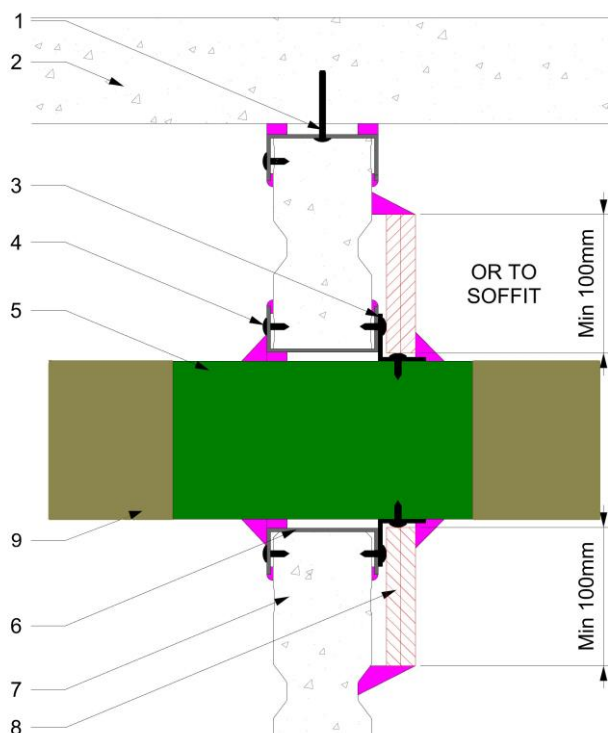

Other Walls Section with P40-MAK Wrap.

1. Mechanical Fixing in accordance with wall manufacturers specifications.
2. Concrete Slab
3. Steel Flange Bracket – Minimum 20mm x 20mm x 1mm thick).
4. Screw fixing type in accordance with wall manufacturers specifications.
5. BOSS FyreBox™
6. C-Track in accordance with wall manufacturers specifications where applicable.
7. Wall Types:
 - a. Speedpanel / Korok (as shown).
 - b. Concrete
 - c. Solid & Hollow Masonry / Block
 - d. AAC / Hebel
 - e. AFS & Dintel
 - f. Pronto Panel & Supa Panel
 - g. AlphaPanel
8. Wall build up to minimum 100mm thickness:
 - a. Fire Rated Plasterboard. (EG: 2 x 13mm Layers to suit 78mm Speedpanel / Korok or 75mm AAC or Hebel).
 - b. BOSS Batt

Construction Details – BOSS Batt – Head of Wall / Soffit Mount Infill Panel in Rigid Walls / Modular Wall Systems - 60min Requirements

The below details outline the use of the BOSS FyreBox™ installed into a Soffit Mount BOSS Batt infill panel to achieve a 60min FRL in rigid walls & modular wall systems.

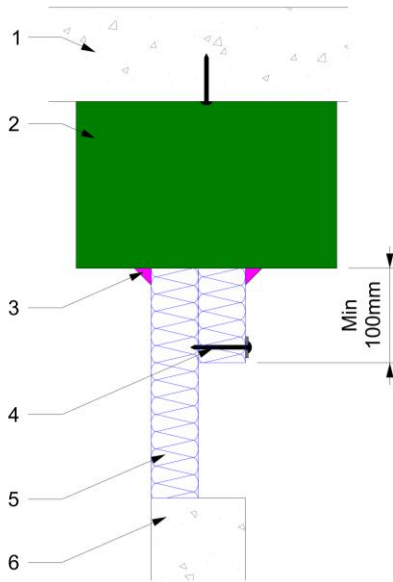

Sections – Soffit Mount - BOSS Batt Infill Panel 60min FRL with and without P40-MAK Wrap

1. Concrete Slab
2. BOSS FyreBox™
3. FireMastic-300™
4. 90mm Pig Tail Screws with 20mm Diameter Washers
5. BOSS Batt
6. Rigid Walls & Modular Wall Systems:
 - a. Concrete
 - b. Solid & Hollow Masonry / Block
 - c. AAC / Hebel
 - d. AFS & Dincel
 - e. Speedpanel & Korok
 - f. Pronto Panel & Supa Panel
7. P40-MAK Wrap

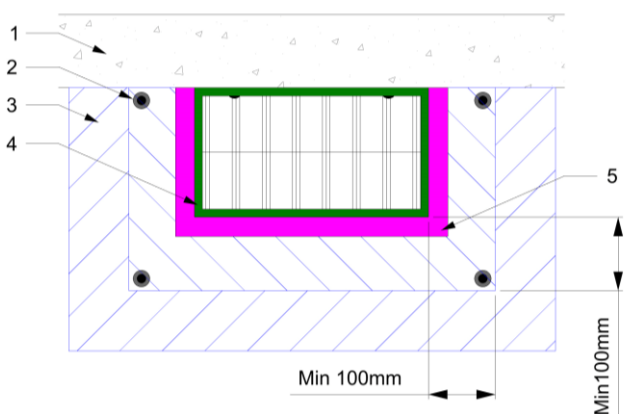
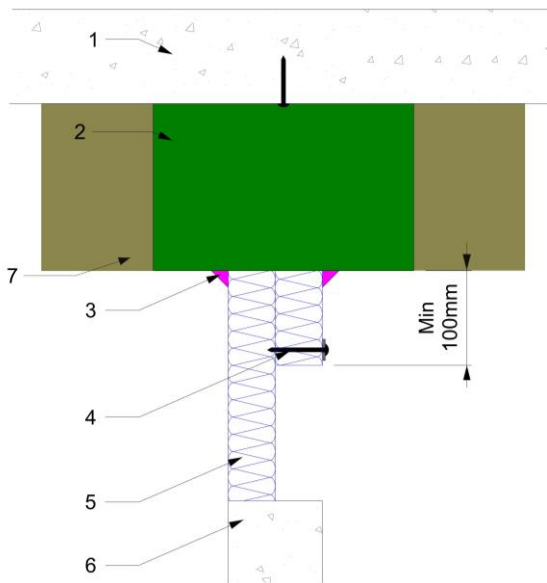

Elevation – Soffit Mount - BOSS Batt Infill Panel 60min FRL

1. Concrete Slab
2. 90mm Pig Tail Screws with 20mm Diameter Washers
3. BOSS Batt
4. BOSS FyreBox™
5. FireMastic-300™ perimeter seal.

Construction Details – BOSS Batt – Head of Wall / Soffit Mount Infill Panel in Rigid Walls / Modular Wall Systems – 90min & 120min Requirements

The below details outline the use of the BOSS FyreBox™ installed into a Soffit Mount BOSS Batt infill panel to achieve a 90min & 120min FRL's in rigid walls & modular wall systems.

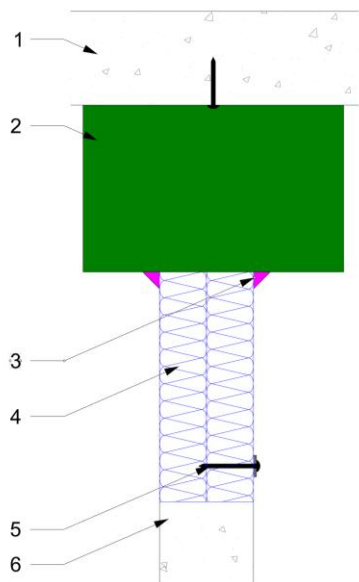

Section – Soffit Mount - BOSS Batt Infill Panel 90min & 120min FRL's with and without P40-MAK Wrap

1. Concrete Slab
2. BOSS FyreBox™
3. FireMastic-300™
4. BOSS Batt
5. 90mm Pig Tail Screws with 20mm Diameter Washers
6. Rigid Walls & Modular Wall Systems:
 - a. Concrete
 - b. Solid & Hollow Masonry / Block
 - c. AAC / Hebel
 - d. AFS & Dincel
 - e. Speedpanel & Korok
 - f. Pronto Panel & Supa Panel
7. P40-MAK Wrap

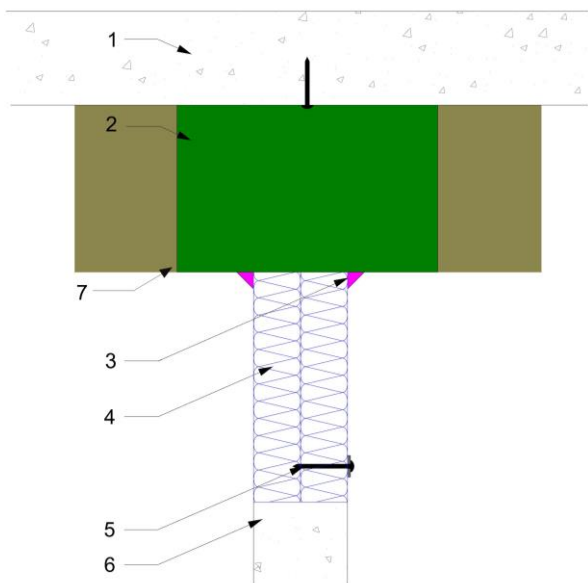

Elevation – Soffit Mount - BOSS Batt Infill Panel 90min & 120min FRL's

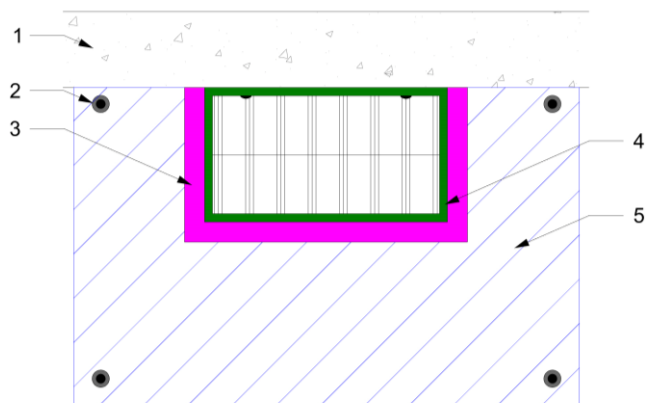

1. Concrete Slab
2. 90mm Pig Tail Screws with 20mm Diameter Washers
3. FireMastic-300™
4. BOSS FyreBox™
5. BOSS Batt

Construction Details – BOSS Batt – Mid Wall Infill Panel in Rigid Walls / Modular Wall Systems – 60min Requirements

The below details outline the use of the BOSS FyreBox™ installed into a Mid Mount BOSS Batt infill panel to achieve a 60min FRL in rigid walls & modular wall systems.

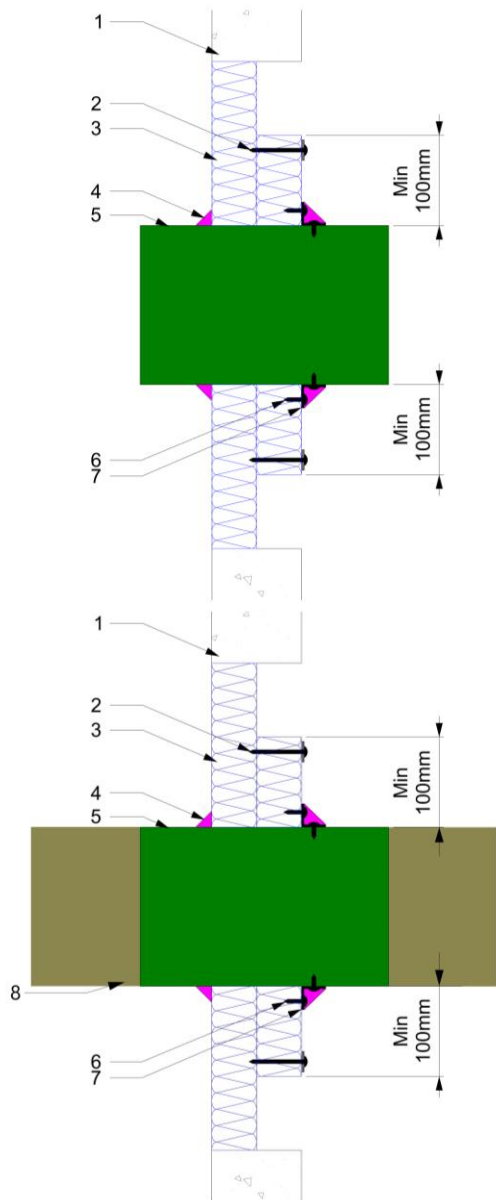

Section - Mid Mount – BOSS Batt Infill Panel 60min FRL

1. Rigid Walls & Modular Wall Systems:
 - a. Concrete
 - b. Solid & Hollow Masonry / Block
 - c. AAC / Hebel
 - d. AFS & Dincel
 - e. Speedpanel & Korok
 - f. Pronto Panel & Supa Panel
2. 90mm Pig Tail Screws with 20mm Washer
3. BOSS Batt
4. FireMastic-300™
5. BOSS FyreBox™
6. 8 x Pig Tail Screws
7. Steel Flange Bracket – Minimum 20mm x 20mm x 1mm thick).
8. P40-MAK Wrap

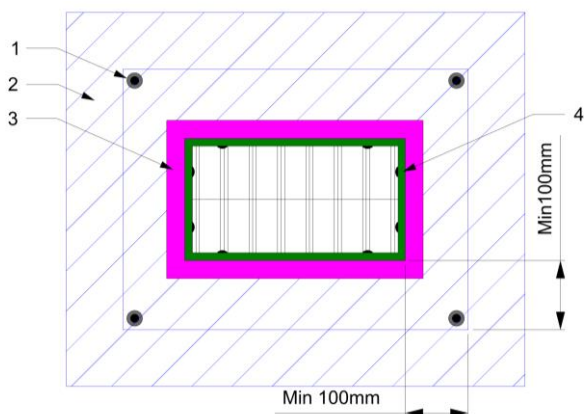

Elevation – Mid Mount - BOSS Batt Infill Panel 60min FRL

1. 90mm Pig Tail Screws with 20mm Washer
2. BOSS Batt
3. FireMastic-300™
4. BOSS FyreBox™

Construction Details – BOSS Batt – Mid Wall Infill Panel in Rigid Walls / Modular Wall Systems – 90min & 120min Requirements

The below details outline the use of the BOSS FyreBox™ installed into a Mid Mount BOSS Batt infill panel to achieve a 90min & 120min FRL's in rigid walls & modular wall systems.

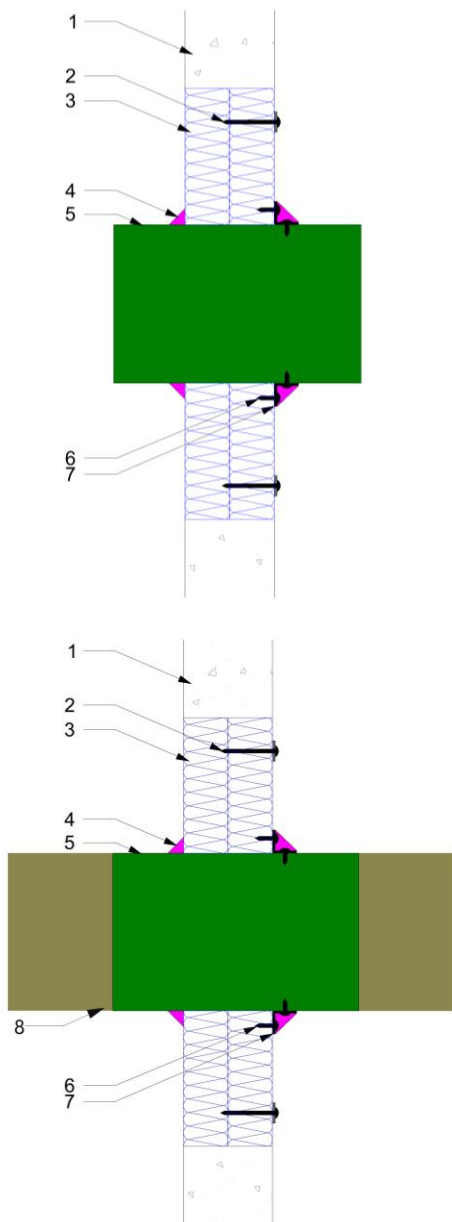

Section - Mid Mount – BOSS Batt Infill Panel 90min & 120min FRL's

1. Rigid Walls & Modular Wall Systems:
 - a. Concrete
 - b. Solid & Hollow Masonry / Block
 - c. AAC / Hebel
 - d. AFS & Dincel
 - e. Speedpanel & Korok
 - f. Pronto Panel & Supa Panel
2. 90mm Pig Tail Screws with 20mm Washer
3. BOSS Batt
4. FireMastic-300™
5. BOSS FyreBox™
6. 8 x Pig Tail Screws
7. Steel Flange Bracket – Minimum 20mm x 20mm x 1mm thick).
8. P40-MAK Wrap

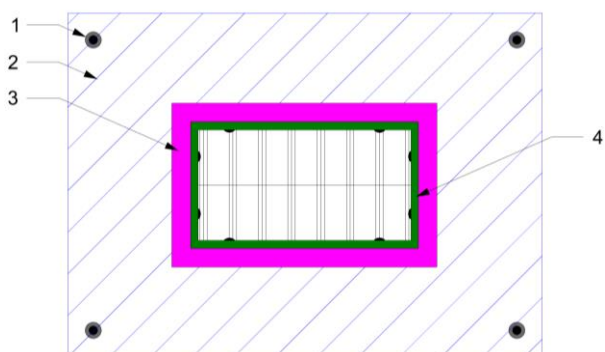

Elevation – Mid Mount - BOSS Batt Infill Panel 90 & 120min FRL's

1. 90mm Pig Tail Screws with 20mm Washer
2. BOSS Batt
3. FireMastic-300™
4. BOSS FyreBox™

Installation – Concrete Floor Slabs – Retro Fit

The below sequence outlines the steps to install a BOSS FyreBox™ into a concrete floor slab with an established Fire Resistance Level (FRL). Further construction details related to this method of installation can be found on page 43.

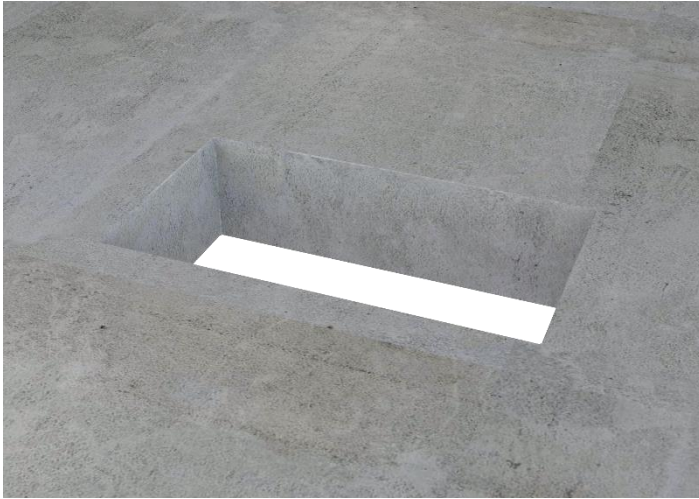

1. Ensure opening is pre-formed in concrete floor slab ensuring a maximum 10mm annular gap around the FyreBox™.

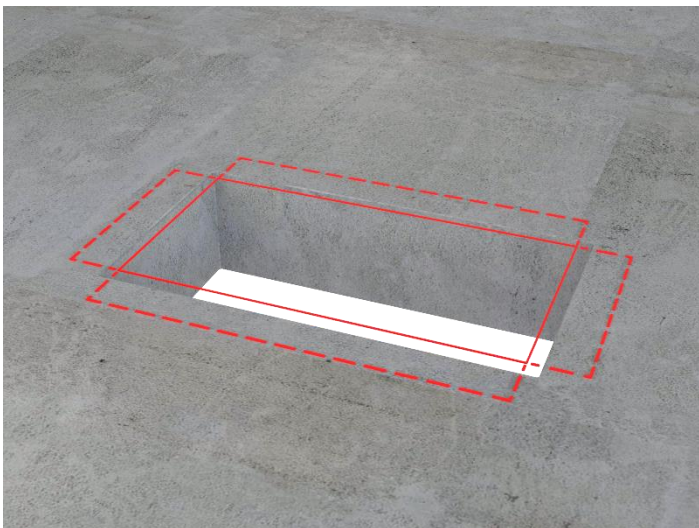

2. Mark the proposed position of the top surface of concrete slab onto side of the FyreBox™, ensuring the FyreBox™ will protrude through top of slab approximately 30mm. The mark shown in the image of the left is where the supporting flange bracket will be positioned.

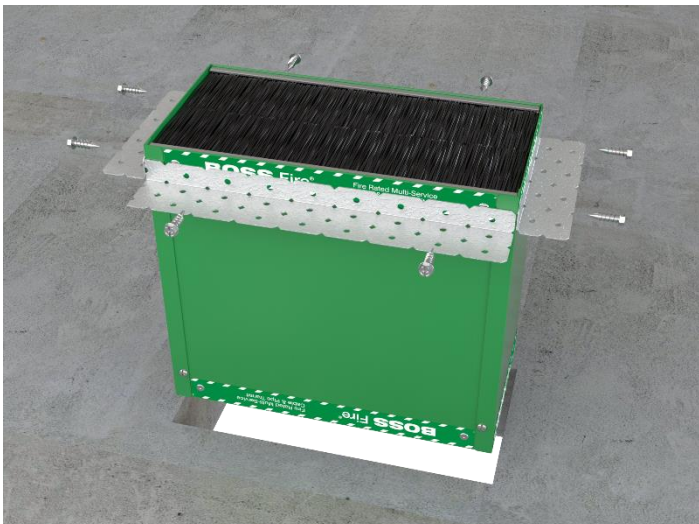

3. Using minimum 20mm x 40mm x 1mm steel angle, fit the flange bracket with the 20mm side of angle to FyreBox™ using 8g x 16mm self-drilling screws. The 40mm face of the bracket is to fit to the concrete slab.

Fixings to be at maximum 200mm centres around the perimeter of the FyreBox™, minimum 2 fixings per side.



4. Lower the FyreBox™ into the aperture, fixing the flange bracket into the concrete using minimum 8 x M8 x 40mm all-steel masonry anchors.

Fixings to be at maximum 200mm centres around the perimeter of the FyreBox™, minimum 2 fixings per side.

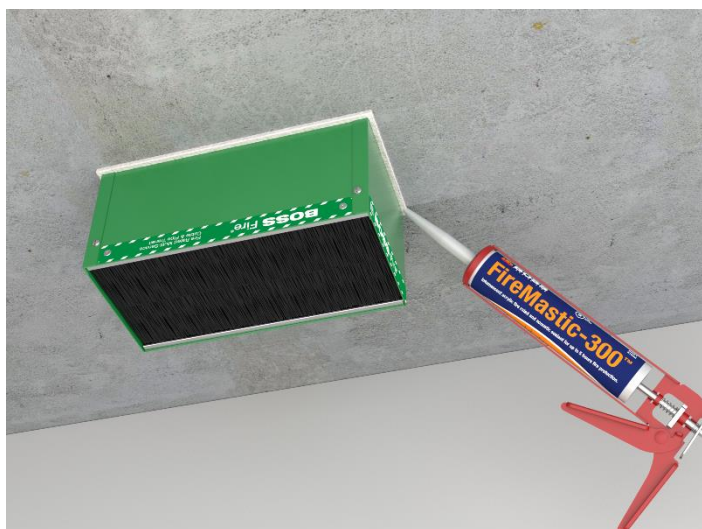

5. Under the slab: Apply **BOSS FireMastic-300™** sealant to perimeter gap on underside of concrete slab. Maximum 10mm wide annular gap by nominal 25mm depth.

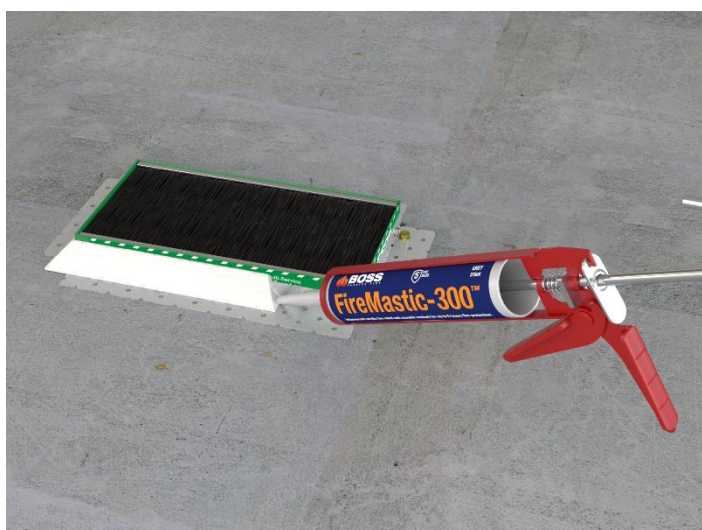

6. On top of the slab: Apply minimum 20mm x 20mm fillet of **BOSS FireMastic-300™** sealant to perimeter of the FyreBox™ over the top of the flange bracket.

For a neat aesthetic finish you can optionally measure and mark the size of the fillet by temporarily applying masking tape to the concrete slab & FyreBox™ to control the size of the fillet and avoid unsightly spreading of the sealant. Masking tape to be removed once sealant applied.



7. Approved Services can begin to be installed through the FyreBox™ after the FyreBox™ has been fixed into place ensuring that the services are Approved Services and system is in accordance with Tables 5, 6 or 7 on pages 13, 14 or 15.

(The FyreBox™ must not remain empty nor be overfilled to a point where the metal chassis bends, flexes, or bows from overfilling. The internal Intumescent Sachets & BrushSeals™ must not be removed or damaged).

Note: All services must be supported independently both sides of the BOSS FyreBox™ to ensure no weight is transferred from services to the FyreBox™.



8. The use of the **P40-MAK Wrap** will provide an increased FRL in the form of higher insulation values up to 120 minutes. Fit **P40 MAK-Wrap** (300mm wide) thermal wrap to the top side of the slab.

Apply the **BOSS P40 MAK-Wrap**:

- a) Place the **P40-MAK Wrap** on the services and wrap all the way around the bundled services, and any exposed BOSS FyreBox™, overlapping the previous layer by 90 degrees and use aluminium foil tape to hold the end of the wrap in place prior to ties being fitted.
- b) Use either metal tie wire (minimum 1mm diameter) or steel cable ties to tightly secure the wrap to the services. Use a minimum of 2 ties nominally 50mm in from each end of the wrap.
- c) Lastly, use aluminium foil tape to cover exposed mineral fibres between the foil backing and the services at the open ends of the wrap for a neat aesthetic finish.
- d) Only required on top side of slab.

Note: In accordance with clause 4.9.3 of AS4072.1-2005 separating services can be fitted in a modular form in the approved construction element with minimum 40mm separation, unless tested otherwise. Therefore, mixed services can be bundled within the BOSS FyreBox™ however 40mm separation must be maintained from other external services, or additional BOSS FyreBoxes and of course the configuration must be in accordance with Tables 5, 6 or 7 on pages 13, 14 or 15.

Note that AS5601 Gas Installations & AS3500 Plumbing & Drainage also calls for separation between some services and the requirements of these Standards must be followed if these services exist within your installation or configuration.

For more information, please refer to following construction details for clarity on above sequence installation or contact BOSS Fire® on 1300 502 677 or info@bossfire.com.au.

Construction Details – Concrete Floor Slabs – Retro Fit

The below details are in addition to the preceding sequence steps for clarity of components and installation techniques.

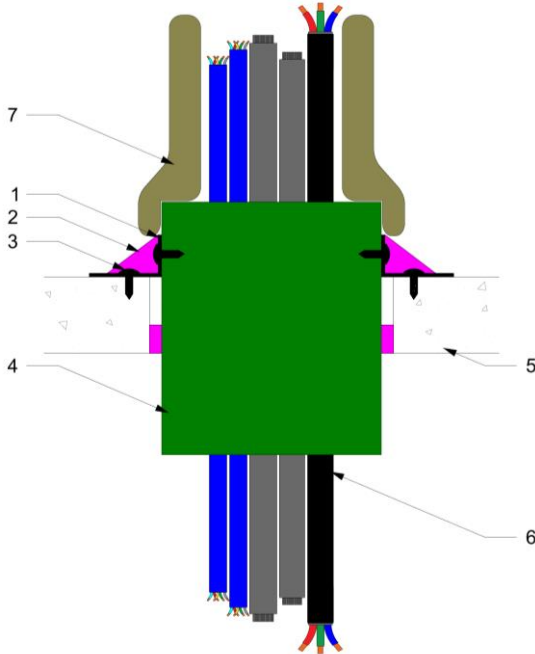

Floor Slab – Retrofit – Section With P40-MAK Wrap

1. 20mm x 40mm x 1mm Thick Steel Angle
2. FireMastic-300™ - Minimum 20mm x 20mm Fillet to Top Side of Slab and 10mm Wide x 25mm Depth to underside of slab.
3. M8 x 40mm all-steel masonry anchors.
4. BOSS FyreBox™
5. Concrete Floor Slab
6. Services in accordance with Tables 5, 6 or 7 on pages 13, 14 or 15.
7. P40-MAK Wrap to cover any exposed BOSS FyreBox™ and wrap services, ensure overlapping of the previous layer by 90 degrees.

Installation – Fire Rated Ceiling / Floor Systems

The below sequence outlines the steps to install a BOSS FyreBox™ into a ceiling / floor system with an established Fire Resistance Level (FRL). Further construction details related to this method of installation can be found on page 47.



1. When mounting into a framed ceiling/floor system, make sure the system is framed correctly with bearers and or joists within 20mm of the FyreBox™ on all four sides. Consult the technical manual or installation instructions of the provider of the ceiling / floor system for full details.

NOTE: Image to the left shows framing of timber bearers on a ceiling / floor system prior to plasterboard Installation.

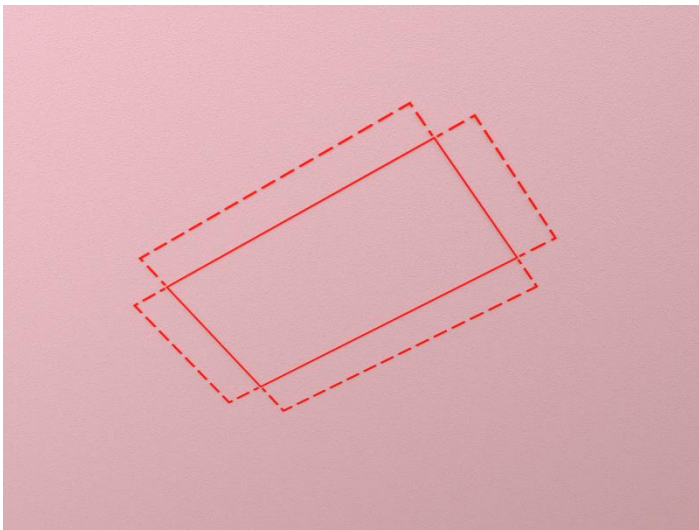

2. Mark the proposed position of ceiling profile on the side of the FyreBox™ ensuring the FyreBox™ will protrude through the underside of the ceiling 15mm. The mark on the image to the left is where the supporting flange bracket will be positioned.



3. Cut out plasterboard ready for the BOSS FyreBox™.

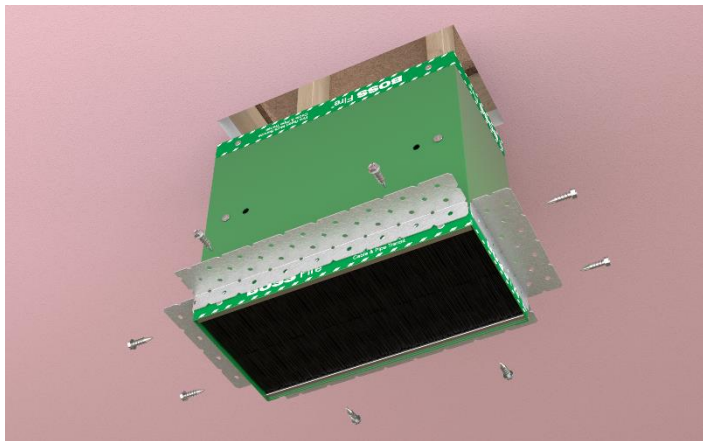

- Using minimum 20mm x 40mm x 1mm angle for the flange bracket, fit 20mm side of flange bracket to the end of the FyreBox™ using minimum 8g x 12mm all-steel screws.

Fixings to be at maximum 200mm centres around the perimeter of the FyreBox™, minimum 2 fixings per side.

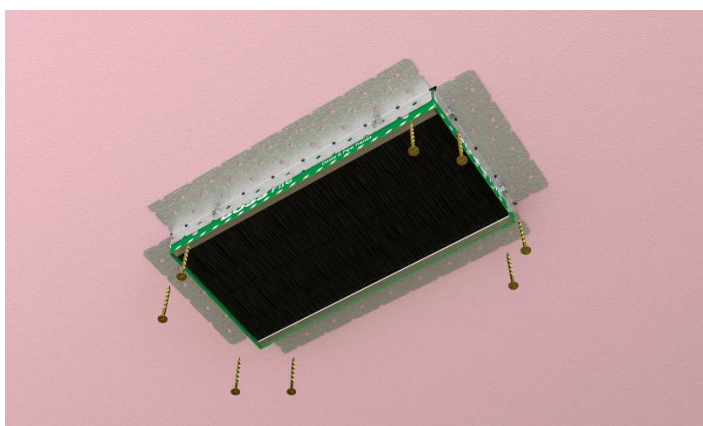

- Fix the FyreBox™ into ceiling aperture, fixing the angle using approved all-steel plasterboard / timber screws in accordance with ceiling / floor system manufacturers instructions.

Fixings to be at maximum 200mm centres around the perimeter of the FyreBox™, minimum 2 fixings per side.



- Apply **BOSS FireMastic-300™** sealant to the interface between the FyreBox™ and plasterboard and the FyreBox™ and the flooring on the upper and lower face providing a flush finish. Maximum 10mm wide annular gap x depth of linings.

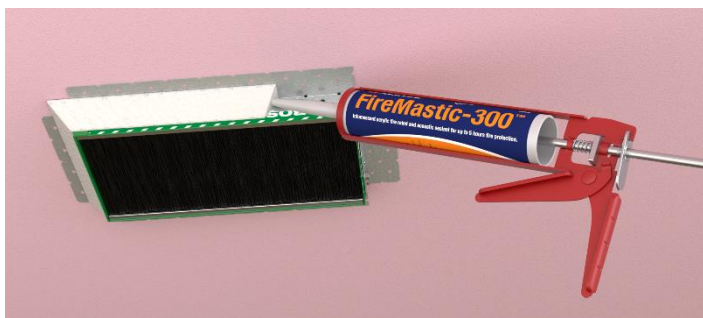

- Apply minimum 20mm x 25mm fillet of **BOSS FireMastic-300™** sealant to perimeter of FyreBox™ over the top of angle mount on ceiling side.

For a neat aesthetic finish you can optionally measure and mark the size of the fillet by temporarily applying masking tape to the ceiling & FyreBox™ to control the size of the fillet and avoid unsightly spreading of the sealant. Masking tape to be removed once sealant applied.



9. Approved Services can begin to be installed through the FyreBox™ after the FyreBox™ has been fixed into place ensuring that the services are Approved Services and system is in accordance with Tables 5, 6 or 7 on pages 13, 14 or 15.

(The FyreBox™ must not remain empty nor be overfilled to a point where the metal chassis bends, flexes, or bows from overfilling. The internal Intumescent Sachets & BrushSeals™ must not be removed or damaged).

Note: All services must be supported independently both sides of the BOSS FyreBox™ to ensure no weight is transferred from services to the FyreBox™.



8. The use of the **P40-MAK Wrap** will provide an increased FRL in the form of higher insulation values up to 120 minutes. Fit **P40 MAK-Wrap** (300mm wide) thermal wrap to the top side of ceiling / floor system.

Apply the **BOSS P40 MAK-Wrap**:

- a) Place the **P40-MAK Wrap** on the services and wrap all the way around the bundled services and any exposed BOSS FyreBox™, overlapping the previous layer by 90 degrees and use aluminium foil tape to hold the end of the wrap in place prior to ties being fitted.
- b) Use either metal tie wire (minimum 1mm diameter) or steel cable ties to tightly secure the wrap to the services. Use a minimum of 2 ties nominally 50mm in from each end of the wrap.
- c) Lastly, use aluminium foil tape to cover exposed mineral fibres between the foil backing and the services at the open ends of the wrap for a neat aesthetic finish.
- d) Only required on top side of ceiling/floor system.

Note: In accordance with clause 4.9.3 of AS4072.1-2005 separating services can be fitted in a modular form in the approved construction element with minimum 40mm separation, unless tested otherwise. Therefore, mixed services can be bundled within the BOSS FyreBox™ however 40mm separation must be maintained from other external services, or additional BOSS FyreBoxes and of course the configuration must be in accordance with Tables 5, 6 or 7 on pages 13, 14 or 15.

Note that AS5601 Gas Installations & AS3500 Plumbing & Drainage also calls for separation between some services and the requirements of these Standards must be followed if these services exist within your installation or configuration.

For more information, please refer to following construction details for clarity on above sequence installation or contact BOSS Fire® on 1300 502 677 or info@bossfire.com.au.

Construction Details – Fire Rated Ceiling / Floor Systems

The below details are in addition to the preceding sequence steps for clarity of components and installation techniques.

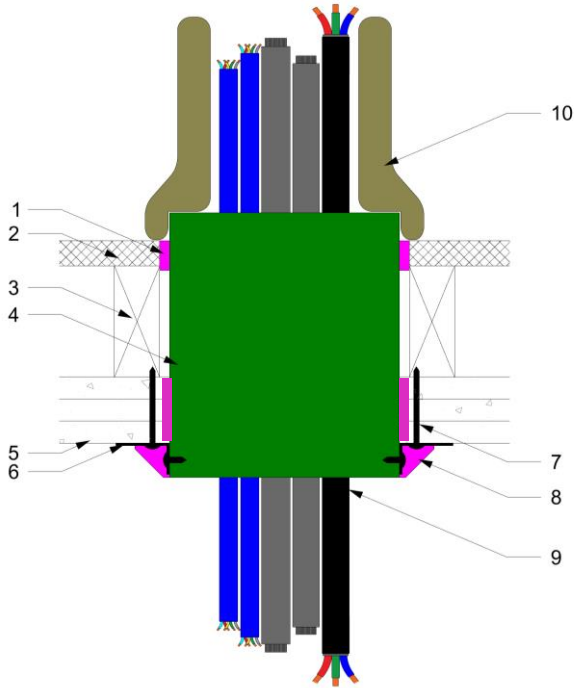

Fire Rated Ceiling / Floor System

With P40-MAK Wrap.

1. FireMastic-300™ - 10mm Wide x 19mm Depth
Topside flush finish.
2. 19mm Particleboard Flooring.
3. Timber Framing for floor system.
4. BOSS FyreBox™
5. Fire Rated Plasterboard
6. Steel 20mm x 40mm x 1mm Thick Steel Angle to
perimeter of FyreBox™.
7. Screw fixing type in accordance with wall
manufacturers specifications.
8. FireMastic-300™ - Minimum 20mm x 25mm Fillet
to Ceiling Side.
9. Services in accordance with refer to Tables 5, 6
or 7 on pages 13, 14 or 15.
10. P40-MAK Wrap to cover any exposed BOSS
FyreBox™ and wrap services, ensure overlapping
of the previous layer by 90 degrees.

Glossary of Terms

For the purposes of this Technical Guide the below definitions can be used when referencing certain terminology:

Approved Applications – applications in which the BOSS FyreBox™ is configured as outlined in Branz FC12925 Issue 7. Which is based on a variety of testing in accordance with AS1530.4: 2014 and then assessed in accordance with AS4072.1-2005.

Approved Services – refers to services such as pipes & cables pursuant to Branz FC12925 Issue 7.

Approved Element – refers to the building elements in which the BOSS FyreBox™ can be installed into pursuant to Branz FC12925 Issue 7.

FRL – Abbreviation for 'Fire Resistance Level'. When shown as a performance outcome for the BOSS FyreBox™ will be in the form of - / x / x , "x" being shown as a number representing the amount of minutes certified to AS1530.4:2014 and / or AS4072.1-2005.

Performance Solution – (as defined by the National Construction Code 2019 – Volume 1 Amendment 1) means a method of complying with the Performance Requirements other than by a Deemed-to-Satisfy Solution.

Performance Requirement - (as defined by the National Construction Code 2019 – Volume 1 Amendment 1) means a requirement which states the level of performance which a Performance Solution or Deemed-to-Satisfy Solution must meet.

OD – Abbreviation for 'Outside Diameter'.

Framed Wall Systems – Refers to steel or timber fire rated framed wall systems lined with fire rated plasterboard pursuant to Branz FC12925 Issue 7 including fire rated plasterboard walls, Shaftliner / Shaftwall, Partiwall / Party systems, IntRwall & Barrierline.

Rigid Walls – Refers to rigid wall systems pursuant to Branz FC12925 Issue 7 including normal weight concrete walls & solid or hollow masonry walls, AFS & Dintel.

Modular Wall Systems – Refers to modular wall systems pursuant to Branz FC12925 Issue 7 including AAC, Hebel, Speedpanel, Korok, Supapanel & Pronto Panel.

Health and Safety

To learn more about the safe handling of BOSS FyreBox™, see the Safety Data Sheet available at bossfire.com.au

Limitation

BOSS Fire has provided the above technical information in good faith and to the best of its knowledge. This information was deemed to be correct at the time of publication. Should any data come to BOSS Fire's attention relating to the fire resistance or performance of the product described BOSS Passive Fire reserve the right to amend this document.

BOSS Fire strive to constantly improve and develop products so this information may change without notice.

The information contained herein has been developed as a guide only and it does not constitute a guarantee of compliance of all applications. Each project and/or application may have specific requirements and you must investigate these carefully. Ensure that you have read and understood the appropriate certification relative to your needs, and ensure you seek acceptance from the Certifying Authority or compliance inspector before installation. For updates on the range of BOSS Fire® certification please contact BOSS Technical Services. +61 2 9531 8591

Further Information

For additional technical information on the performance of BOSS FyreBox™, other BOSS Fire® products or any other BOSS Fire® related information please contact us on:

Phone	1300 502 677
NZ Phone	0800 502 677
Fax	1300 602 677
International	+612 9531 8591
Email	info@bossfire.com.au
Web	bossfire.com
Address	Unit 1, 16 Atkinson Rd Taren Point NSW 2229 AUSTRALIA