

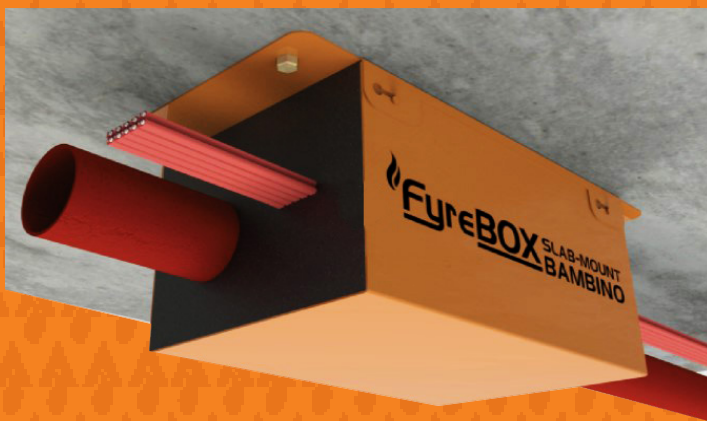

## ACTIVE WET & DRY FIRE

# FyreBOX

## Slab-Mount Bambino



The FyreBOX Slab Mount Bambino is a head of wall service penetration system specifically manufactured for individual trades to simplify passive fire by allowing installation of pipe and cable services before the wall construction, providing predictable site costs with the independence from other contractors schedules, and a reliable method of fire stopping.



### KEY FEATURES

- Sprinkler pipes penetrations can be installed before walls are constructed
- No need to install couplings on sprinkler pipes
- Suitable for both pipes and cables in the same penetration
- Tested with Firesense alarm and other cables
- Tested for steel and CPVC sprinklers
- Tested with multiple services with no separation required between
- Suitable for apartment entry, riser shaft and commercial wall penetrations
- Fully tested and compliant to AS1530.4-2014
- Training and support provided

### APPROVED SERVICES

Steel Pipes	Up to NB60
CPVC	Pipes up to 60mm
Firesense	Alarm cables
Power	Copper and Aluminum cores
Data/Comms	All cables
PVC	Drain pipes and conduits up to 32mm

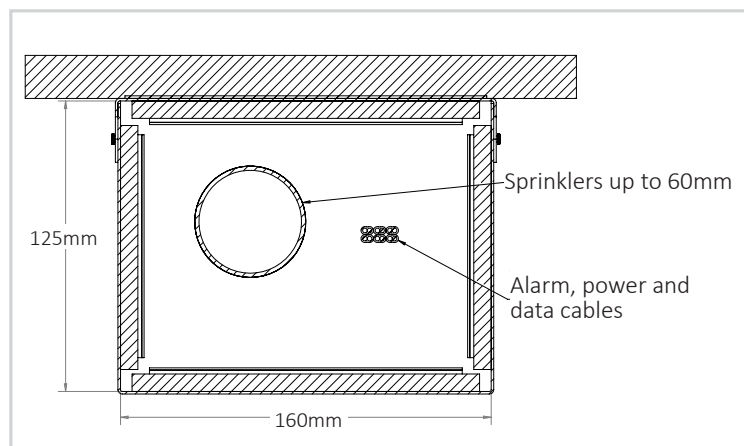

# TABLE OF CONTENTS



Section		Page
WHY FyreBOX for Active Fire Service Trades		4
FyreBOX Benefits- 30% Labour Savings		5
System Selector		6
Fire Resistance Level		7
FRL Tables	60 Minute Plasterboard Stud Walls: <b>WRAP FREE</b>	8
	60 Minute Walsc® AAC Panel: <b>WRAP FREE</b>	9
	60 Minute Concrete, Masonry and Permanent Formwork Walls: <b>WRAP FREE</b>	10
	60 Minute IntrWall & Other Party Wall Systems	11
	60 Minute XCEM Alpha Panel walls	12
	90 Minute Walsc® AAC Panel	13
	90 Minute Plasterboard Stud Walls	14
	90 Minute Laminated Plasterboard Shaft Walls	15
	90 Minute XCEM Alpha Panel Walls	16
	120 Minute Plasterboard Stud Walls	17
	120 Minute Concrete, Masonry and Permanent Formwork Walls	18
	120 Minute Walsc® AAC Panels	19
	Speedpanel® Walls	20
	Trafalgar COREX Shaft Walls	21
Maxilite Board Bulkheads & Oversized Penetrations	22	
Installation Manual	Stage 1: Slab-Mount the FyreBOX- All Walls	23
	Stage 2: Wall Installation- Plasterboard and COREX	24
	Stage 2: Wall Installation- Walsc® and Hebel AAC Panel Wall	25
	Stage 2: Wall Installation- AlphaPanel	26
	Stage 2: Wall Installation- Speedpanel®	27
	Stage 3: Foam Installation- All Walls	28
	Stage 4: Wrapping- All Walls	29

# TABLE OF CONTENTS



Section	Page	
Installation Manual	Installation Alternatives: Riser Shaft	30
	Installation Alternatives: Stepped slab, Wall junctions, oversized openings	31
	Installation Alternatives: FyreBOX Double Vertical	32
	Installation Alternatives: FyreBOX Double Horizontal	33
	Installation Alternatives: IntRWall/Party Walls	34
	Installation Checklist- Plasterboard	35
	Installation Checklist- Walsc® and Hebel AAC Panel Wall	36
System Range	37	
Compliance	38	
Technical Drawings	Installation Overview	39
	Plasterboard Framing Details	40
	Standard Plasterboard Walls	41
	Shaftliner Walls	42
	Hebel®/Walsc® and AAC Walls- Openings up to 400x170mm	43
	Hebel®/Walsc® and AAC Walls- Openings greater than 400x170mm	44
	SpeedPanel® Walls	45
	Concrete / Masonry Walls	46
	FyreBOARD™ Maxilite	47
	TWRAP™ - Services Wrap	48
	TWRAP™ - 3-Sided Wrap	49
	TWRAP™ - Stacked Vertical	50
	TWRAP™ - Services Horizontal	51
	Stepped Slab	52
	Wall Junctions	53
Oversized Openings	54	



# WHY FyreBOX for Active Fire Services

In residential and commercial constructions, the active fire trades are often the first on site to start running spinkler pipes and fire systems cables under the slab soffit, before the fire compartment walls have been erected. This results in additional work for the fire contractors who have to install pipe couplings on each side of the fire walls to remove sections of the pipes to allow the walls to be installed, and/or defects where services are left penetrating through the head tracks of the fire wall.

The innovative Trafalgar FyreBOX Slab Mount BAMBINO (lower right) addresses these issues by providing a small footprint penetration system that can be installed before the walls are erected, allowing for the fire pipes and cables to be roughed in, commissioned and charged without waiting for the wall contractors.

The FyreBOX systems are tested with all common active fire services for residential and commercial projects through one simple penetration system providing FRL's from -/60/60 (wrap free) to -/120/120. The FyreBOX systems have been tested located at the head track/deflection heads in FULL SCALE wall tests to confirm their suitability in these locations.

## BENEFITS

- Install sprinkler pipes/cables before the fire walls
- No need for wraps (in most walls)
- Charge, test and commission fire services quicker
- Less leak points in spinkler systems
- Reduced defects
- Predictable fire stopping costs
- NCC 2022 Ready
- Thoroughly fire tested to AS1530.4-2014
- Visible and reliable compliance
- Space saving - gives one penetration point per apartment
- Suitable for SOU and riser shaft penetrations
- Multi-service solution
- Maintains acoustic rating

## WITHOUT FYREBOX:



Traditional fire sealant penetration systems need the fire walls to be installed first, requiring extra couplings for pipes (above). Fire cables (below) cause defects when run through deflection heads.



## WITH FYREBOX BAMBINO:

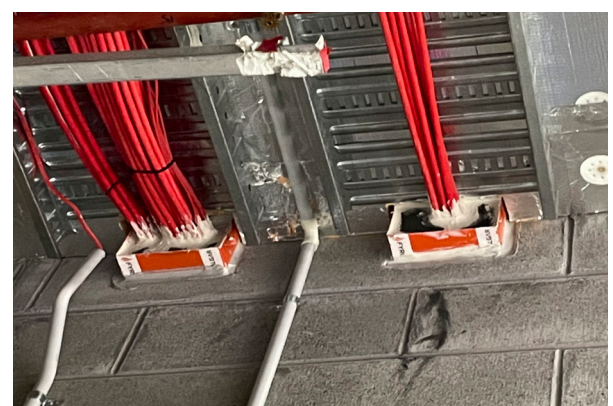



The FyreBOX Slab-Mount is a proudly Australian made passive fire penetration system used for multiple and mixed service penetrations which has been designed and tested to be built into residential/commercial apartment walls and riser shafts reducing the space required for service penetrations, providing predictable site costs and a reliable method of fire stopping.



*Passive Fire Protection from Trafalgar Fire a Brand you can Trust, with 75 years of Innovation.*



## TAKE BACK CONTROL OF YOUR PROJECT TIMEFRAMES

Re-think the sequencing of rough in, charging, leak testing and commissioning by pre-installing the penetration systems independently of other site trades.



 Benefits	Traditional sealant & wrap systems	FyreBOX BAMBINO
Penetration installed before the fire walls?	No	<b>Yes</b>
Services installed hard against slab soffit?	No	<b>Yes</b>
Multiple services in one penetration?	No	<b>Yes</b>
Separation between different services?	No	<b>Yes</b>
Allows for future services to be added?	No	<b>Yes</b>
Doesnt need large fillets of sealant for wrap free systems?	No	<b>Yes</b>
Other service trades can share the same penetration?	No	<b>Yes</b>
100's of cables in one penetration?	No	<b>Yes</b>

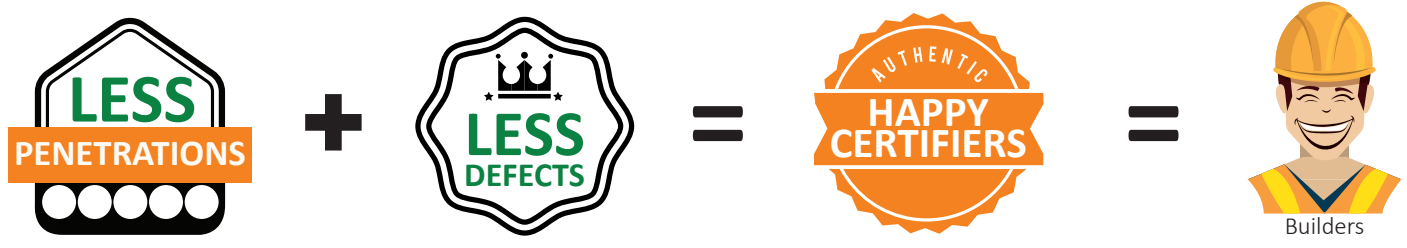

# FyreBOX SYSTEM SELECTOR

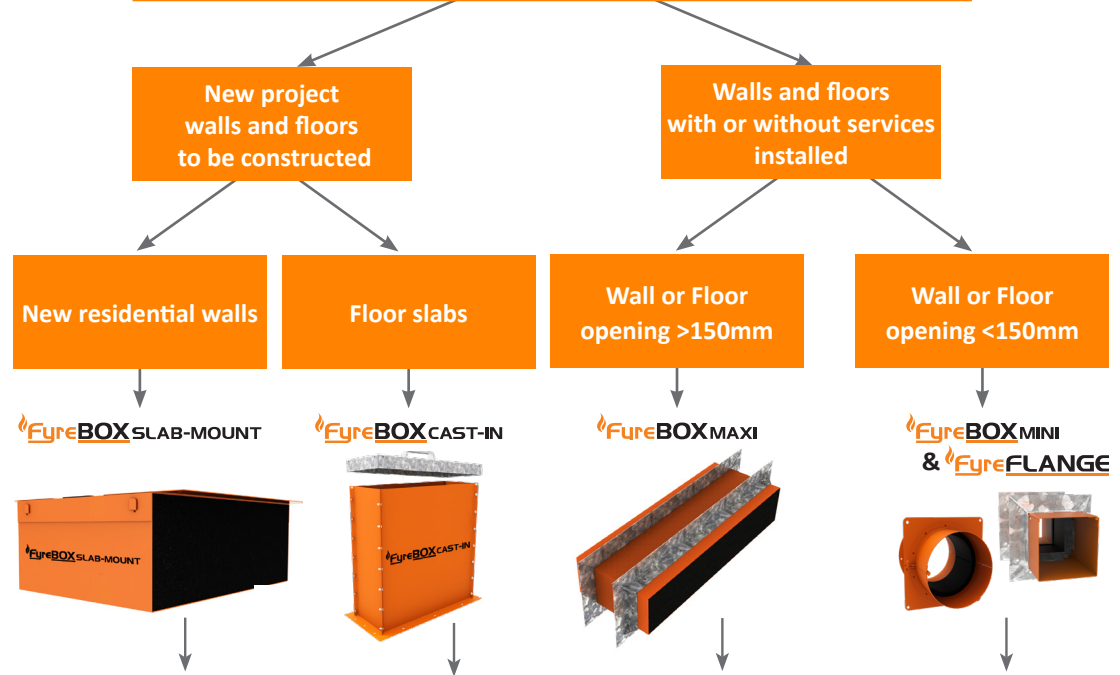

		FyreBOX SLAB-MOUNT	FyreBOX CAST-IN	FyreBOX MAXI	FyreBOX MINI & FyreFLANGE	
Installation Prior to Fire Barrier Construction		✓	✓	✗	✗	
Hole Cutting Required		✗	✗	✓	✓	
Fire Barrier	Floors	Concrete Slab	✗	✓	✓	
		FyreSET® Mortar	✗	✓	✗	✗
	Walls	Masonry Walls	✓	✗	✓	✓
		Concrete Walls	✓	✗	✓	✓
		Plasterboard	✓	✗	✓	✓
		Hebel® / Wasc®	✓	✗	✓	✓
		SpeedPanel®	✓	✗	✓	✓
		Alpha Panel®	✓	✗	✓	✓
		COREX walls	✓	✗	✓	✓
		FyreBOARD Maxilite™	✓	✗	✓	✓
	FyreBATT	✗	✗	✗	✓	
	Ceilings	Plasterboard Ceiling	✗	✗	✓	✓
		COREX ceilings	✗	✗	✓	✓
Services	Power Cables	✓	✓	✓	✓	
	Data Cables	✓	✓	✓	✓	
	Cable Trays	✓	✓	✓	✗	
	Steel and Copper Pipes	✓	✓	✓	✓	
	Aluminium Cables	✓	✓	✓	✓	
	CPVC Pipes	✓	✓	✓	✓	
	PVC Pipes	✗	✓	Floors Only	Floors Only	
	PEX	✓	✓	✓	✓	
	PEX-AL-PEX	✓	✓	✓	✓	
	Insulated Copper	✓	✓	✓	✓	
	Pair Coils	✓	✓	✓	✓	

For full FRL details please consult the relevant technical guide or contact Trafalgar Fire. Fire testing of Trafalgar Fire products is always ongoing.

# FIRE RESISTANCE LEVEL

## FIRE RATING – HOW IS FIRE PERFORMANCE MEASURED?

An FRL (fire resistance level) is a handy way of summarising the performance of a building element. It consists of 3 numbers, all given in minutes:

### FRL 120/120/120

(example)



#### Structural Adequacy

The ability of the building element to support the weight of adjacent building elements.

ie: a brick wall supporting a concrete floor slab above.



#### Integrity

The ability of an element to prevent the passage of flames and hot gasses.

ie: a plasterboard wall remaining intact and not allowing holes to form.

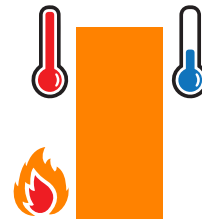

#### Insulation

The ability of an element to resist heat transfer from the exposed face to the unexposed face.

ie: a bundle of cables remaining below a set temperature limit on the unexposed side of the wall penetration system.

*Note: Penetrations are not required to have a Structural Adequacy rating and is usually expressed as a dash. For example, a penetration through a 2 hour load bearing wall would be written as -/120/120.*

## INTEGRITY

The FyreBOX Slab-Mount system will achieve the integrity performance for up to 2 hours physically stopping the direct spread of fire, however the insulation performance of the penetration will be limited to the type of wall being used and conductivity of the services in the penetration.

## INSULATION (TEMPERATURE RISE)

Heat transfer via conduction (or heat rise) will occur through the conductive parts of any penetration system. To limit the heat rise through the FyreBOX Slab-Mount penetration systems, our 25mm thick TWRAP™ foil encased blanket can be wrapped around the services and metal casing of the FyreBOX to achieve up to 2 hours of insulation performance. **There are some applications that won't require any TWRAP™ to achieve the full FRL, please refer to the tables below for specific details.**

## 60 Minute Plasterboard Stud Walls

### WRAP FREE

Minimum of 13mm fire grade plasterboard on each face of steel or timber stud, of minimum 64mm thickness with a stated FRL of -/60/60



**PATCH FREE!  
WRAP FREE!**

Service Type	Service Specification		FRL - WRAP FREE	
			64mm stud*	92mm studs
Plastic Pipes	PVC Pipes	Up to 32mm OD	-/60/30	-/60/60
	PEX Pipes	Up to 20mm	-/60/30	-/60/60
		Up to 32mm	-/60/30	-/60/60
		Up to 32mm with 19mm E-Flex insulation	-/60/30	-/60/60
	PEX-Al-PEX pipes	Up to 25mm	-/60/30	-/60/60
		Up to 32mm	-/60/-	-/60/-*
		Up to 32mm with 19mm E-Flex insulation	-/60/30	-/60/60
cPVC Pipes	Up to 40mm	-/60/-	-/60/-*	
	40mm to 60mm	-/60/30	-/60/60	
Bare Metal Pipes	Copper	Up to 50mm	-/60/-	-/60/-*
	Steel	up to 60mm	-/60/30	-/60/60
Metal Pipes Insulated**	Copper	Up to 50mm OD with PE insulation up to 20mm thick	-/60/30	-/60/30*
		Up to 50mm OD with FR insulation	-/60/30	-/60/60
		Up to 20mm OD with 38mm rockwool-type insulation	-/60/30	-/60/60
	Pair coil	Up to 9.5 & 19mm with 20mm FR insulation (or 13mm PE)	-/60/30	-/60/60
Power Cables - Copper Core	TPS	Up to 12x 2.5mm <sup>2</sup> per bundle	-/60/30	-/60/60
	Rigid or Flexible PVC Conduits	Up to 32mm OD (with any size power or comms cables up to 32mm diameter)	-/60/30	-/60/60
	AS1530.4 Appendix D1 cable set	Applies to copper core power cables and cable trays up to 1000mm wide	-/60/30	-/60/30*
Power Cables - Aluminium Core	Single Core cables	Bundles of up to 3 x 240mm <sup>2</sup> , 4 x 120mm <sup>2</sup> and 9 x 70mm <sup>2</sup> per bundle (16x cables total)	-/60/30	-/60/30*
Communications Cables	RG6 coax	Up to 3x per bundle	-/60/30	-/60/60
	AS1530.4 Appendix D2 cable set	Applies to copper core comms cables, including cable trays up to 1000mm wide	-/60/30	-/60/60
Conduits	Rigid or Flexible PVC Conduits	Up to 32mm OD (with any size power or comms cables up to 32mm diameter)	-/60/30	-/60/60

\*TWrap required on these specific services to achieve -/60/60 FRL. Refer to FC10266 for details in specific wall types.

\*\*With or without heat trace cable.

## 60 Minute AAC Panels WRAP FREE

Hebel, Wasc or other AAC panels 75mm thick when used for -/60/60 applications. **Note: 30mm Maxilite board can be laminated on one side of the penetration to increase the insulation performance without the need for TWrap as shown below (WRAP FREE).**



Service Type	Service Specification		FRL - WRAP FREE
			+ 30mm Maxilite
Plastic Pipes	PVC Pipe	Up to 32mm OD	-/60/60
	PEX Pipes	Up to 20mm	-/60/60
		Up to 32mm	-/60/60
		Up to 32mm with 19mm E-Flex insulation	-/60/60
	PEX-Al-PEX pipes	Up to 25mm	-/60/60
		Up to 32mm	-/60/-*
		Up to 32mm with 19mm E-Flex insulation	-/60/60
	cPVC Pipes	Up to 40mm	-/60/-*
		40mm to 60mm	-/60/60
	Bare Metal Pipes	Copper	Up to 50mm
Steel		up to 60mm	-/60/60
Metal Pipes Insulated**	Copper	Up to 50mm OD with PE insulation up to 20mm thick	-/60/60
		Up to 50mm OD with FR insulation	-/60/60
	Pair coil	Up to 20mm OD with 38mm rockwool-type insulation	-/60/60
		Up to 9.5 & 19mm with 13mm PE insulation	-/60/60
Power Cables - Copper Core	TPS	Up to 9.5 & 19mm with 20mm FR insulation	-/60/60
		Up to 12x 2.5mm <sup>2</sup> per bundle	-/60/60
	Rigid or Flexible PVC Conduits	Up to 32mm OD (with any size power or comms cables up to 32mm diameter)	-/60/60
Power Cables Aluminium Core	AS1530.4 Appendix D1 cable set	Applies to copper core power cables and cable trays up to 1000mm wide	-/60/30*
	Single Core cables	Bundles of up to 3 x 240mm <sup>2</sup> , 4 x 120mm <sup>2</sup> and 9 x 70mm <sup>2</sup> per bundle (16x cables total)	-/60/30*
Communications Cables	RG6 coax	Up to 3x per bundle	-/60/60
	AS1530.4 Appendix D2 cable set	Applies to copper core comms cables, including cable trays up to 1000mm wide	-/60/60
Conduits	Rigid or Flexible PVC Conduits	Up to 32mm OD (with any size power or comms cables up to 32mm diameter)	-/60/60

\*TWrap required on these specific services to achieve -/60/60 FRL. Refer to FC10266 for details in specific wall types.

\*\*With or without heat trace cable.



## 60 Minute Concrete, Masonry and Permanent Formwork Walls: Wrap Free

Walls designed as per AS3600 or AS3700 (or otherwise fire tested to achieved the required FRL with a minimum thickness as per the 90mm) including Dintel, AFS, Logically etc.

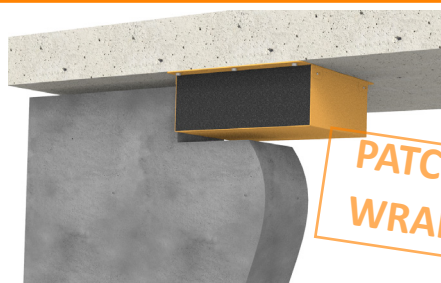

Service Type	Service Specification		FRL (Wrap Free)
Plastic Pipes	PVC Pipes	Up to 32mm OD	-/60/60
	PEX Pipes	Up to 20mm	-/60/60
		Up to 32mm	-/60/60
	PEX-Al-PEX pipes	Up to 20mm	-/60/60
		Up to 25mm	-/60/60
		Up to 32mm	-/60/-*
	cPVC Pipes	Up to 40mm	-/60/-*
40mm to 60mm		-/60/60	
Bare Metal Pipes	Copper	Up to 50mm	-/60/-*
	Steel	up to 60mm	-/60/60
Metal Pipes Insulated**	Copper	Up to 50mm OD with PE insulation up to 20mm thick	-/60/60
		Up to 50mm OD with FR insulation	-/60/60
		Up to 20mm OD with 38mm rockwool-type insulation	-/60/60
	Pair coil	Up to 9.5 & 19mm with 13mm FR insulation	-/60/60
		Up to 9.5 & 19mm with 20mm FR insulation	-/60/60
Power Cables - Copper Core	TPS	Up to 12x 2.5mm <sup>2</sup> per bundle	-/60/60
	Rigid or Flexible PVC Conduits	Up to 32mm OD (with any size power or comms cables up to 32mm diameter)	-/60/60
	AS1530.4 Appendix D1 cable set	Applies to copper core power cables and cable trays up to 1000mm wide	-/60/60
Power Cables Aluminium Core	Single Core cables	Bundles of up to 3 x 240mm <sup>2</sup> , 4 x 120mm <sup>2</sup> and 9 x 70mm <sup>2</sup> per bundle (16x cables total)	-/60/60
Communications Cables	RG6 coax	Up to 3x per bundle	-/60/60
	AS1530.4 Appendix D2 cable set	Applies to copper core comms cables, including cable trays up to 1000mm wide	-/60/60

\*TWrap required on these specific services to achieve -/60/60 FRL. Refer to FC10266 for details in specific wall types.

\*\*With or without heat trace cable.

## 60 minute IntrWall & Other Party Wall Systems

FyreBOX can penetrate the core of the wall, which is laminated with at least 1x16mm fire grade plasterboard on one side (or 1x layer of 13mm on both sides of the shaftliner core).

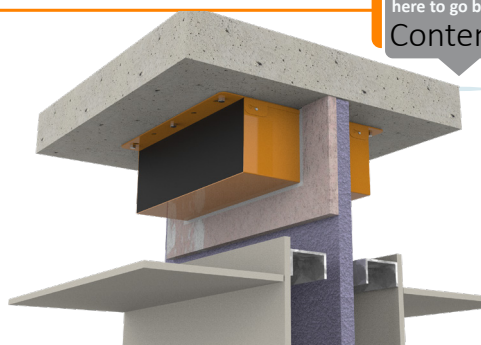

Service Type	Service Specification		FRL Wrap Free*	FRL with TWRAP™	TWrap Length required (mm)
Plastic Pipes	PVC Pipes	Up to 32mm OD	-/60/30	-/60/60	300
	PEX Pipes	Up to 20mm	-/60/30		300
		Up to 32mm	-/60/30		450
		Up to 32mm with 19mm E-Flex insulation	-/60/30		300
	PEX-Al-PEX pipes	Up to 25mm	-/60/30		300
		Up to 32mm	-/60/-		450
		Up to 32mm with 19mm E-Flex insulation	-/60/30		300
	cPVC Pipes	Up to 40mm	-/60/-		300
40mm to 60mm		-/60/30	300		
Bare Metal Pipes	Copper	Up to 50mm	-/60/-		300
	Steel	up to 60mm	-/60/30	300	
Metal Pipes Insulated**	Copper	Up to 50mm OD with PE insulation up to 20mm thick	-/60/30	300	
		Up to 50mm OD with FR insulation	-/60/30	300	
		Up to 20mm OD with 38mm rockwool-type insulation	-/60/30	300	
	Pair coil	Up to 9.5 & 19mm with 20mm FR insulation (or 13mm PE)	-/60/30	300	
Power Cables - Copper Core	TPS	Up to 12x 2.5mm <sup>2</sup> per bundle	-/60/30	300	
	AS1530.4 Appendix D1 cable set	Applies to copper core power cables and cable trays up to 1000mm wide	-/60/30	300	
Power Cables - Aluminium Core	Single Core cables	Bundles of up to 3 x 240mm <sup>2</sup> , 4 x 120mm <sup>2</sup> and 9 x 70mm <sup>2</sup> per bundle (16x cables total)	-/60/30	300	
Communications Cables	RG6 coax	Up to 3x per bundle	-/60/30	300	
	AS1530.4 Appendix D2 cable set	Applies to copper core comms cables, including cable trays up to 1000mm wide	-/60/30	300	
Conduits	Rigid or Flexible PVC Conduits	Up to 32mm OD (with or without cables)	-/60/30	300	

\*If using FyreBOX without TWrap for FRL's up to -/60/30, the wall must be thickened with 60mm Maxilite board 100mm strips on one side.

\*\*Heat trace cables may be installed underneath thermal lagging through a FyreBOX penetration

## 60 minute XCEM Alpha Panel walls

**Type 1** - 35mm Alpha Panel, framed with stud and lined on the other face with 13mm fire grade plasterboard (88mm minimum thickness)

**Type 2** - 35mm Alpha Panel, framed with stud on both sides, lined on both faces with 13mm fire grade plasterboard (200mm minimum thickness)

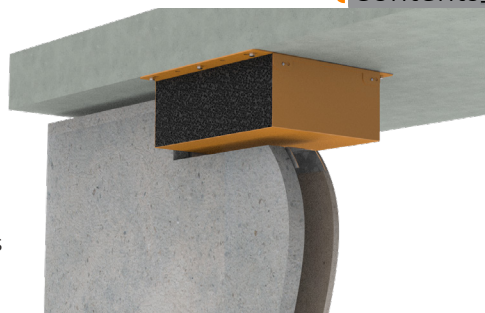

Service Type	Service Specification		FRL - WRAP FREE		FRL with TWRAP™	
			Type 1	Type 2	Both walls	Length required (mm)
Plastic Pipes	PVC Pipes	Up to 32mm OD	-/60/30	<b>-/60/60</b>	<b>-/60/60</b>	300
	PEX Pipes	Up to 20mm	-/60/30	<b>-/60/60</b>		300
		Up to 32mm	-/60/30	<b>-/60/60</b>		450
		Up to 32mm with 19mm E-Flex	-/60/30	<b>-/60/60</b>		300
		PEX-Al-PEX pipes	Up to 25mm	-/60/30		<b>-/60/60</b>
	Up to 32mm		-/60/-	-/60/-		450
	Up to 32mm with 19mm E-Flex		-/60/30	<b>-/60/60</b>		300
	cPVC Pipes	Up to 40mm	-/60/-	-/60/-		300
40mm to 60mm		-/60/30	<b>-/60/60</b>	300		
Bare Metal Pipes	Copper	Up to 50mm	-/60/-	-/60/-	300	
	Steel	up to 60mm	-/60/30	<b>-/60/60</b>	300	
Metal Pipes Insulated*	Copper	Up to 50mm OD with PE insulation up to 20mm thick	-/60/30	-/60/30	300	
		Up to 50mm OD with FR insulation	-/60/30	<b>-/60/60</b>	300	
		Up to 20mm OD with 38mm rockwool-type insulation	-/60/30	<b>-/60/60</b>	300	
	Pair coil	Up to 9.5 & 19mm with 20mm FR insulation (or 13mm PE)	-/60/30	<b>-/60/60</b>	300	
Power Cables - Copper Core	TPS	Up to 12x 2.5mm <sup>2</sup> per bundle	-/60/30	<b>-/60/60</b>	300	
	AS1530.4 Appendix D1 cable set	Applies to copper core power cables and cable trays up to 1000mm wide	-/60/30	-/60/30	300	
Power Cables Aluminium Core	Single Core cables	Bundles of up to 3 x 240mm <sup>2</sup> , 4 x 120mm <sup>2</sup> and 9 x 70mm <sup>2</sup> per bundle (16x cables total)	-/60/30	-/60/30	300	
Communications Cables	RG6 coax	Up to 3x per bundle	-/60/30	<b>-/60/60</b>	300	
	AS1530.4 Appendix D2 cable set	Applies to copper core comms cables, including cable trays up to 1000mm wide	-/60/30	<b>-/60/60</b>	300	
Conduits	Rigid or Flexible PVC Conduits	Up to 32mm OD (with or without cables)	-/60/30	<b>-/60/60</b>	300	

\*Heat trace cables may be installed underneath thermal lagging through a FyreBOX penetration

## 90 Minute AAC Panels

Hebel, Waslc or other AAC panels 75mm thick with a stated FRL up to -/90/90. Note if this wall is used for a -/60/60 apartment entry, please refer to page 9.

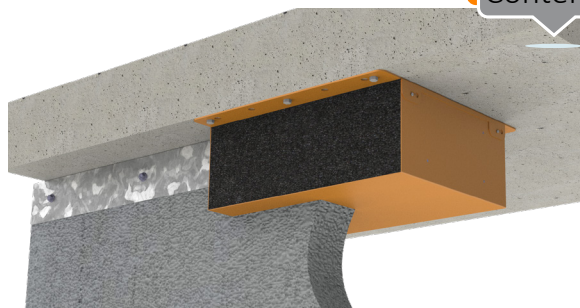

Service Type	Service Specification		FRL - WRAP FREE	FRL-With 300mm TWRAP
<b>Plastic Pipes</b>	PVC Pipes	Up to 32mm OD	-/90/30	-/90/90
	PEX Pipes	Up to 20mm	-/90/30	-/90/90
		Up to 32mm	-/90/30	-/90/90 <b>(450mm TWRap)</b>
		Up to 32mm with 19mm E-Flex insulation	-/90/30	-/90/90
	PEX-Al-PEX pipes	Up to 20mm	-/90/30	-/90/90
		Up to 25mm	-/90/30	-/90/90
		Up to 32mm	-/90/0	-/90/90 <b>(450mm TWRap)</b>
		Up to 32mm with 19mm E-Flex insulation	-/90/30	-/90/90
	cPVC Pipes	Up to 40mm	-/90/0	-/90/90
		40mm to 60mm	-/90/30	-/90/90
<b>Bare Metal Pipes</b>	Copper	Up to 50mm	-/90/0	-/90/90
	Steel	up to 60mm	-/90/30	-/90/90
<b>Metal Pipes Insulated*</b>	Copper	Up to 50mm OD with PE insulation up to 20mm thick	-/90/30	-/90/90
		Up to 50mm OD with FR insulation	-/90/30	-/90/90
		Up to 20mm OD with 38mm rockwool-type insulation	-/90/30	-/90/90
	Pair coil	Up to 9.5 & 19mm with 13mm PE insulation	-/90/30	-/90/90
		Up to 9.5 & 19mm with 20mm FR insulation	-/90/30	-/90/90
<b>Power Cables - Copper Core</b>	TPS	Up to 12x 2.5mm <sup>2</sup> per bundle	-/90/30	-/90/90
	AS1530.4 Appendix D1 cable set	Applies to copper core power cables and cable trays up to 1000mm wide	-/90/30	-/90/90
	Rigid or Flexible PVC Conduits	Up to 32mm OD (with any size power or comms cables up to 32mm diameter)	-/90/30	-/90/90
<b>Power Cables Aluminium Core</b>	Single Core cables	Bundles of up to 3 x 240mm <sup>2</sup> , 4 x 120mm <sup>2</sup> and 9 x 70mm <sup>2</sup> per bundle (16x cables total)	-/90/30	-/90/90
<b>Communications Cables</b>	RG6 coax	Up to 3x per bundle	-/90/30	-/90/90
	AS1530.4 Appendix D2 cable set	Applies to copper core comms cables, including cable trays up to 1000mm wide	-/90/30	-/90/90

\*With or without heat trace cable

## 90 Minute Plasterboard Stud Walls

Minimum of 16mm fire grade plasterboard on each face of a steel or timber stud of minimum 64mm thickness, with a stated FRL of -/90/90.



Service Type	Service Specification		FRL (Wrap Free)	FRL with TWRAP™	TWRAP™ Length required (mm)
Plastic Pipes	PVC Pipes	Up to 32mm OD	-/90/60	-/90/90	300
	PEX Pipes	Up to 20mm	-/90/60		300
		Up to 32mm	-/90/60		450
		Up to 32mm with 19mm E-Flex insulation	-/90/60		300
		Up to 25mm	-/90/60		300
	PEX-Al-PEX pipes	Up to 32mm	-/90/-		450
		Up to 32mm with 19mm E-Flex insulation	-/90/30		300
		cPVC Pipes	Up to 40mm		-/90/-
	40mm to 60mm		-/90/60		300
	Bare Metal Pipes	Copper	Up to 50mm		-/90/-
Steel		up to 60mm	-/90/30	300#	
Metal Pipes Insulated*	Copper	Up to 50mm OD with PE insulation up to 20mm thick	-/90/30	300	
		Up to 50mm OD with FR insulation	-/90/30	300	
		Up to 20mm OD with 38mm rockwool-type insulation	-/90/30	300	
	Pair coil	Up to 9.5 & 19mm with 20mm FR insulation (or 13mm PE)	-/90/30	300	
Power Cables - Copper Core	TPS	Up to 12x 2.5mm <sup>2</sup> per bundle	-/90/30	300	
	AS1530.4 Appendix D1 cable set	Applies to copper core power cables and cable trays up to 1000mm wide	-/90/30	300	
Power Cables Aluminium Core	Single Core cables	Bundles of up to 3 x 240mm <sup>2</sup> , 4 x 120mm <sup>2</sup> and 9 x 70mm <sup>2</sup> per bundle (16x cables total)	-/90/30	300	
Communications Cables	RG6 coax	Up to 3x per bundle	-/90/30	300	
	AS1530.4 Appendix D2 cable set	Applies to copper core comms cables, including cable trays up to 1000mm wide	-/90/30	300	
Conduits	Rigid or Flexible PVC Conduits	Up to 32mm OD (with or without cables)	-/90/60	300	

\*Heat trace cables may be installed underneath thermal lagging through a FyreBOX penetration  
 #With 300mm of loose TWRap infill packed around any cable tray services within the wrap.



## 90 Minute Laminated Plasterboard Shaft Walls

Minimum of 3x fire grade plasterboard on one side of a steel stud with a stated FRL of 90 or 120 minutes. FyreBOX penetration thickened with 60mm Maxilite in 100mm strips on one side of the penetration.

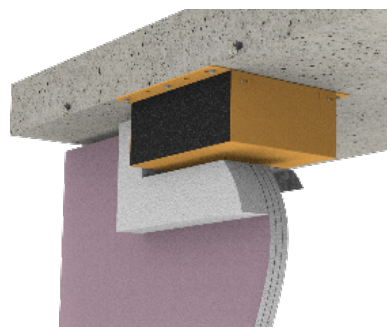

Service Type	Service Specification		Plasterboard outside minimum 64mm stud (FRL wrap Free)		FRL with TWRAP	TWRap Length required (mm)
			3x13mm plaster	3x16mm plaster		
Plastic Pipes	PVC Conduits	Up to 32mm OD	-/90/30	-/120/30	-/120/120 (Limited to the FRL of the wall)	300
	PEX Pipes	Up to 20mm	-/90/30	-/120/30		300
		Up to 32mm	-/90/30	-/120/30		450
		Up to 32mm with 19mm E-Flex insulation	-/90/30	Not approved		300 <b>(-/90/90 only)</b>
	PEX-Al-PEX pipes	Up to 25mm	-/90/30	-/120/30		450
		Up to 32mm	-/90/-	-/120/30		450
		Up to 32mm with 19mm E-Flex insulation	-/90/30	Not approved		300 <b>(-/90/90 only)</b>
	cPVC Pipes	Up to 40mm	-/90/-	-/120/-		300
40mm to 60mm		-/90/30	-/120/30	300		
Bare Metal Pipes	Copper	Up to 50mm	-/90/-	-/120/-	300	
	Steel	up to 60mm	-/90/30	-/120/30	300	
Metal Pipes Insulated**	Copper	Up to 50mm OD with PE insulation up to 20mm thick	-/90/30	-/120/30	300	
		Up to 50mm OD with FR insulation	-/90/30	-/120/30	300	
		Up to 20mm OD with 38mm rockwool-type insulation	-/90/30	-/120/30	300	
	Pair coil	Up to 9.5 & 19mm with 20mm FR insulation (or 13mm PE)	-/90/30	-/120/30	300	
Power Cables - Copper Core	TPS	Up to 12x 2.5mm <sup>2</sup> per bundle	-/90/30	-/120/30	300	
	AS1530.4 Appendix D1 cable set	Applies to copper core power cables and cable trays up to 1000mm wide	-/90/30	-/120/30	600**	
Power Cables Aluminium Core	Single Core cables	Bundles of up to 3 x 240mm <sup>2</sup> , 4 x 120mm <sup>2</sup> and 9 x 70mm <sup>2</sup> per bundle (16x cables total)	-/90/30	-/120/30	300	
Communications Cables	RG6 coax	Up to 3x per bundle	-/90/30	-/120/30	300	
	AS1530.4 Appendix D2 cable set	Applies to copper core comms cables, including cable trays up to 1000mm wide	-/90/30	-/120/30	450	
Conduits	Rigid or Flexible PVC Conduits	Up to 32mm OD (with or without cables)	-/90/30	-/120/30	300	

\*Heat trace cables may be installed underneath thermal lagging through a FyreBOX penetration

\*\*Loose TWRap infill installed onto cable trays for at least 300mm underneath TWRap

## 90 minute XCEM Alpha Panel walls

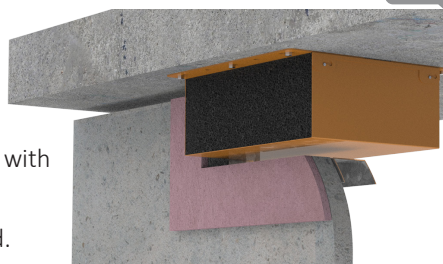

**Type 3** - 35mm Alpha Panel, framed with stud and lined on the other face with 16mm fire grade plasterboard (91mm minimum thickness).

**Type 4** - 35mm Alpha Panel laminated with 16mm fire grade plasterboard.

Service Type	Service Specification		FRL (Wrap Free)**		FRL with TWRAP™	
			Type 3	Type 4	Both walls	Length required (mm)
Plastic Pipes	PVC Conduits	Up to 32mm OD	-/90/60	-/90/30	-/90/90	450
	PEX Pipes	Up to 20mm	-/90/60	-/90/30		450
		Up to 32mm	-/90/60	-/90/30		450
		Up to 32mm with 19mm E-Flex	-/90/60	-/90/30		450
		Up to 25mm	-/90/60	-/90/30		450
	PEX-Al-PEX pipes	Up to 32mm	-/90/-	-/90/-		450
		Up to 32mm with 19mm E-Flex insulation	-/90/30	-/90/30		450
		cPVC Pipes	Up to 40mm	-/90/-		-/90/-
40mm to 60mm	-/90/60		-/90/30	450		
Bare Metal Pipes	Copper	Up to 50mm	-/90/-	-/90/30		450
	Steel	up to 60mm	-/90/30	-/90/30		450
Metal Pipes Insulated*	Copper	Up to 50mm OD with PE insulation up to 20mm thick	-/90/30	-/90/30		450
		Up to 50mm OD with FR insulation	-/90/30	-/90/30		450
		Up to 20mm OD with 38mm rockwool-type insulation	-/90/30	-/90/30		450
	Pair coil	Up to 9.5 & 19mm with 20mm FR insulation (or 13mm PE)	-/90/30	-/90/30		450
Power Cables - Copper Core	TPS	Up to 12x 2.5mm <sup>2</sup> per bundle	-/90/30	-/90/30		450
	AS1530.4 Appendix D1 cable set	Applies to copper core power cables and cable trays up to 1000mm wide	-/90/30	-/90/30	450	
Power Cables Aluminium Core	Single Core cables	Bundles of up to 3 x 240mm <sup>2</sup> , 4 x 120mm <sup>2</sup> and 9 x 70mm <sup>2</sup> per bundle (16x cables total)	-/90/30	-/90/30	450	
Communications Cables	RG6 coax	Up to 3x per bundle	-/90/30	-/90/30	450	
	AS1530.4 Appendix D2 cable set	Applies to copper core comms cables, including cable trays up to 1000mm wide	-/90/30	-/90/30	450	
Conduits	Rigid or Flexible PVC Conduits	Up to 32mm OD (with or without cables)	-/90/60	-/90/30	450	

\*Heat trace cables may be installed underneath thermal lagging through a FyreBOX penetration  
 \*\*Wrap free FRL's require a patch of 60mm Maxilite board 100mm strips on one side of the wall.

## 120 Minute Plasterboard Stud Walls

Minimum of 2x13mm fire grade plasterboard on each face of steel or timber stud, of minimum 64mm thickness with a stated FRL of -/120/120.



Service Type	Service Specification		FRL (Wrap Free)	FRL with TWRAP™ (all studs)	TWRAP™ Length required (mm)
<b>Plastic Pipes</b>	PVC Pipes	Up to 32mm OD	-/120/60	-/120/120	300
	PEX Pipes	Up to 20mm	-/120/60		300
		Up to 32mm	-/120/60		450
	PEX-Al-PEX pipes	Up to 20mm	-/120/60		300
		Up to 32mm	-/120/-		450
	cPVC Pipes	Up to 40mm	-/120/-		300
40mm to 60mm		-/120/60	300		
<b>Bare Metal Pipes</b>	Copper	Up to 50mm	-/120/-		300
	Steel	up to 60mm	-/120/60		300
<b>Metal Pipes Insulated*</b>	Copper	Up to 50mm OD with PE insulation up to 20mm thick	-/120/60		300
		Up to 50mm OD with FR insulation	-/120/60		300
		Up to 20mm OD with 38mm rockwool-type insulation	-/120/60		300
	Pair coil	Up to 9.5 & 19mm with 20mm FR insulation (or 13mm PE)	-/120/60	300	
<b>Power Cables - Copper Core</b>	TPS	Up to 12x 2.5mm <sup>2</sup> per bundle	-/120/60	300	
	AS1530.4 Appendix D1 cable set	Applies to copper core power cables and cable trays up to 1000mm wide	-/120/60	600**	
<b>Power Cables Aluminium Core</b>	Single Core cables	Bundles of up to 3 x 240mm <sup>2</sup> , 4 x 120mm <sup>2</sup> and 9 x 70mm <sup>2</sup> per bundle (16x cables total)	-/120/30	300	
<b>Communications Cables</b>	RG6 coax	Up to 3x per bundle	-/120/60	300	
	AS1530.4 Appendix D2 cable set	Applies to copper core comms cables, including cable trays up to 1000mm wide	-/120/60	450**	
<b>Conduits</b>	Rigid or Flexible PVC Conduits	Up to 32mm OD (with or without cables)	-/120/60	300	

\*Heat trace cables may be installed underneath thermal lagging through a FyreBOX penetration

\*\*Loose TWrap infill installed onto cable trays for at least 300mm underneath TWrap

## 120 Minute Concrete, Masonry and Permanent Formwork Walls

Walls designed as per AS3600 or AS3700 (or otherwise fire tested to achieved the required FRL with a minimum thickness as per the 90mm) including Dintel, AFS, Logcall etc.

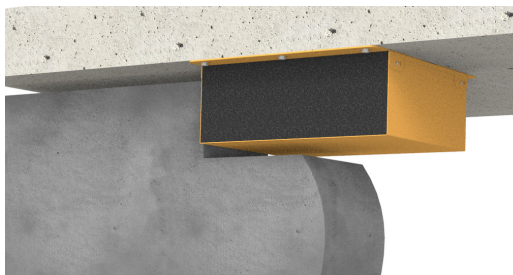

Service Type	Service Specification		FRL (Wrap Free)	FRL with TWRAP™ (all studs)	TWRAP™ Length required (mm)
Plastic Pipes	PVC Pipes	Up to 32mm OD	-/120/60	-/120/120	300
	PEX Pipes	Up to 20mm	-/120/60		300
		Up to 32mm	-/120/60		450
	PEX-Al-PEX pipes	Up to 20mm	-/120/60		300
		Up to 25mm	-/120/60		450
		Up to 32mm	-/120/0		450
	cPVC Pipes	Up to 40mm	-/120/0		300
		40mm to 60mm	-/120/60		300
Bare Metal Pipes	Copper	Up to 50mm	-/120/0	300	
	Steel	up to 60mm	-/120/60	300	
Metal Pipes Insulated*	Copper	Up to 50mm OD with PE insulation up to 20mm thick	-/120/60	300	
		Up to 50mm OD with FR insulation	-/120/60	300	
		Up to 20mm OD with 38mm rockwool-type insulation	-/120/60	300	
	Pair coil	Up to 9.5 & 19mm with 13mm FR insulation	-/120/60	300	
		Up to 9.5 & 19mm with 20mm FR insulation	-/120/60	300	
Power Cables - Copper Core	TPS	Up to 12x 2.5mm <sup>2</sup> per bundle	-/120/60	300	
	AS1530.4 Appendix D1 cable set	Applies to copper core power cables and cable trays up to 1000mm wide	-/120/60	600#	
Power Cables Aluminium Core	Single Core cables	Bundles of up to 3 x 240mm <sup>2</sup> , 4 x 120mm <sup>2</sup> and 9 x 70mm <sup>2</sup> per bundle (16x cables total)	-/120/30	300	
Communications Cables	RG6 coax	Up to 3x per bundle	-/120/60	300	
	AS1530.4 Appendix D2 cable set	Applies to copper core comms cables, including cable trays up to 1000mm wide	-/120/60	450#	
Conduits	Rigid or Flexible PVC Conduits	Up to 32mm OD (with or without cables)	-/120/60	300	

\*With or without heat trace cable.

#With 300mm of loose TWRap infill packed around any cable tray services within the wrap.

## 120 Minute AAC Panels

Hebel, Wasc or other AAC panels 75mm thick with a stated FRL up to -/120/120.

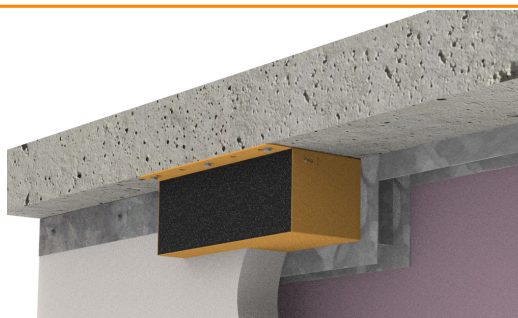

Service Type	Service Specification		FRL (Wrap Free)	FRL with TWRAP™	TWRAP™ Length required (mm)
Plastic Pipes	PVC pipes	Up to 32mm OD	-/120/30	-/120/120	300
	PEX Pipes	Up to 20mm	-/120/30		300
		Up to 32mm	-/120/30		450
	PEX-Al-PEX pipes	Up to 20mm	-/120/30		300
		Up to 25mm	-/120/30		450
		Up to 32mm	-/120/0		450
	cPVC Pipes	Up to 40mm	-/120/0		300
Up to 60mm		-/120/30	300		
Bare Metal Pipes	Copper	Up to 50mm	-/120/0		300
	Steel	up to 60mm	-/120/30		300
Metal Pipes Insulated*	Copper	Up to 50mm OD with PE insulation up to 20mm thick	-/120/30		300
		Up to 50mm OD with FR insulation	-/120/30		300
	Pair coil	Up to 20mm OD with 38mm rockwool-type insulation	-/120/30		300
		Up to 9.5 & 19mm with 13mm FR insulation	-/120/30		300
		Up to 9.5 & 19mm with 20mm FR insulation	-/120/30	300	
Power Cables - Copper Core	TPS	Up to 12x 2.5mm <sup>2</sup> per bundle	-/120/30	300	
	AS1530.4 Appendix D1 cable set	Applies to copper core power cables and cable trays up to 1000mm wide	-/120/30	600#	
Power Cables Aluminium Core	Single Core cables	Bundles of up to 3 x 240mm <sup>2</sup> , 4 x 120mm <sup>2</sup> and 9 x 70mm <sup>2</sup> per bundle (16x cables total)	-/120/30	300	
Communications Cables	RG6 coax	Up to 3x per bundle	-/120/30	300	
	AS1530.4 Appendix D2 cable set	Applies to copper core comms cables, including cable trays up to 1000mm wide	-/120/30	450#	
Conduits	Rigid or Flexible PVC Conduits	Up to 32mm OD (with or without cables)	-/120/60	300	

\*With or without heat trace cable

#With 300mm of loose TWRap infill packed around the services within the wrap.



## Speedpanel® Walls

Speedpanel walls of thickness ranging from 51mm (-/60/60), 64mm (-/90/90) and 78mm (-/120/120).

Note 51mm and 64mm Speedpanel walls required additional patch of 30mm Maxilite board on one side of the wall.

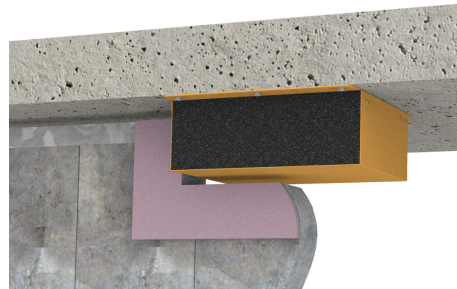

Service Type	Service Specification		51mm Speedpanel + 30mm Maxilite	64mm Speedpanel + 30mm Maxilite	78mm Speedpanel	TWrap Length required (mm)
Plastic Pipes	PVC pipes	Up to 32mm OD	-/60/60	-/90/90	-/120/120	300
	PEX Pipes	Up to 20mm				300
		Up to 32mm				450
		Up to 32mm with 19mm E-Flex**				450
		Up to 20mm				300
	PEX-AL-PEX pipes	Up to 32mm				450
		Up to 32mm with 19mm E-Flex**				450
		cPVC Pipes				Up to 40mm
Bare Metal Pipes	Copper	Up to 50mm				300
	Steel	up to 60mm				300
Metal Pipes Insulated#	Copper	Up to 50mm OD with PE insulation up to 20mm thick				300
		Up to 50mm OD with FR insulation				300
		Up to 20mm OD with 38mm rockwool-type insulation	-/60/60	-/90/90	-/120/120	300
	Pair coil	Up to 9.5 & 19mm with 13mm PE insulation				300
		Up to 9.5 & 19mm with 20mm FR insulation				300
Power Cables - Copper Core	TPS	Up to 12x 2.5mm <sup>2</sup> per bundle				300
	AS1530.4 Appendix D1 cable set	Applies to copper core power cables and cable trays up to 1000mm wide				600*
Power Cables Aluminium Core	Single Core cables	Bundles of up to 3 x 240mm <sup>2</sup> , 4 x 120mm <sup>2</sup> and 9 x 70mm <sup>2</sup> per bundle (16x cables total)				300
Communications Cables	RG6 coax	Up to 3x per bundle				300
	AS1530.4 Appendix D2 cable set	Applies to copper core comms cables, including cable trays up to 1000mm wide				450*
Conduits	Rigid or Flexible PVC Conduits	Up to 32mm OD (with or without cables)				300

\*300mm loose TWrap infill underneath TWrap

\*\* Maximum FRL-/90/90

#With or without heat trace cable

For specific service based FRL's without using TWrap, refer to report FC10266

## Trafalgar COREX Shaft Walls

2x laminated Corex boards fixed to one side of a 64mm steel stud. FRL of the wall is related to thickness of the Corex facings as shown in the table. [Click here for the Corex Shaft Wall technical Manual.](#)

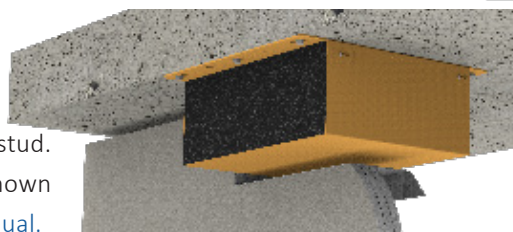

Service Type	Service Specification		Corex Board Specification & FyreBOX Penetration FRL*			TWrap Length required (mm)
			2x15mm	2x20mm	2x25mm	
Plastic Pipes	PVC Pipes	Up to 32mm OD	-/60/60	-/90/90	-/120/120	450
	PEX Pipes	Up to 20mm				450
		Up to 32mm				450
		Up to 32mm with 19mm E-Flex insulation				450
	PEX-Al-PEX pipes	Up to 20mm				450
		Up to 25mm				450
		Up to 32mm				450
		Up to 32mm with 19mm E-Flex insulation				450
	cPVC Pipes	Up to 40mm				450
		40mm to 60mm				450
Bare Metal Pipes	Copper	Up to 50mm				450
	Steel	up to 60mm				450
Metal Pipes Insulated**	Copper	Up to 50mm OD with PE insulation up to 20mm thick				450
		Up to 50mm OD with FR insulation				450
		Up to 20mm OD with 38mm rockwool-type insulation				450
	Pair coil	Up to 9.5 & 19mm with 13mm PE insulation				450
		Up to 9.5 & 19mm with 20mm FR insulation				450
Power Cables - Copper Core	TPS	Up to 12x 2.5mm <sup>2</sup> per bundle				450
	AS1530.4 Appendix D1 cable set	Applies to copper core power cables and cable trays up to 1000mm wide				450
Power Cables Aluminium Core	Single Core cables	Bundles of up to 3 x 240mm <sup>2</sup> , 4 x 120mm <sup>2</sup> and 9 x 70mm <sup>2</sup> per bundle (16x cables total)				450
Communications Cables	RG6 coax	Up to 3x per bundle				450
	AS1530.4 Appendix D2 cable set	Applies to copper core comms cables, including cable trays up to 1000mm wide				450
Conduits	Rigid or Flexible PVC Conduits	Up to 32mm OD (with or without cables)				450

For Corex walls, the wall must be thickened on one side with 100mm wide Maxilite, 60mm thick around the penetration.

\*For specific service based FRL's without using TWrap, refer to report FC10266.

\*\*Heat trace cables may be installed underneath thermal lagging through a FyreBOX penetration

## Maxilite Board Bulkheads and Oversized Penetrations

Maxilite FyreBOARD is commonly used to construct fire rated bulkheads or to seal oversized apertures cut into fire walls. Minimum thickness required 60mm. [Click here for the Maxilite technical manuals.](#)

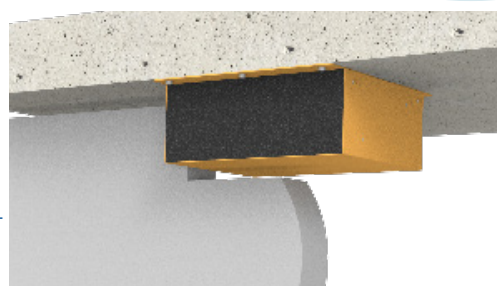

Service Type	Service Specification		FRL (Wrap Free)	FRL with TWRAP™ (all studs)	TWRAP™ Length required (mm)
Plastic Pipes	PVC Pipes	Up to 32mm OD	-/120/30	-/120/120	300
	PEX Pipes	Up to 20mm	-/120/30		300
		Up to 32mm	-/120/30		450
	PEX-Al-PEX pipes	Up to 20mm	-/120/30		300
		Up to 25mm	-/120/30		450
		Up to 32mm	-/120/0		450
	cPVC Pipes	Up to 40mm	-/120/0		300
40mm to 60mm		-/120/30	300		
Bare Metal Pipes	Copper	Up to 50mm	-/120/0		300
	Steel	up to 60mm	-/120/30		300
Metal Pipes Insulated*	Copper	Up to 50mm OD with PE insulation up to 20mm thick	-/120/30		300
		Up to 50mm OD with FR insulation	-/120/30		300
		Up to 20mm OD with 38mm rockwool-type insulation	-/120/30		300
	Pair coil	Up to 9.5 & 19mm with 13mm FR insulation	-/120/30		300
		Up to 9.5 & 19mm with 20mm FR insulation	-/120/30	300	
Power Cables - Copper Core	TPS	Up to 12x 2.5mm <sup>2</sup> per bundle	-/120/30	300	
	AS1530.4 Appendix D1 cable set	Applies to copper core power cables and cable trays up to 1000mm wide	-/120/30	600#	
Power Cables Aluminium Core	Single Core cables	Bundles of up to 3 x 240mm <sup>2</sup> , 4 x 120mm <sup>2</sup> and 9 x 70mm <sup>2</sup> per bundle (16x cables total)	-/120/30	300	
Communications Cables	RG6 coax	Up to 3x per bundle	-/120/30	300	
	AS1530.4 Appendix D2 cable set	Applies to copper core comms cables, including cable trays up to 1000mm wide	-/120/30	450#	
Conduits	Rigid or Flexible PVC Conduits	Up to 32mm OD (with or without cables)	-/120/30	300	

\*With or without heat trace cable

#With 300mm of loose TWrap infill packed around the services within the wrap.

# INSTALLATION STAGE 1: Slab-Mount the FyreBOX

## ALL WALLS

### MARK



Mark the location where the wall is to be constructed and position the FyreBOX Slab-Mount in the desired penetration position.

**Ensure that the FyreBOX will be located centrally to the thickness of the wall.**

### SEPARATE

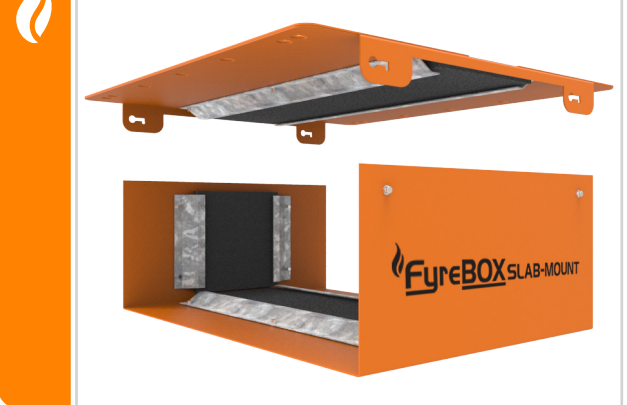

Separate the bottom section of the FyreBOX, and the foam end plugs, which are to be put in a safe location for later use.

### FIX

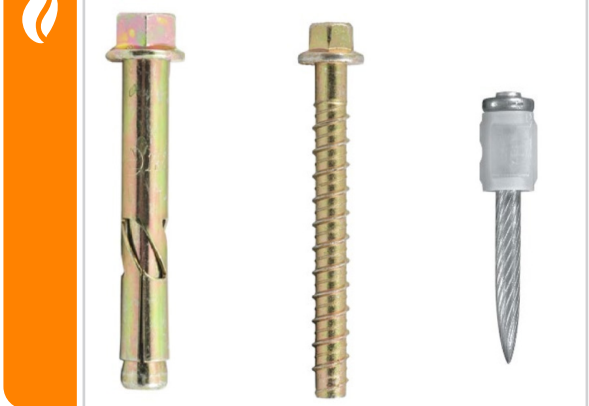

Fix the top section of the FyreBOX to the floor slab using **M6 masonry anchors, 4mmx20mm gas or powder actuated anchors** or any other **all-steel anchor** of equal pull out rating through the pre-formed mounting holes at two per side, or 300mm centres.

### SERVICES



Install services through the FyreBOX as required, ensuring all are approved for use. Please refer to the FRL tables for a list of all approved services (NB extra services can be installed at any stage of the FyreBOX installation).

Click to Watch Installation Video



# INSTALLATION STAGE 2: WALL INSTALLATION

## PLASTERBOARD AND COREX

### CLOSE



Retrieve the bottom section of the FyreBOX and fit around the services, to the secured top section, confirming that all fixing tabs are properly locked into place.

### FRAME



Install the wall's stud framing around the perimeter of the FyreBOX and fix the plasterboard as per the wall manufacturers instruction, ensuring the annular gaps between the FyreBOX and **wall openings are within 5-20mm and allow for deflection as required.**

**There is no need to line the opening around a FyreBOX with plasterboard for 60 minute applications.**

*Corex Walls require the opening to be lined with the same thickness of Corex board as is used to build the wall.*

### PLASTER



Plasterboard is applied around the FyreBOX Slab-Mount, forming annular gaps maximum 20mm. For Corex walls, the wall must be thickened on one side with 100mm wide Maxilite, 60mm thick around the penetration.

### FINISHING

Complete the installation by following the Stages 3-4 steps outlined on [pages 28-29](#)

Click to Watch Installation Video





# INSTALLATION STAGE 2: WALL INSTALLATION

## AAC PANEL WALL

**ANGLES**



Install the Hebel® wall's fixing angles on either side of the FyreBOX

**PANEL**

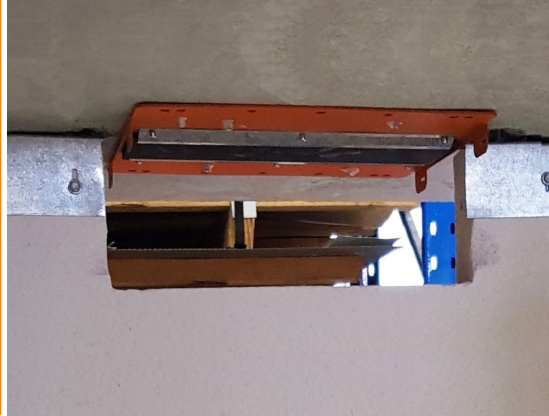

Install the Hebel® wall panel as per the supplier's instructions, ensuring the annular gaps between the FyreBOX and wall opening are within 5-20mm.

*Please note: FyreBOARD Maxilite® collar is not needed if you are planning to use the 3 – sided TWRAP™ detail which covers the casing of the FyreBOX for 90-minute insulation ratings – refer to table on [page 13](#).*

**COLLAR**



Construct a FyreBOARD Maxilite® wall collar, on one side of the penetration, by fixing 30mm thick x 100mm wide FyreBOARD Maxilite® strips around the three exposed sides of the FyreBOX. Fix FyreBOARD Maxilite® with 10g x 60mm plasterboard screws at 150mm centres and make certain that FyreBOARD Maxilite® is fixed flush with the wall opening (Trafalgar Fire strongly recommends this step is undertaken by a Trafalgar approved FyreBOX Certification Partner).

**FINISHING**

Complete the installation by following the Stages 3-4 steps outlined on [pages 28-29](#)

Click to Watch Installation Video



# INSTALLATION STAGE 2: WALL INSTALLATION

## ALPHA PANEL

### CLOSE

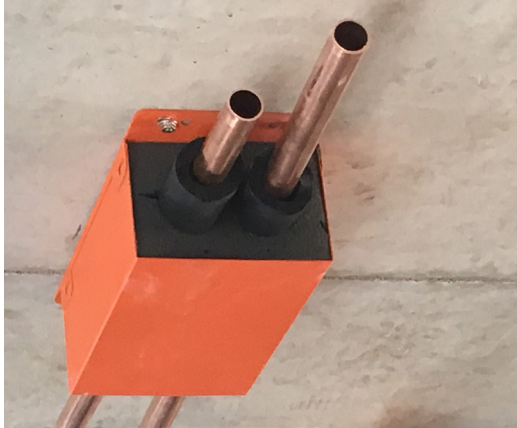

Retrieve the bottom section of the FyreBOX and fit around the services, to the secured top section, confirming that all fixing tabs are properly locked into place.

### FRAME



Install the wall's stud framing around the perimeter of the FyreBOX and fix the plasterboard as per the wall manufacturers instruction, ensuring the annular gaps between the FyreBOX and wall openings are within 5-20mm and allow for deflection as required.

*Framing only required for AlphaPanel walls that are sheeted with plasterboard on one or both sides, however even walls with just AlphaPanel require plasterboard lining, refer to the drawings at the end of the manual for specifics.*

### PLASTER



The opening is lined with FR plasterboard to assist with the performance of the FyreBOX Slab Mount system. Some Alpha Panel Walls need to be thickened with Maxilite. Depending on applications and FRL required, refer to the approvals on [page 12](#) (60 mins) and [page 16](#) (90mins).

### FINISHING

Complete the installation by following the Stages 3-4 steps outlined on [pages 28-29](#)

Click to Watch Installation Video



# INSTALLATION STAGE 2: WALL INSTALLATION

## SPEEDPANEL®

### ANGLES



Install the Speedpanel® C-Channel to the full perimeter of the FyreBOX ensuring the annular gaps between the FyreBOX and wall opening are within 5-20mm.

Install FR plasterboard to one side of the wall as per Speedpanel® installation specifications.

### PANEL

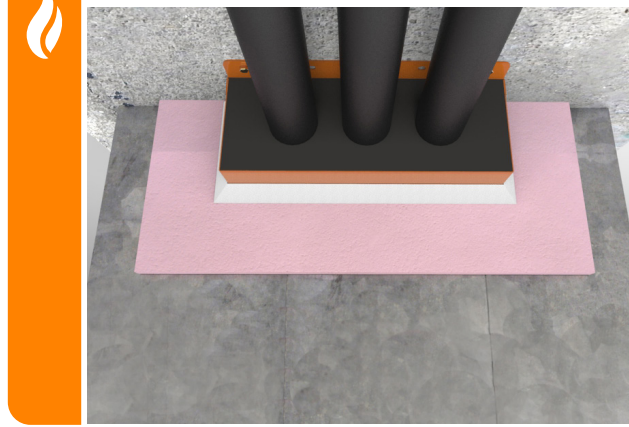

Install the Speedpanel® wall panel as per the supplier's instructions, ensuring the annular gaps between the FyreBOX and wall opening are within 5-20mm.

### COLLAR



For Speedpanel® walls less than 78mm construct a FyreBOARD Maxilite® wall collar, on one side of the penetration, by fixing 30mm thick x 100mm wide FyreBOARD Maxilite® strips around the three exposed sides of the FyreBOX. Fix FyreBOARD Maxilite® with 10g x 60mm plasterboard screws at 150mm centres and make certain that FyreBOARD Maxilite® is fixed flush with the wall opening (Trafalgar Fire strongly recommends this step is undertaken by a Trafalgar Fire approved FyreBOX Certification Partner).

### FINISHING

Complete the installation by following the Stages 3-4 steps outlined on [pages 28-29](#)

Click to Watch Installation Video





# INSTALLATION STAGE 3: FOAM INSTALLATION

## ALL WALLS

Confirm that the installation up to this point has been done in accordance with the requirements for each wall type to ensure compliance.



### SEAL



Fill all annular gaps between the FyreBOX and wall opening with FyreFLEX® Sealant to a depth of 20mm and finish with a 30x30mm fillet on each side of the penetratio (fillet not needed if penetration is wrapped with TWrap).



### FYREBOX FOAM

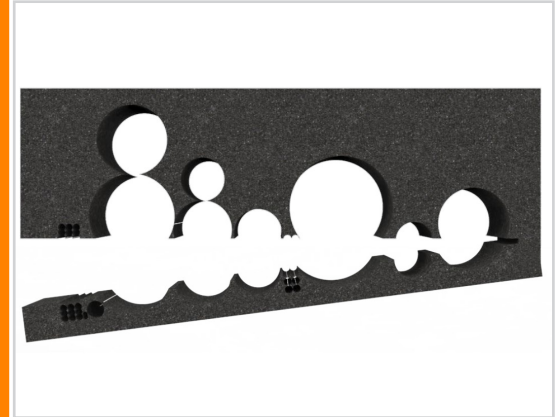

Retrieve the foam end plugs and cut a horizontal slit allowing you to open the foam. Cut out a rough profile of the services so that the foam can be fit snugly around them. Slide the foam over/around the services and into the FyreBOX

Please note: 30x30mm FyreFLEX® fillet is not needed if you are planning to use the 3 – sided TWRAP™ detail as shown on [page 29](#).



### FOAM EXAMPLE



Plug any visible gaps in the end plugs with left over foam off cuts or FyreFLEX® Sealant. Note: It is recommended that after the foam is installed, a photograph should be taken for site records to demonstrate a compliant foam installation.



### FILL FOAM GAPS



Click to Watch Installation Video



# INSTALLATION STAGE 4: WRAPPING

## ALL WALLS

If TWRAP™ is required for the services to achieve the insulation rating as described in the tables on pages 8-22, install as follows.

### WRAP- SERVICES ONLY



In some instances, it is appropriate to For a 60 minutes insulation, simply wrap TWRAP™ around the required (or all services), ensuring each end overlaps by 50mm, and butt it up against the FyreBOX's foam end plugs. Secure the TWRAP™ in three locations with reinforced aluminium tape or stainless-steel cable ties around the entire circumference. Contact [technical@tgroup.com.au](mailto:technical@tgroup.com.au) to see if this is appropriate on your site.

### WRAP UP TO 120MIN



For 90 or greater minutes insulation, simply wrap TWRAP™ around the services and FyreBOX casing, flaring the edges out against the underside of the slab. These edges should overlap the slab by at least 50mm and be held in place by 30x1x300mm flat steel tabs. Refer to install drawing below.

Some instances don't need any TWrap at all, check the FRL tables or contact [technical@tgroup.com.au](mailto:technical@tgroup.com.au) to confirm.

### TWRAP - 3-Sided Wrap

Where the FyreBOX configuration does not achieve full insulation in a given fire barrier, TWRAP will need to be applied to the FyreBOX casing and services in order to increase their insulation rating up to -/XXX/120.

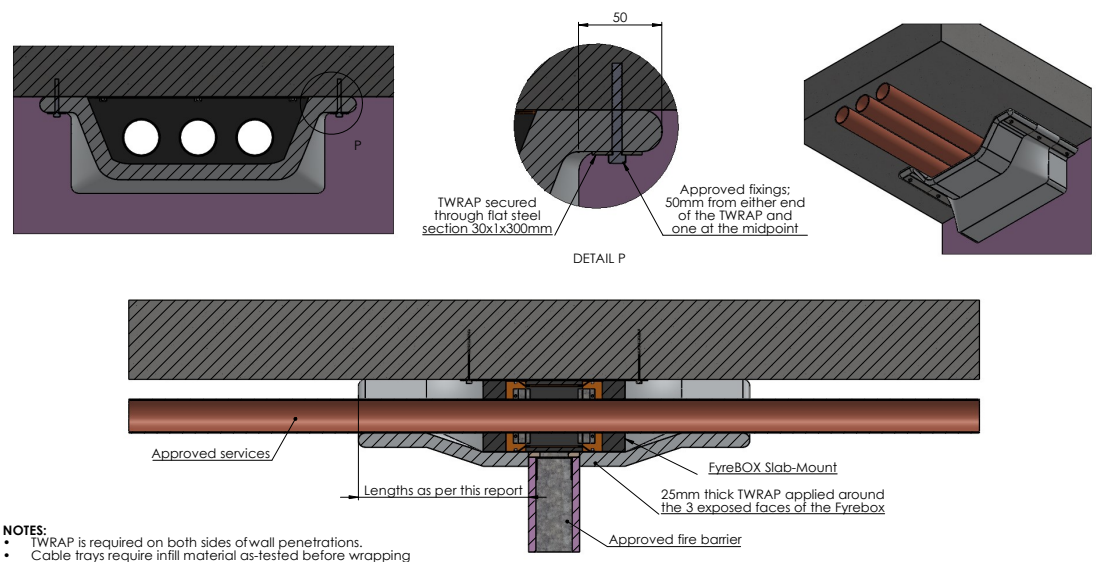

- NOTES:
- TWRAP is required on both sides of wall penetrations.
  - Cable trays require infill material as-tested before wrapping

Click to Watch Installation Video



# INSTALLATION ALTERNATIVES

# RISER SHAFT

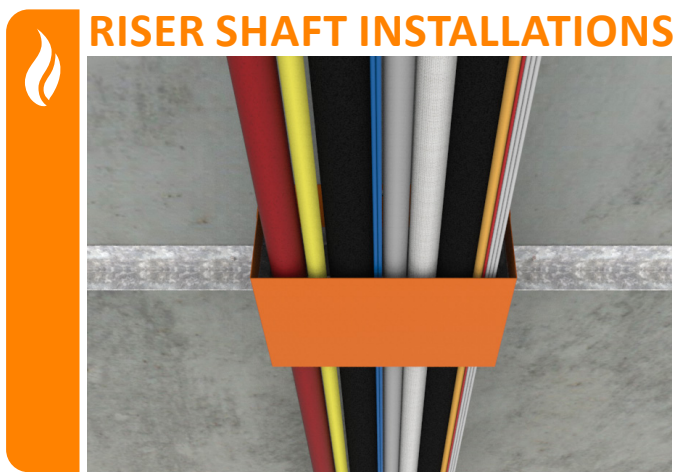

Where the FyreBOX cannot be centered in the wall due to narrow risers or slab edges being nearby.

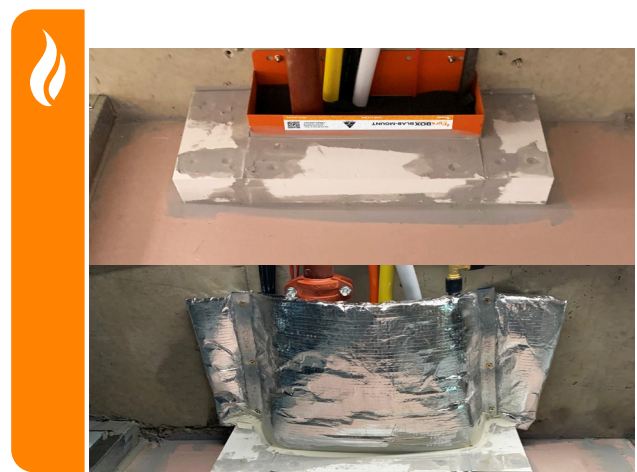

The FyreBOX can be installed offset to the wall using strips of FyreBOARD Maxilite® to locally thicken the penetration.

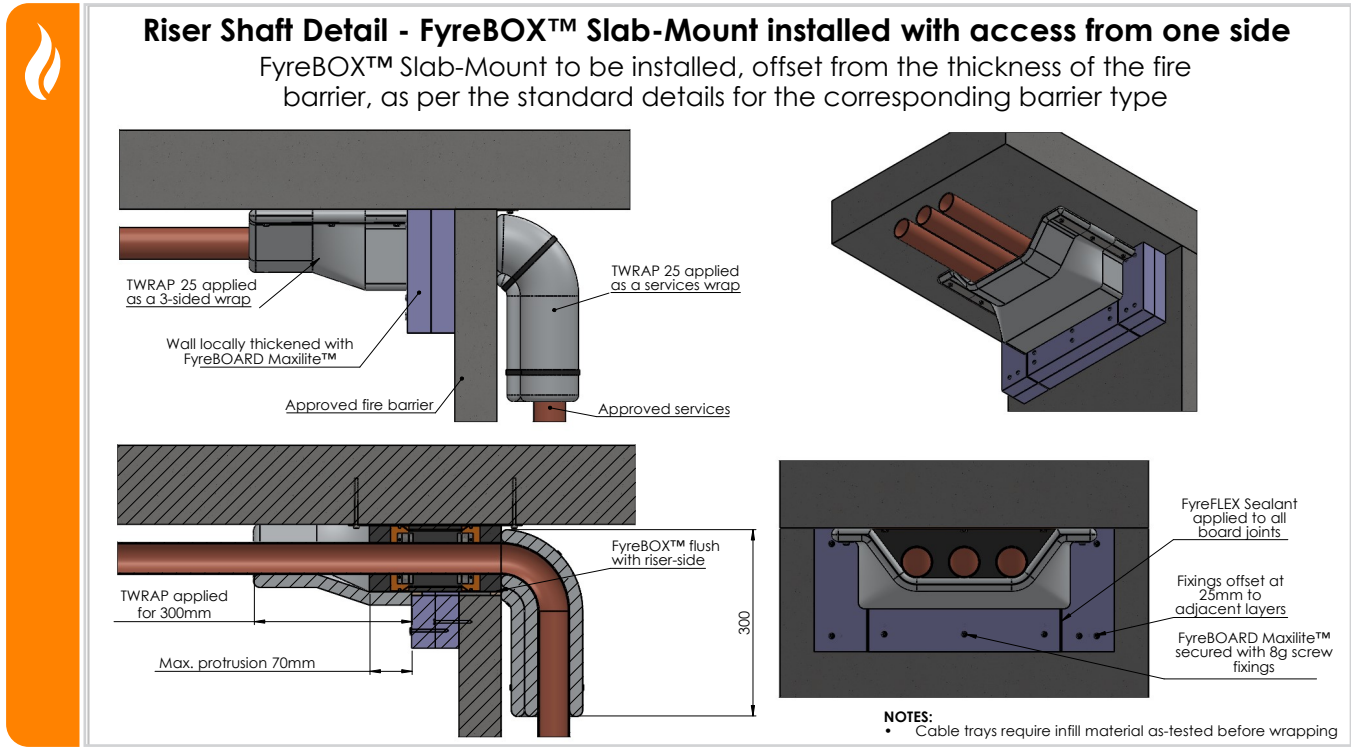

Click to Watch Installation Video





# INSTALLATION ALTERNATIVES

## STEPPED SLAB, WALL JUNCTIONS & OVERSIZED OPENINGS

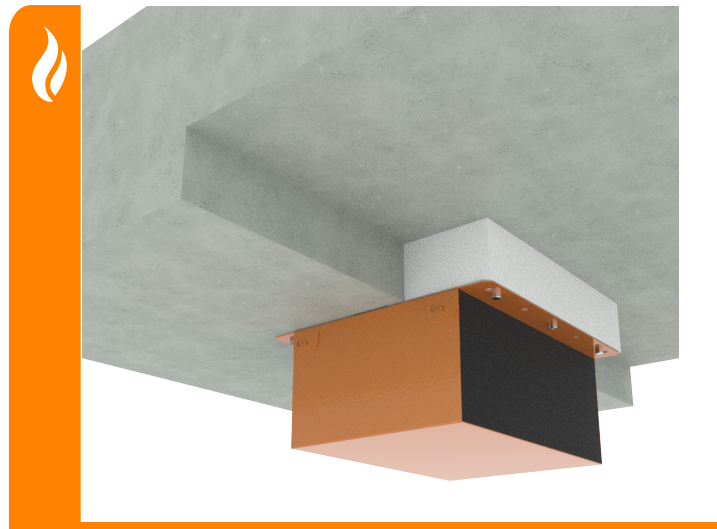

### Oversized Openings

For openings cut too large, up to 60mm FyreBOARD Maxilite can be used to pack out the opening and reduce the annular gap. This can also be done on the sides of the FyreBOX to reduce the width of the penetration. [Refer to page 53 for Technical Drawing.](#)



### Wall Junctions

For FyreBOX Slab-Mount systems installed against adjacent barriers, FyreFLEX Sealant is applied to the perimeter (20mm depth) of the box so daylight cant be seen through, and TWrap can be installed 2-sided to the soffit and the wall. [Refer to page 54 for Technical Drawing.](#)

### Stepped Slabs

Where a step up in the slab is present, FyreBOARD Maxilite can be used to pack out the gap to the FyreBOX Slab-Mount. Suitable for steps up to 60mm, with min 100mm long fixings used to secure the FyreBOX Slab-Mount to the concrete through the Maxilite Board. [Refer to page 52 for Technical Drawing.](#)

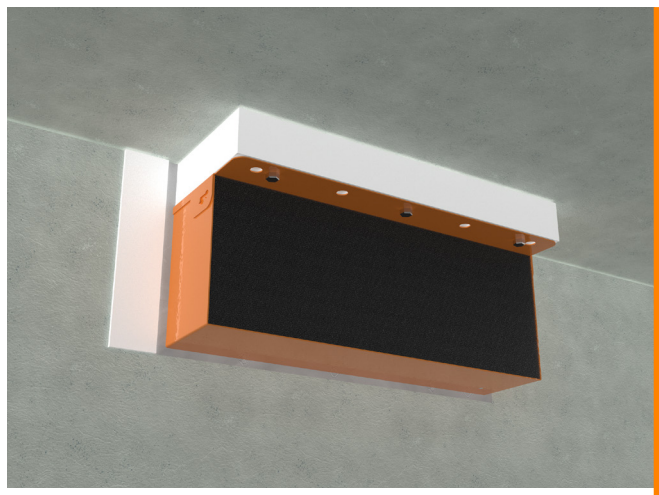

### Wall Junctions

For FyreBOX Slab-Mount systems installed against adjacent barriers, FyreFLEX Sealant is applied to the perimeter (20mm depth) of the box so daylight cant be seen through, and TWrap can be installed 2-sided to the soffit and the wall. [Refer to page 54 for Technical Drawing.](#)

# INSTALLATION ALTERNATIVES

## FYREBOX DOUBLE VERTICAL

### FYREBOX DOUBLE VERTICAL

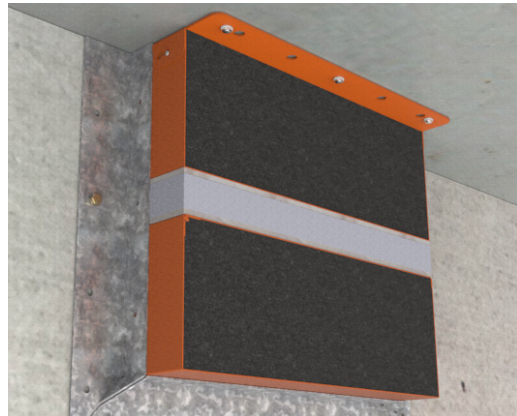

Where a large run of services needs firestopping in a small width of wall.

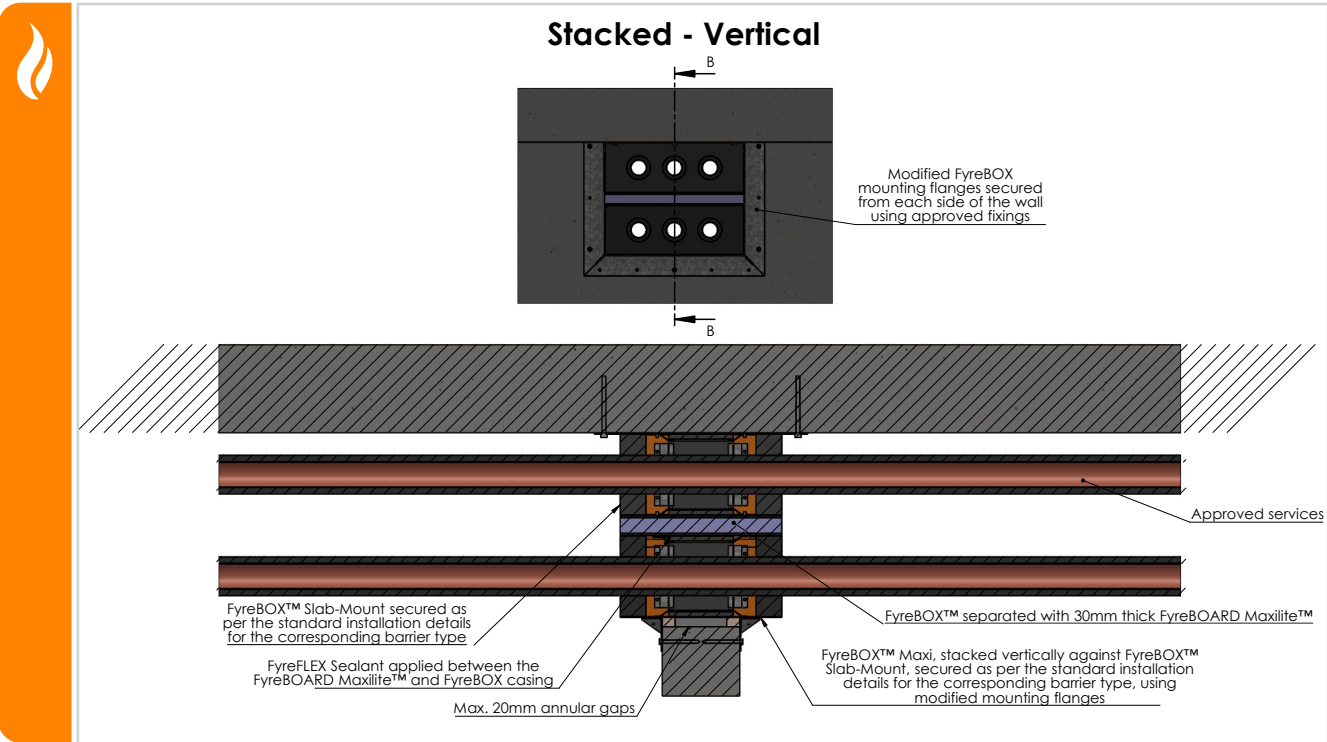

Click to Watch Installation Video



# INSTALLATION ALTERNATIVES

## FYREBOX DOUBLE HORIZONTAL



For where large amounts of services exit a riser shaft wall.



Double vertical FyreBOX installed above a doorway to allow for the provision of large amounts of services in a small space.

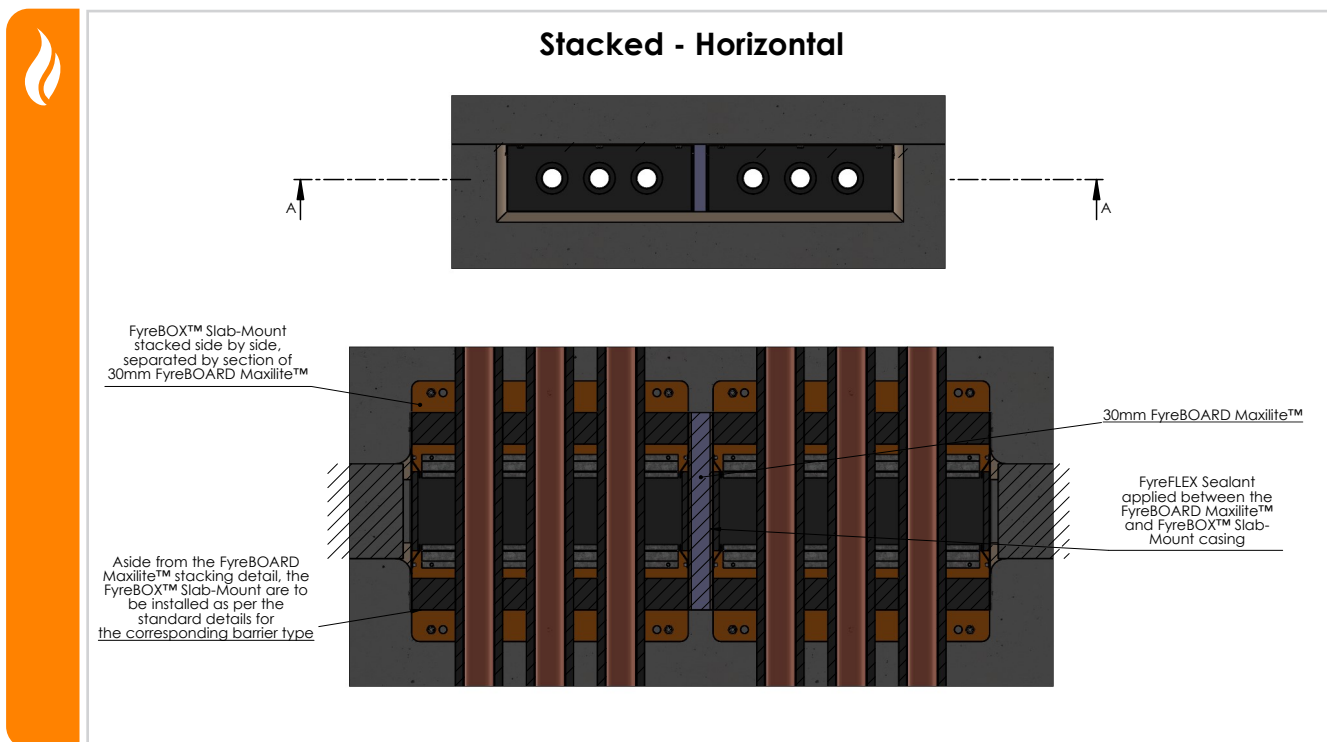

Click to Watch Installation Video



# INSTALLATION ALTERNATIVES

## INTRWALL / PARTY WALLS

If TWRAP™ is required for the services to achieve the insulation rating as described in the tables on pages 6-15, install as follows.

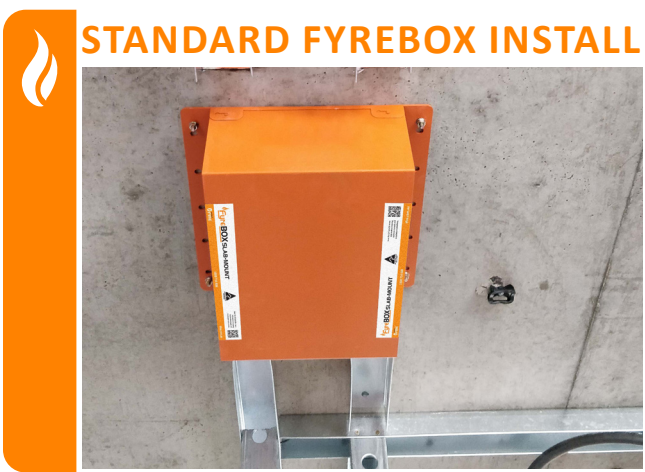

### STANDARD FYREBOX INSTALL

FyreBOX top plate, body and approved services all installed as standard to the soffit, with foam end plugs installed around the services.



### INSTALL WALL

Install the wall as per the manufacturer's instruction.

## FINISH

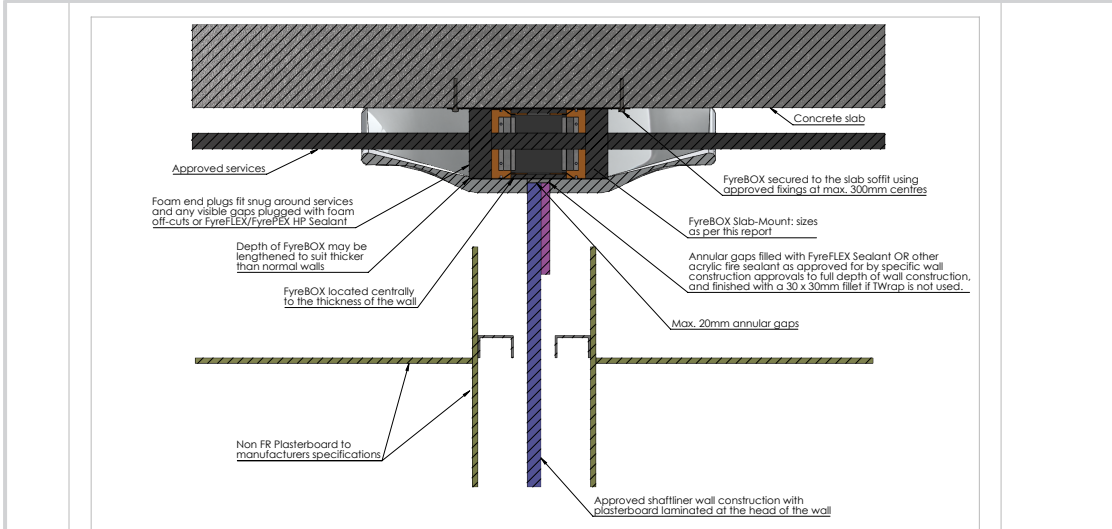

<b>Drawing Name:</b> Head of Party Wall Penetration		Test Standard: AS1530.4	Codes:	Revision:	Date:	No.:	NOTICE
<b>Project Title:</b> FyreBOX Slab-Mounted - Generic Install		Fire resistance level:	Drawn By: SM				
<b>Drawing No.:</b> 1	<b>Sheet:</b> 1 of 1	<b>Date:</b> 26/08/2022	<b>Scale:</b> NTS				

Click to Watch Installation Video



If the wall does not already require it, install a layer of FR plasterboard at the head of the wall. Install the FyreFLEX Sealant to the full depth of the plasterboard & TWrap to the required length.



# INSTALLATION CHECKLIST

## PLASTERBOARD

FyreBOX Label/Identifier No. \_\_\_\_\_

Installer Name: \_\_\_\_\_

Company: \_\_\_\_\_

Site: \_\_\_\_\_

Floor/Level: \_\_\_\_\_ FRL \_\_\_\_\_

Installation Checklist		Satisfactory	Action Required
1	Is the FyreBOX located centrally to the thickness of the wall?		
2	Are correct fixings (M6 masonry Anchors, 4mm gas or powder actuated anchors, or any other steel anchor of equal pull out rating ) used to fix the top side of FyreBOX onto the floor slab?		
3	Are there 2 fixings per side, or maximum gap between the anchors at 300mm?		
4	Does the size of the wall opening allow for annular gap between the opening and FyreBOX within 5 to 20 mm?		
5	Are the services running through the FyreBOX as per the approved services list on the technical manual?		
6	Is the stud framing around the perimeter of the box installed as per the wall manufacturer's instructions?		
7	Is the sealant applied to correct depth of 20 mm on each side with a (fillet size of approximately 30x30mm) Note: If 3-sided wrap is used, fillet not required		
8	Is the foam snugly fit around the services and any visible gaps covered with foam off-cuts or FyreFLEX® sealant?		
<b>Services only wrap (if applicable)</b>			
1	Does the TWRAP™ wrap around the services and overlaps itself by 50mm?		
2	Is the TWRAP™ butted against the FyreBOX foam and end plugs?		
3	Is the TWRAP™ secured in three locations with reinforced aluminium tape or stainless-steel cable ties around the entire circumference?		
<b>3-sided wrap (if applicable)</b>			
1	Does the TWRAP™ cover the services including the FyreBOX and flaring at least 50mm at edges and against the slab?		
2	Is the correct steel tab (30x1x300mm) used to hold the TWRAP™ in place on both sides of the FyreBOX?		
3	Are correct fixings M6 masonry Anchors used to fix the steel tab and TWRAP™ onto the floor slab, 3x per side?		
4	Is the TWRAP™ butted up against the wall, around the box?		

For a full list of installation instructions, refer to the installation [pages 23-34](#) of this FyreBOX Slab-Mount Technical Manual.

# INSTALLATION CHECKLIST

## AAC PANEL WALL

FyreBOX Label/Identifier No. \_\_\_\_\_

Installer Name: \_\_\_\_\_

Company: \_\_\_\_\_

Site: \_\_\_\_\_

Floor/Level: \_\_\_\_\_ FRL \_\_\_\_\_

Installation Checklist		Satisfactory	Action Required
1	Is the FyreBOX located centrally to the thickness of the wall?		
2	Are correct fixings (M6 masonry Anchors, 4mm gas or powder actuated anchors, or any other steel anchor of equal pull out rating ) used to fix the top side of FyreBOX onto the Floor slab?		
3	Are there 2 fixings per side, or maximum gap between the anchors at 300mm?		
4	Does the size of the wall opening allow for annular gap between the opening and FyreBOX within 5 to 20 mm?		
5	Are the services running through the FyreBOX as per the approved services list on the technical manual?		
6	Are the Hebel® wall's head track angles installed as per the wall manufacturer's instructions on both sides?		
7	Is the sealant applied to correct depth of 20 mm on each side with a (fillet size of approximately 30x30mm) Note: If 3-sided wrap is used, fillet not required		
8	Is the foam snugly fit around the services and any visible gaps covered with foam off-cuts or FyreFLEX® sealant?		
<b>Services only wrap (if applicable)</b>			
1	Is the FyreBOARD Maxilite® wall collar constructed correctly? (One side of the penetration using three 30mm thick x 100 mm FyreBOARD Maxilite® strips) *(FyreBOARD Maxilite® collar not needed if planning to use 3-sided TWRAP™)		
2	Are the boards fixed using 10gx60mm plasterboard screws at 150mm centres and flush with the wall opening?		
3	Is the resulting gap sealed with FyreFLEX® Sealant (full depth and fillet size of 30x30mm)?		
4	Does the TWRAP™ wrap around the services and overlaps itself by 50mm? (TWRAP™ only needs to be applied on conductive services)		
5	Is the TWRAP™ butted against the FyreBOX foam and end plugs?		
6	Is the TWRAP™ secured in three locations with reinforced aluminium tape or stainless-steel cable ties around the entire circumference?		
<b>3-sided wrap (if applicable)</b>			
1	Does the TWRAP™ cover the services including the FyreBOX and flaring at least 50mm at edges and against the slab?		
2	Is the correct steel tab (30x1x300mm) used to hold the TWRAP™ in place on both sides of the FyreBOX?		
3	Are correct fixings M6 masonry Anchors used to fix the steel tab and TWRAP™ onto the Floor slab, 3x per side?		
4	Is the TWRAP™ butted up against the wall, around the box?		

For a full list of installation instructions, refer to the installation [pages 23-34](#) of this FyreBOX Slab-Mount Technical Manual.



Click here to go back to Contents

# SYSTEM RANGE



## FyreBOX SLAB-MOUNT



Item Number	Description	Dimensions
FYREBOX-SM-BAMBINO	160 x125 x 250mm	
FYREBOX-SM-350	350 x 125 x 250mm	
FYREBOX-SM-550	550 x 125 x 250mm	
FYREBOX-SM-650	650 x 125 x 250mm	
FYREBOX-SM-Custom	Any size from 100 up to 1250 x 125 x 250mm	

# SYSTEM COMPONENTS



Item Number	Description	Min Order Qty
TWRAP- 300 x 810mm	300 x 810 x 25mm Pre Cut Strip	1
TWRAP- 300 x 1010mm	300 x 1010 x 25mm Pre Cut Strip	1
TWRAP Roll- 300mm	300 x7620 x 25mm Full Roll	1
Maxilite Strips FYREBOX SM 350	1 Strip at 580 x 100 x 30mm 2 Strips at 145 x 100 x 30mm	-

## COMPLIANCE



## COMPLIANCE WITH THE NATIONAL CONSTRUCTION CODE (NCC)

Formerly known as BCA

Under the NCC requirements, a multiple service transit system for service penetrations should be fire tested in every configuration that it is intended for use in, both completely empty (blank seal), partially full and completely full of services so that the product may be installed with as many or as little services as required on site. It is important to fire test in all the different walls types and with different configurations, quantities and types of services which is a time consuming (and expensive) exercise.

Trafalgar Fire FyreBOX systems have been fire tested extensively to AS1530.4-2014 and approved in accordance with Section 4 AS4072.1 as required by Schedule 5 of the NCC. This includes over 200 hours of accredited furnace time and 30 plus individual test reports to cover the full range of service and wall configurations that allow us to comfortably stand behind our multiple SYSTEM approvals.

These configurations include but are not limited to:

- Service fill ratio: Empty (blank seal), half full and completely full of services
- Barrier types: Various types of plasterboard, concrete, Blockwork, Hebel®, Walsc®, Speedpanel®, Pronto panel, FyreBOARD Maxilite®, concrete floors, plasterboard ceilings, corex walls etc
- Services: Bare and insulated metal pipes, cable trays and cable bundles, aluminium cables, PVC pipes & conduits, PEX and PEX-AL-PEX pipes, cPVC pipes etc
- Configurations: Blank seal (empty), full of services, double stacked, side by side etc
- Insulation performance: Tested both wrapped and unwrapped with TWRAP™ to ensure the system works in both configurations
- Penetration sizes: 150 x 125, 350x125, 550x125, 1100x125
- FyreBOX Variants: Slab-Mount, Slab-Mount Bambino, Cast-in, Maxi & Mini (retrofit)

When choosing a multiple service transit penetration system like FyreBOX, it is important to check that all aspects of your system have been fire tested and are fit for purpose.

*Compliance will only be achieved when the installation on site mirrors the tested system.*

## TEST AND ASSESSMENT REPORTS

The above-mentioned fire testing reports have all been conveniently summarised into **BRANZ assessment report FC10266 (available on [www.tfire.com.au](http://www.tfire.com.au))** which neatly tabulates the approved services in a range of fire barriers, for all FyreBOX variants and applications, and covers only minor variations to the tested systems, thereby providing trouble free certification according to NCC.

Importantly, every aspect of the assessment report are backed up by the fire test data and the individual fire test reports are available on request for certification purposes.

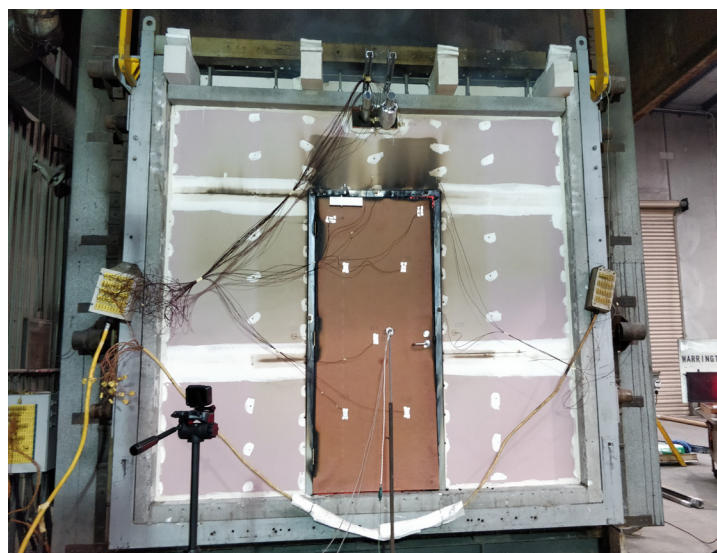

## FyreBOX Slab-Mount - Installation Overview

STEP 1

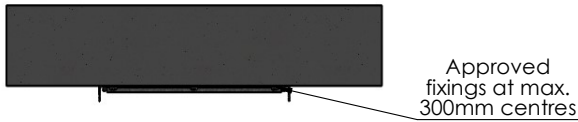

Secure top-section of FyreBOX to slab soffit, ensuring it will be located centrally to the thickness of the wall

STEP 2

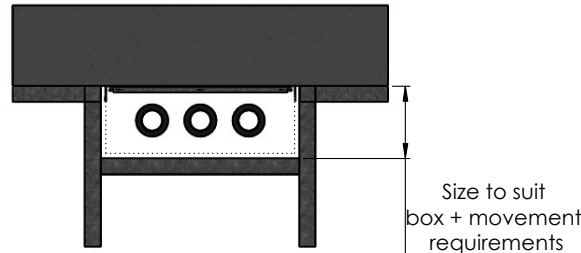

Run approved services through the FyreBOX, ensuring they will be located within the completed FyreBOX opening.

**NOTE:** Services can be run at any stage of the install

STEP 3

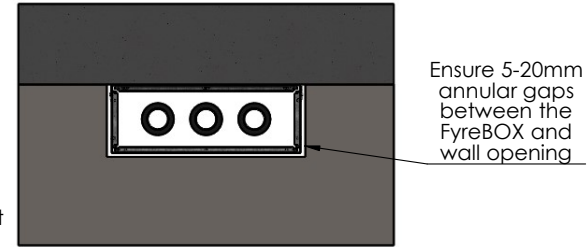

Clip together the bottom-section of the FyreBOX and construct the approved fire wall

**NOTE:** The FyreBOX Slab-Mount can also be retrofit into existing wall systems

STEP 4

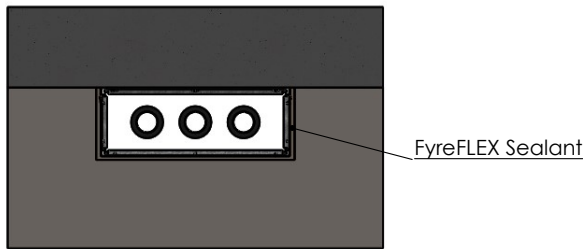

Fill annular gaps with FyreFLEX Sealant to a depth of at least 20mm, from each side of the wall

STEP 5

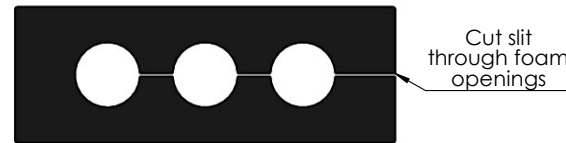

Retrieve foam end plugs and form openings to match the services within the FyreBOX. Cutting a slit through these openings will allow for the plug to be opened and inserted around the existing services

STEP 6

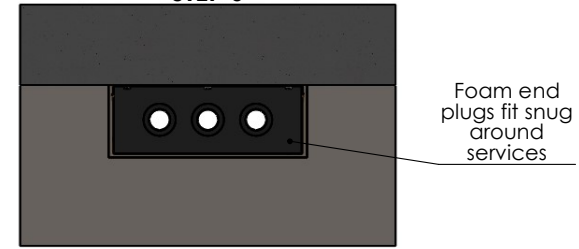

Fit foam end plugs tightly around the services, from each side of the FyreBOX, and plug any gaps with foam off cuts or FyreFLEX/FyrePEX HP Sealant. Continue to TWRAP drawings if wrapping will be required for full insulation.

**NOTE:** This is a generic installation guide. For specific details relevant to each barrier type, please refer to the corresponding installation drawing.

<b>Drawing Name:</b> Installation Overview				<b>Test Standard:</b> AS1530.4	<b>Codes:</b>	<b>Revision:</b>	<b>Date:</b>	<b>No.:</b>	<b>NOTICE:</b>
<b>Project Title:</b> FyreBOX Slab-Mount - Generic Install				<b>Fire resistance level:</b>	<b>Drawn By:</b> JC	<small>NOTE: ALL DIMENSIONS ARE IN MILLIMETRES (mm)</small> 			
<b>Drawing No. :</b> 2	<b>Sheet:</b> 2 of 19	<b>Date:</b> 27/05/2020	<b>Scale:</b> NTS	<b>Based on Report No.:</b>	<b>Checked By:</b> CT				

## Plasterboard framing details

Option A - Full-width nogging between studs  
Recommended for areas above fire doors

Option B - Head track contoured around opening  
Recommended for penetrations remote from fire doors

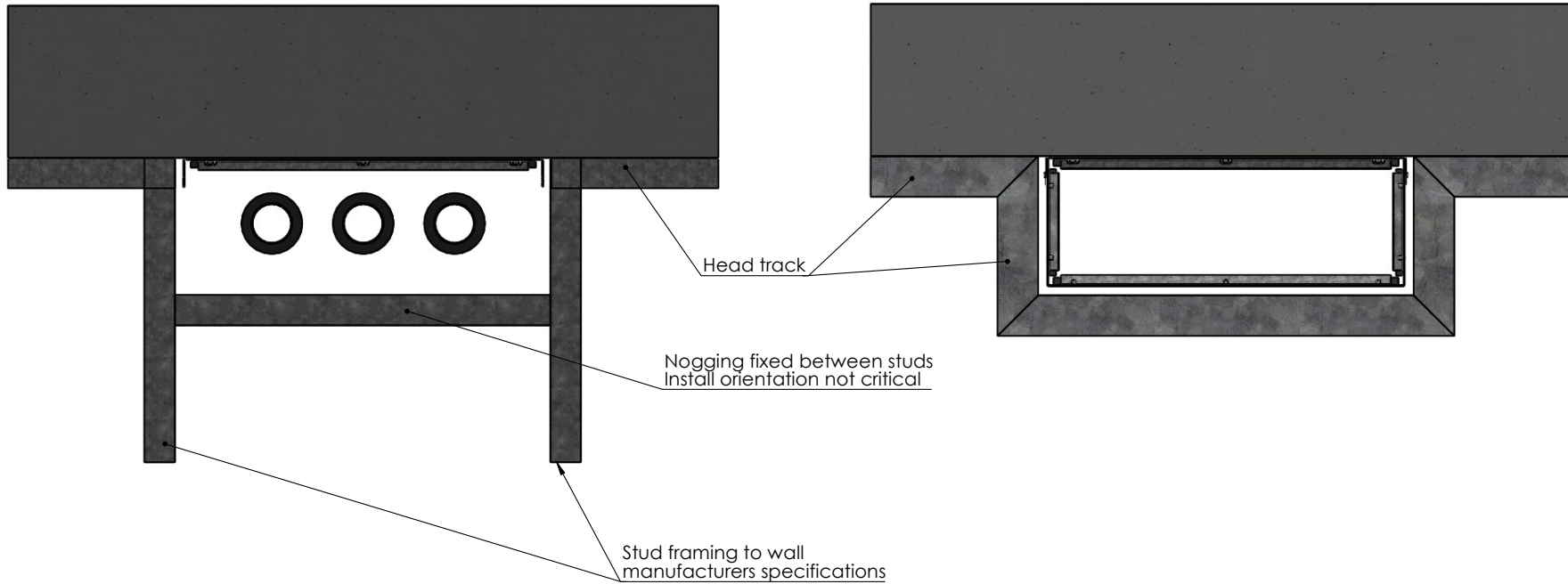

**Notes:**

- Both options are as-tested
- Both options have been tested without the opening being lined with plasterboard
- When located above fire doors, option A is the recommended installation detail
- Openings are to allow sufficient clearance for building movement

<b>Drawing Name:</b> Plaster framing details				<b>Test Standard:</b> AS1530.4	<b>Codes:</b>	<b>Revision:</b>	<b>Date:</b>	<b>No.:</b>	<b>NOTICE:</b>
<b>Project Title:</b> FyreBOX Slab-Mount - Generic Install				<b>Fire resistance level:</b>	<b>Drawn By:</b> JC				<small>NOTE: ALL DIMENSIONS ARE IN MILLIMETRES (mm)</small>
<b>Drawing No. :</b> 3	<b>Sheet:</b> 3 of 19	<b>Date:</b> 27/05/2020	<b>Scale:</b> NTS	<b>Based on Report No.:</b>	<b>Checked By:</b> CT	<input type="checkbox"/> STANDARD DRAWING <input type="checkbox"/> PROJECT DRAWING			

## Standard Plasterboard Walls

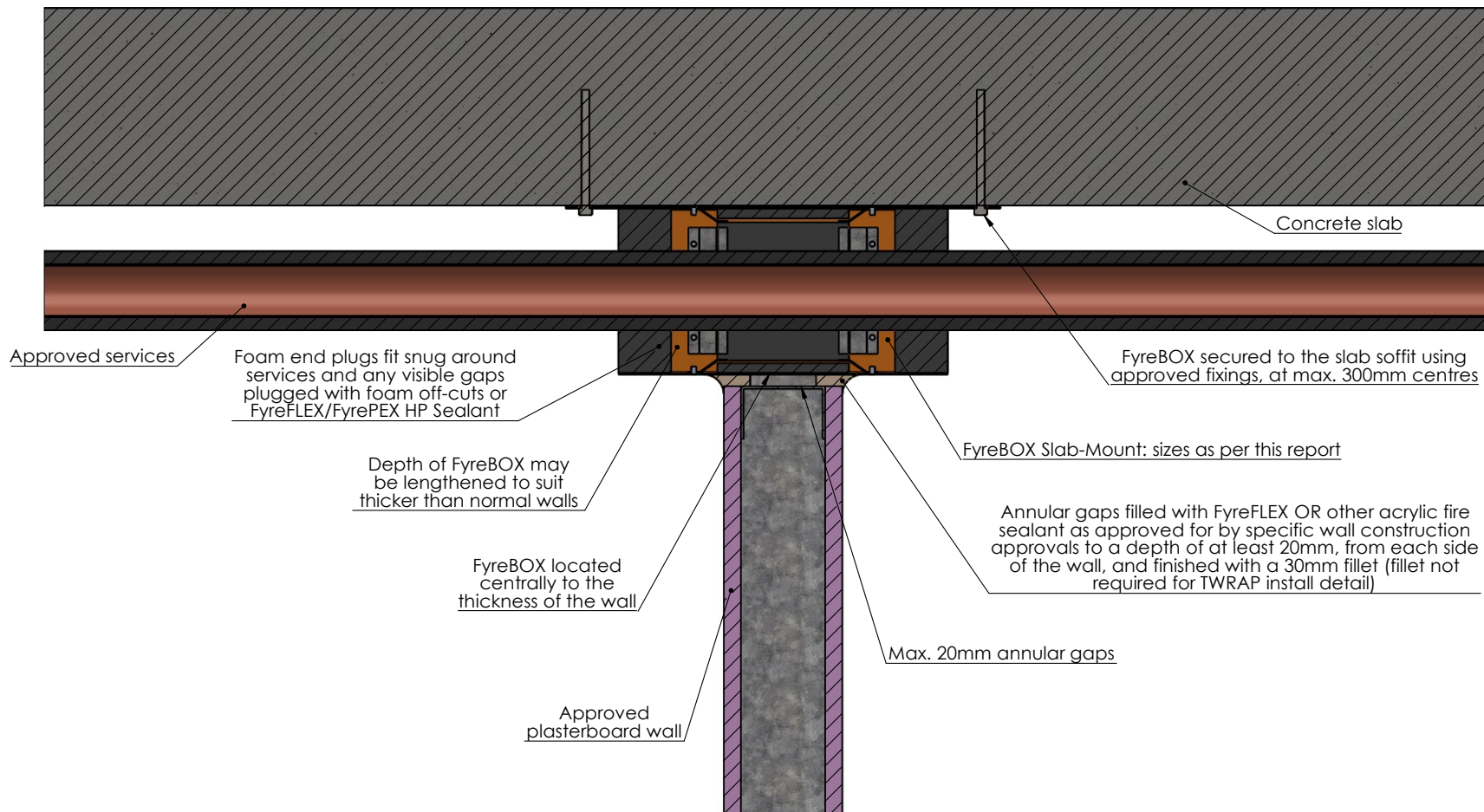

<b>Drawing Name:</b> Standard Plasterboard				<b>Test Standard:</b> AS1530.4	<b>Codes:</b>	<b>Revision:</b>	<b>Date:</b>	<b>No.:</b>	<b>NOTICE:</b>
<b>Project Title:</b> FyreBOX Slab-Mount - Generic Install				<b>Fire resistance level:</b>	<b>Drawn By:</b> JC	<small>NOTE: ALL DIMENSIONS ARE IN MILLIMETRES (mm)</small>			
<b>Drawing No. :</b> 4	<b>Sheet:</b> 4 of 19	<b>Date:</b> 27/05/2020	<b>Scale:</b> NTS	<b>Based on Report No.:</b>	<b>Checked By:</b> CT	<input type="checkbox"/> STANDARD DRAWING <input type="checkbox"/> PROJECT DRAWING			



### ShaftLiner Walls

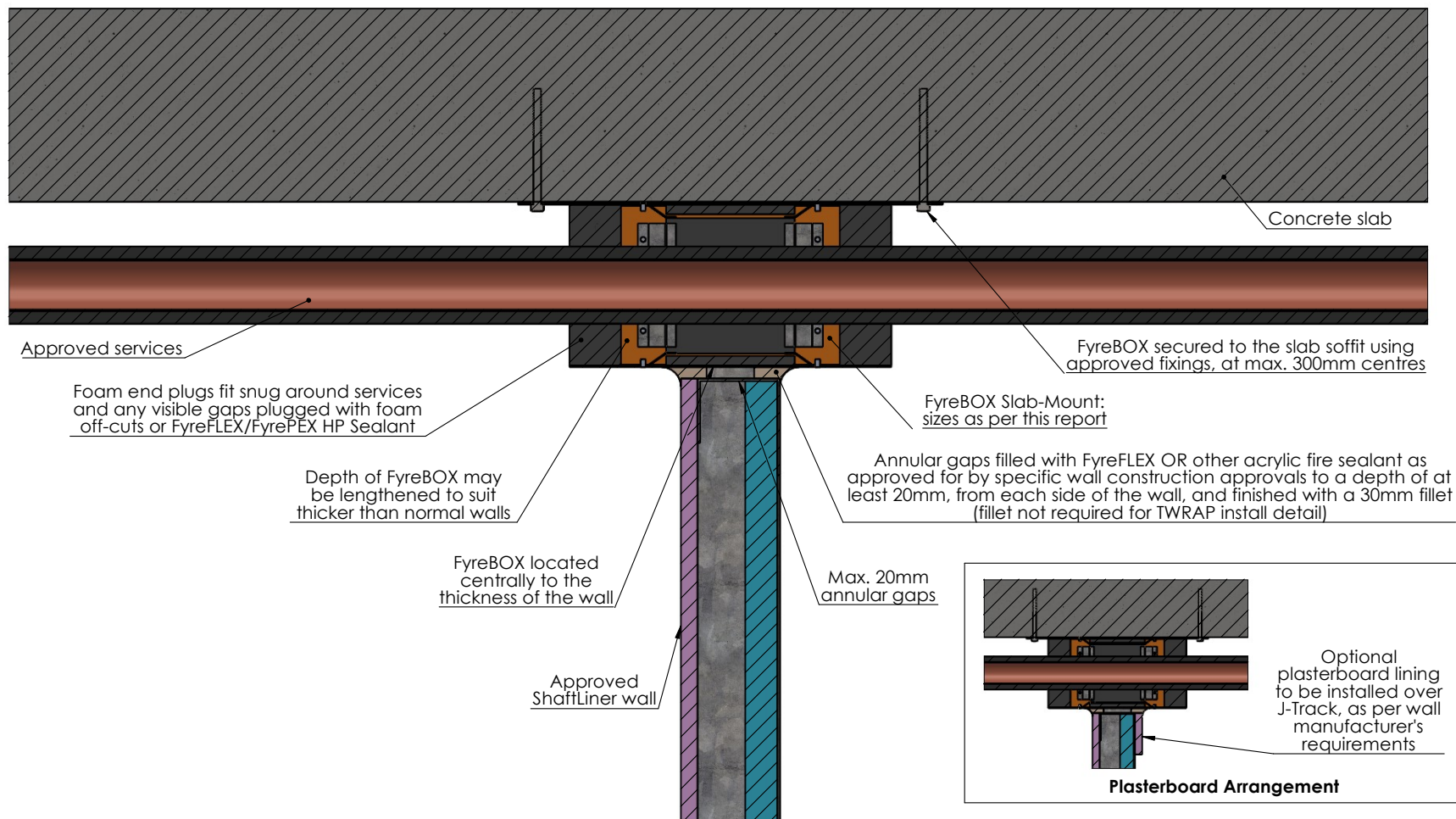

<b>Drawing Name:</b> ShaftLiner				<b>Test Standard:</b> AS1530.4	<b>Codes:</b>	<b>Revision:</b>	<b>Date:</b>	<b>No.:</b>	<b>NOTICE:</b>
<b>Project Title:</b> FyreBOX Slab-Mount - Generic Install				<b>Fire resistance level:</b>	<b>Drawn By:</b> JC				<small>NOTE: ALL DIMENSIONS ARE IN MILLIMETRES (mm)</small>
<b>Drawing No. :</b> 6	<b>Sheet:</b> 6 of 19	<b>Date:</b> 27/05/2020	<b>Scale:</b> NTS	<b>Based on Report No.:</b>	<b>Checked By:</b> CT	<input type="checkbox"/> STANDARD DRAWING <input type="checkbox"/> PROJECT DRAWING			





## Hebel/Walsc AAC Walls - Openings up to 400x170mm

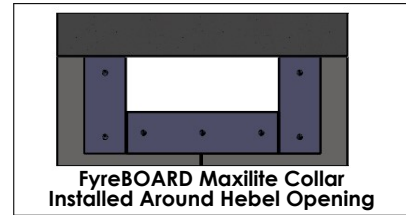
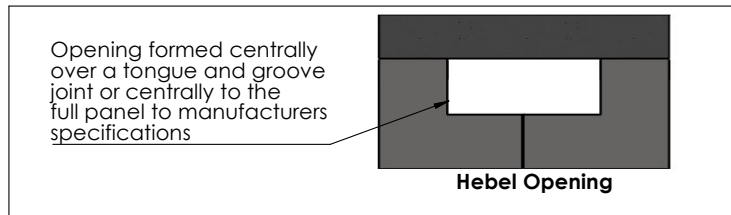
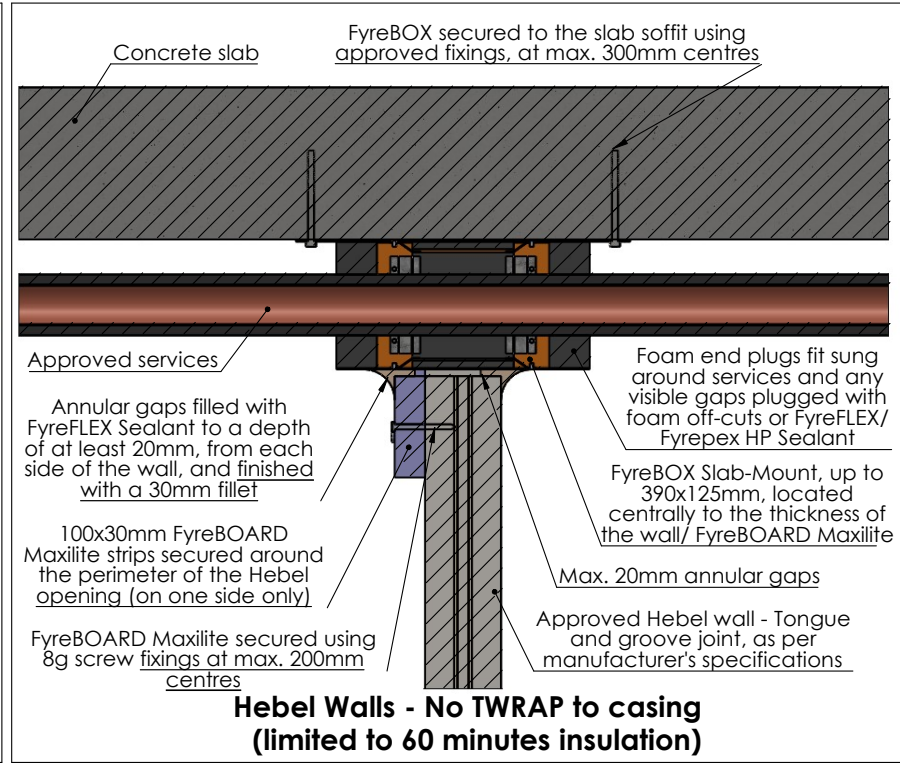
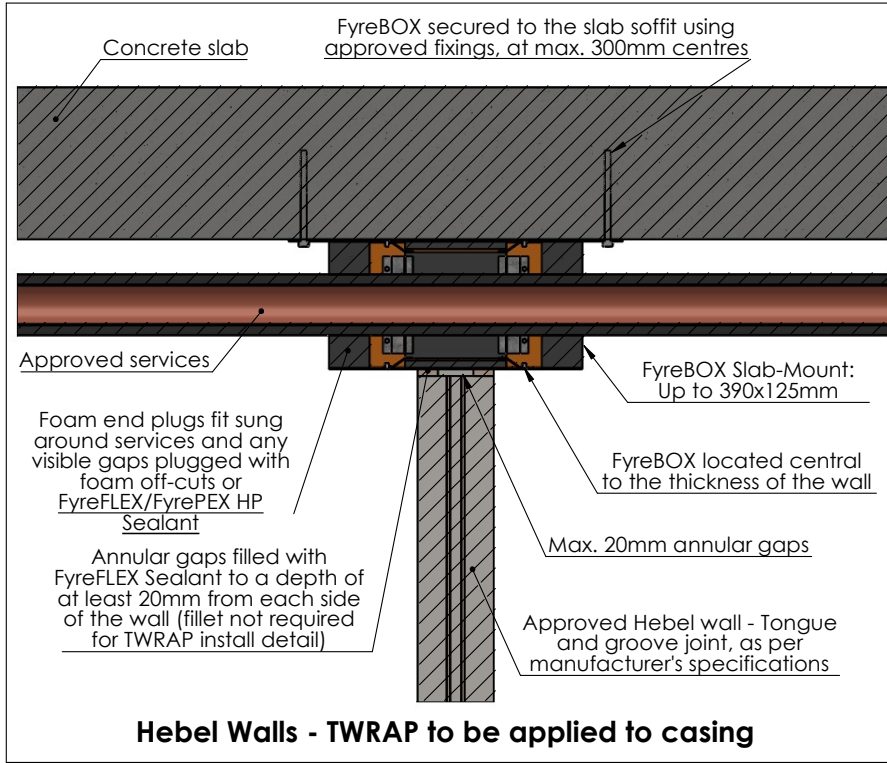

<b>Drawing Name:</b> Hebel/Walsc - Small Openings				<b>Test Standard:</b> AS1530.4	<b>Codes:</b>	<b>Revision:</b>	<b>Date:</b>	<b>No.:</b>	<b>NOTICE:</b> <small>NOTE: ALL DIMENSIONS ARE IN MILLIMETRES (mm)</small>
<b>Project Title:</b> FyreBOX Slab-Mount - Generic Install				<b>Fire resistance level:</b>	<b>Drawn By:</b> JC				
<b>Drawing No.:</b> 7	<b>Sheet:</b> 7 of 19	<b>Date:</b> 27/05/2020	<b>Scale:</b> NTS	<b>Based on Report No.:</b>	<b>Checked By:</b> CT	<input type="checkbox"/> STANDARD DRAWING <input type="checkbox"/> PROJECT DRAWING			

## Hebel/Walsc AAC Walls - Openings greater than 400x170mm

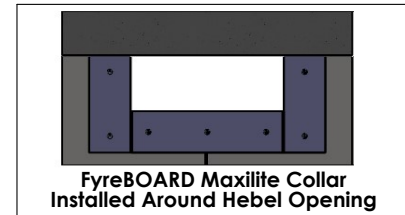
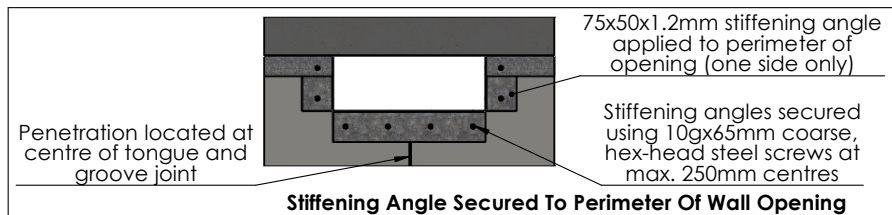
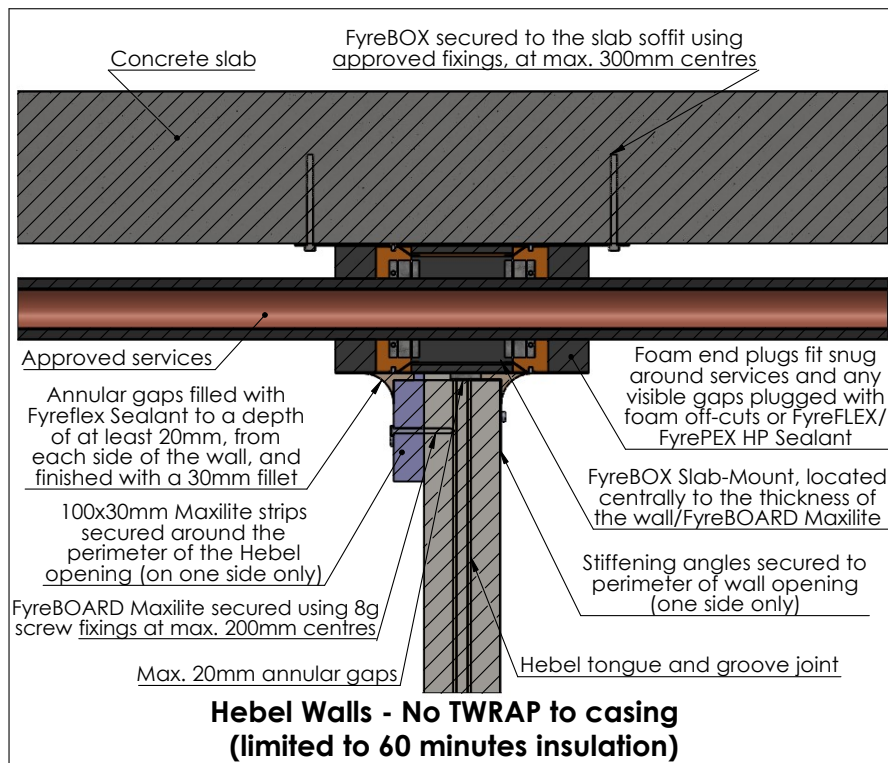
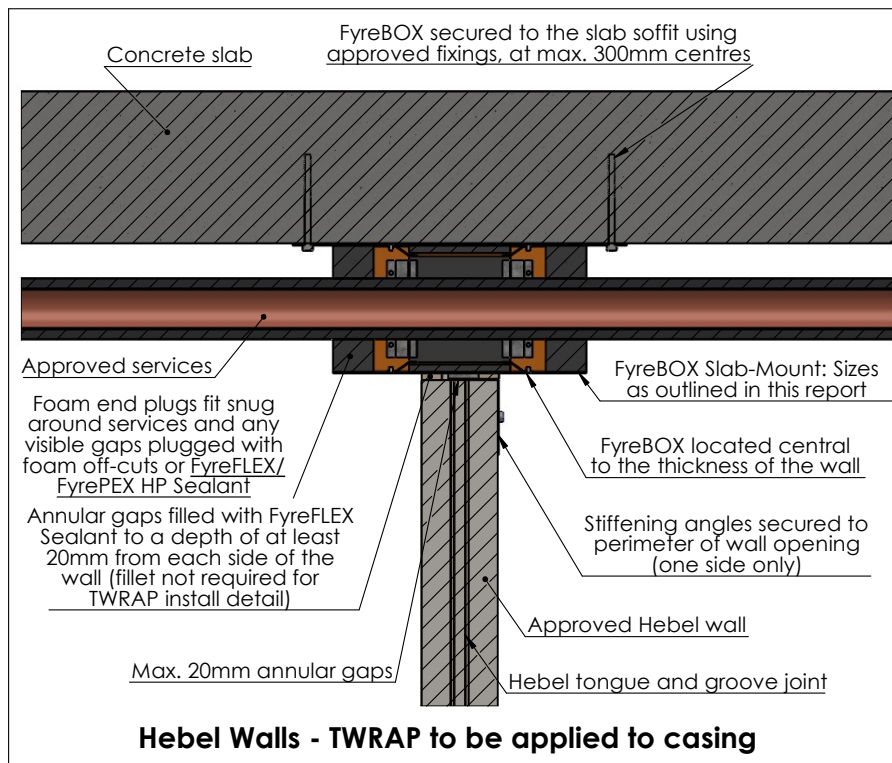

<b>Drawing Name:</b> Hebel/Walsc - Large Openings				<b>Test Standard:</b> AS1530.4	<b>Codes:</b>	<b>Revision:</b>	<b>Date:</b>	<b>No.:</b>	<b>NOTICE:</b>
<b>Project Title:</b> FyreBOX Slab-Mount - Generic Install				<b>Fire resistance level:</b>	<b>Drawn By:</b> JC	NOTE: ALL DIMENSIONS ARE IN MILLIMETRES (mm)			
<b>Drawing No. :</b> 8	<b>Sheet:</b> 8 of 19	<b>Date:</b> 27/05/2020	<b>Scale:</b> NTS	<b>Based on Report No.:</b>	<b>Checked By:</b> CT				



### SpeedPanel Walls

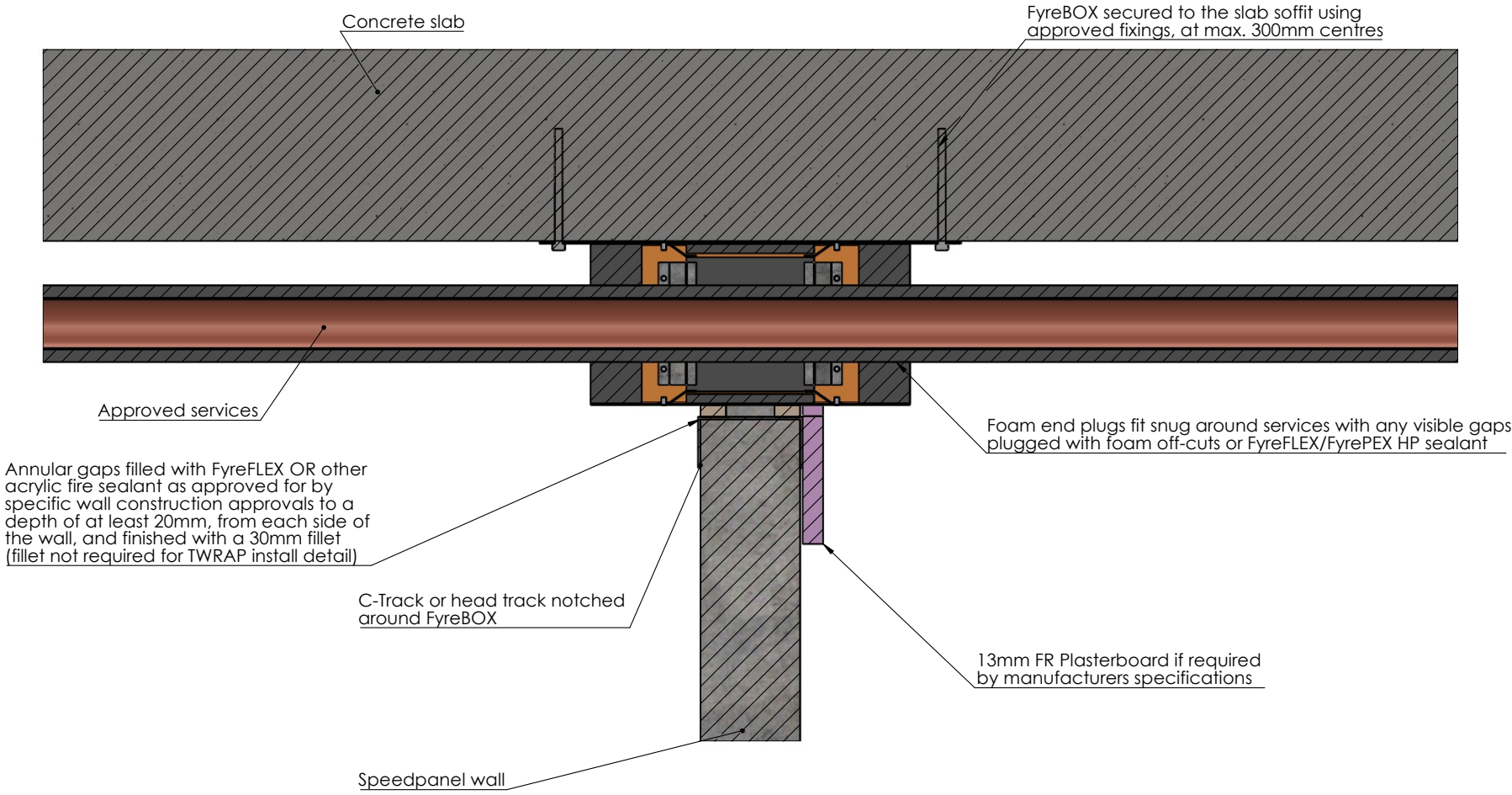

<b>Drawing Name:</b> SpeedPanel			<b>Test Standard:</b> AS1530.4	<b>Codes:</b>	<b>Revision:</b>	<b>Date:</b>	<b>No.:</b>	<b>NOTICE:</b>
<b>Project Title:</b> FyreBOX Slab-Mount - Generic Install			<b>Fire resistance level:</b> SECTION T-T SCALE 1 : 3	<b>Drawn By:</b> JC	<small>NOTE: ALL DIMENSIONS ARE IN MILLIMETRES (mm)</small>			
<b>Drawing No. :</b> 10	<b>Sheet:</b> 10 of 19	<b>Date:</b> 27/05/2020	<b>Scale:</b> NTS	<b>Based on Report No.:</b>	<b>Checked By:</b> CT	<input type="checkbox"/> STANDARD DRAWING <input type="checkbox"/> PROJECT DRAWING		



## Concrete / Masonry Walls (with or without permanent formwork)

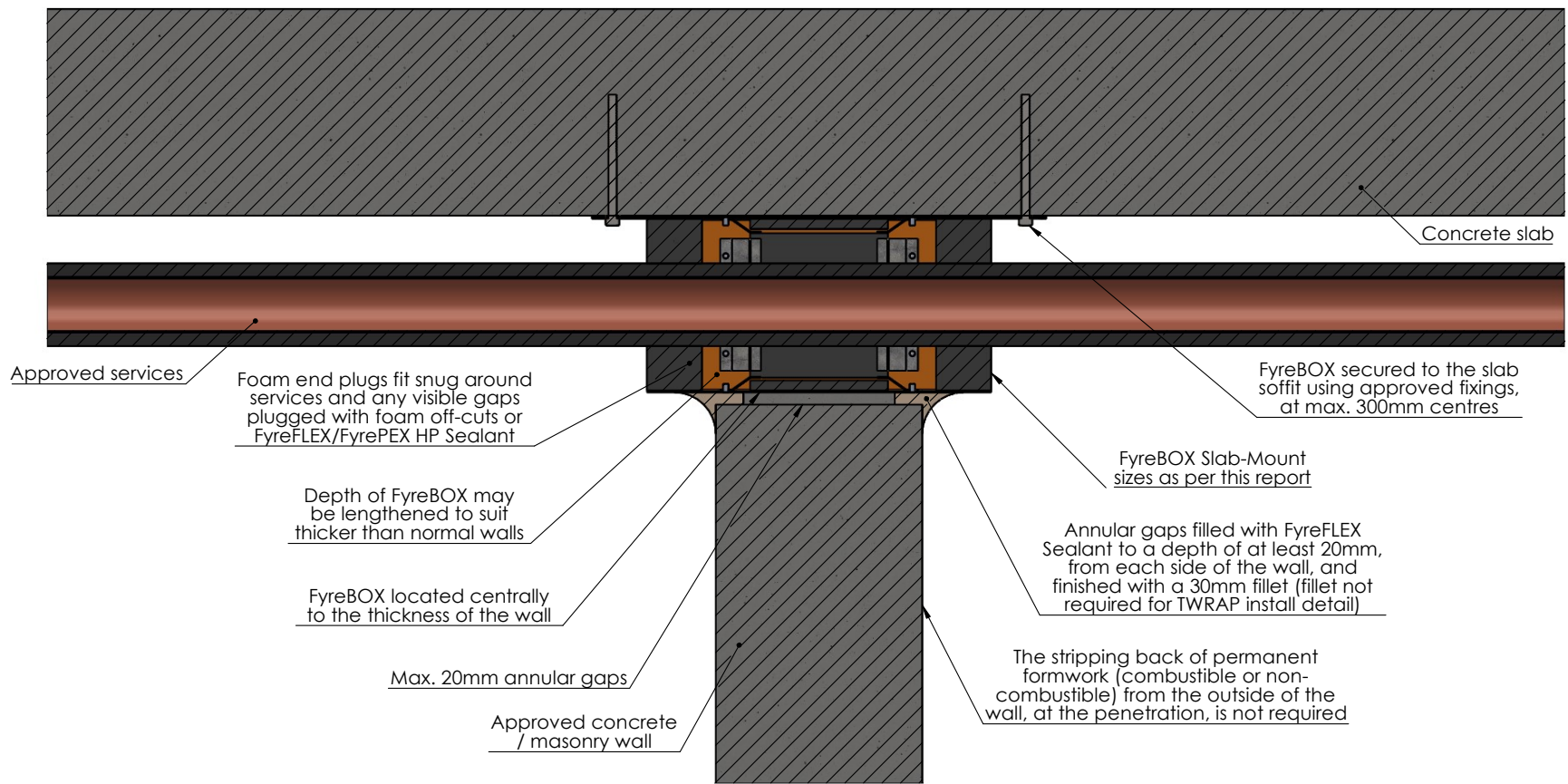

<b>Drawing Name:</b> Concrete / Masonry				<b>Test Standard:</b> AS1530.4	<b>Codes:</b>	<b>Revision:</b>	<b>Date:</b>	<b>No.:</b>	<b>NOTICE:</b>
<b>Project Title:</b> FyreBOX Slab-Mount - Generic Install				<b>Fire resistance level:</b>	<b>Drawn By:</b> JC				<small>NOTE: ALL DIMENSIONS ARE IN MILLIMETRES (mm)</small>
<b>Drawing No. :</b> 11	<b>Sheet:</b> 11 of 19	<b>Date:</b> 27/05/2020	<b>Scale:</b> NTS	<b>Based on Report No.:</b>	<b>Checked By:</b> CT	<input type="checkbox"/> STANDARD DRAWING <input type="checkbox"/> PROJECT DRAWING			



# FyreBOARD Maxilite

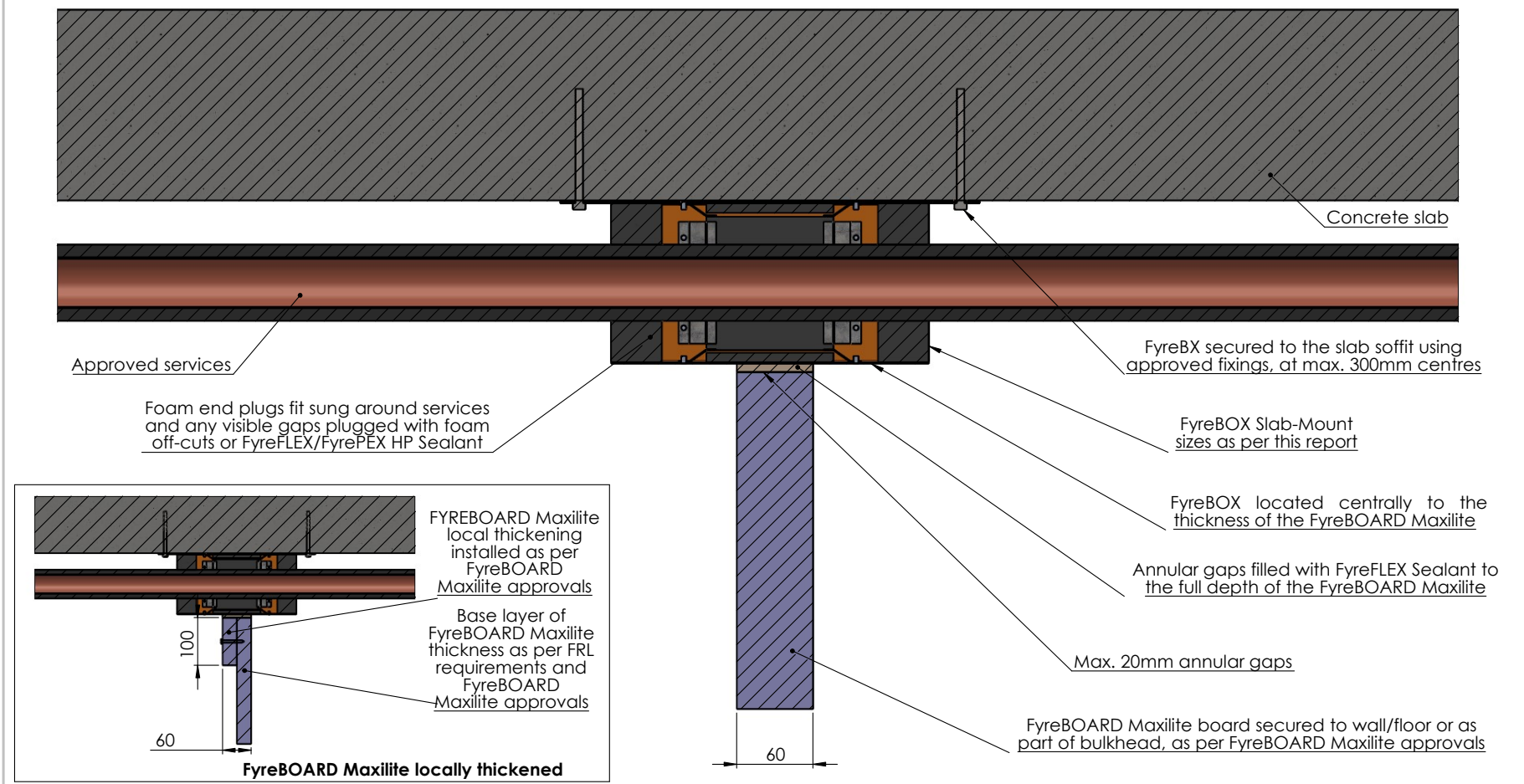

<b>Drawing Name:</b> FyreBOARD Maxilite				<b>Test Standard:</b> AS1530.4	<b>Codes:</b>	<b>Revision:</b>	<b>Date:</b>	<b>No.:</b>	<b>NOTICE:</b>
<b>Project Title:</b> FyreBOX Slab-Mount - Generic Install				<b>Fire resistance level:</b>	<b>Drawn By:</b> JC	<small>NOTE: ALL DIMENSIONS ARE IN MILLIMETRES (mm)</small> 			
<b>Drawing No. :</b> 12	<b>Sheet:</b> 12 of 19	<b>Date:</b> 27/05/2020	<b>Scale:</b> NTS	<b>Based on Report No.:</b>	<b>Checked By:</b> CT				

## TWRAP - Services Wrap

Where the FyreBOX configuration doesn't achieve full insulation in a given fire barrier, TWRAP can be applied to individual or groups of services in order to increase their insulation rating up to -/XXX/120, as required.

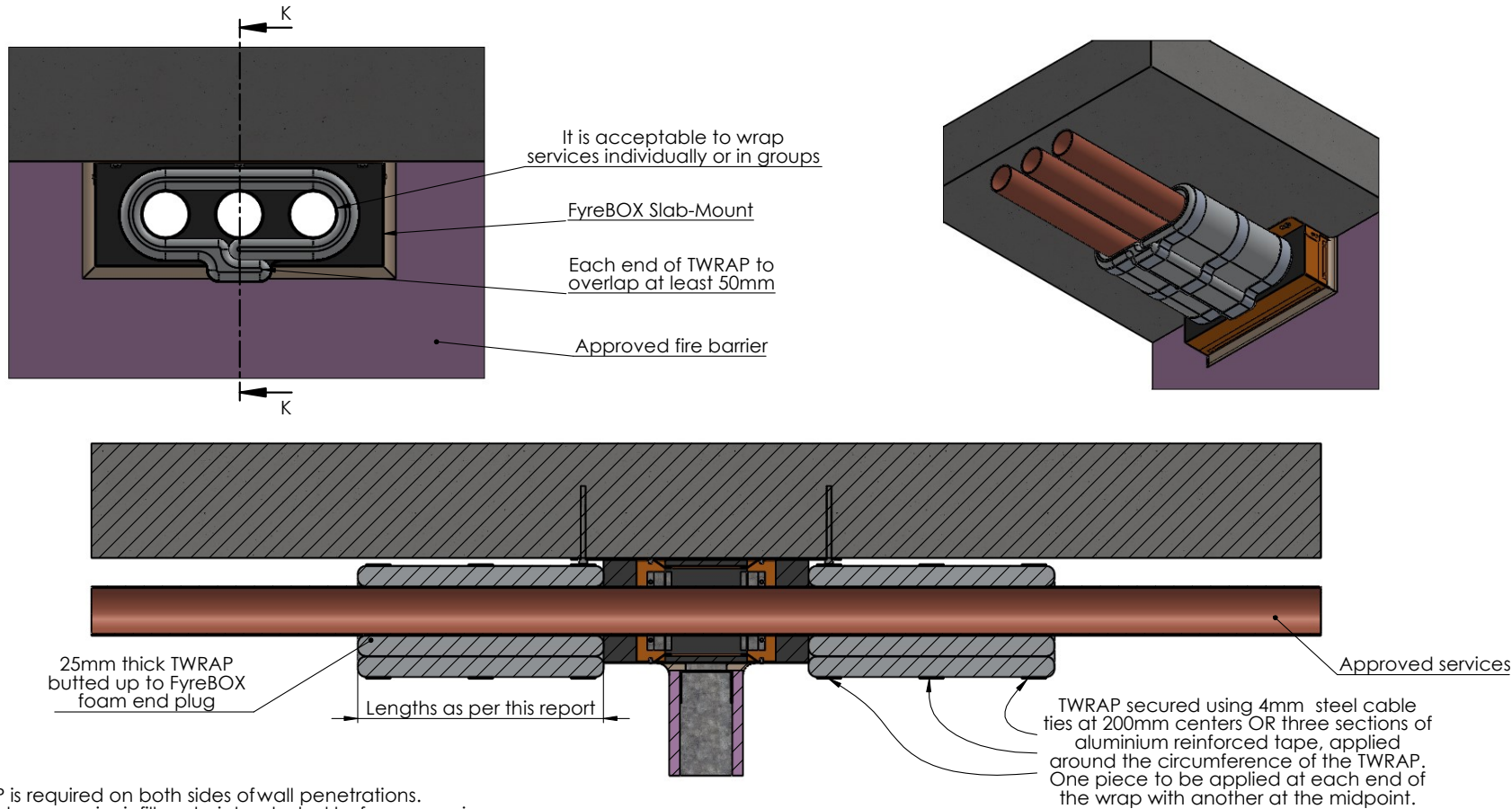

**NOTES:**

- TWRAP is required on both sides of wall penetrations.
- Cable trays require infill material as-tested before wrapping

<b>Drawing Name:</b> TWRAP - Services Wrap				<b>Test Standard:</b> AS1530.4	<b>Codes:</b>	<b>Revision:</b>	<b>Date:</b>	<b>No.:</b>	<b>NOTICE:</b>
<b>Project Title:</b> FyreBOX Slab-Mount - Generic Install				<b>Fire resistance level:</b>	<b>Drawn By:</b> JC				<small>NOTE: ALL DIMENSIONS ARE IN MILLIMETRES (mm)</small>
<b>Drawing No. :</b> 13	<b>Sheet:</b> 13 of 19	<b>Date:</b> 27/05/2020	<b>Scale:</b> NTS	<b>Based on Report No.:</b>	<b>Checked By:</b> CT	<input type="checkbox"/> STANDARD DRAWING <input type="checkbox"/> PROJECT DRAWING			





## TWRAP - 3-Sided Wrap

Where the FyreBOX configuration does not achieve full insulation in a given fire barrier, TWRAP will need to be applied to the FyreBOX casing and services in order to increase their insulation rating up to -/XXX/120.

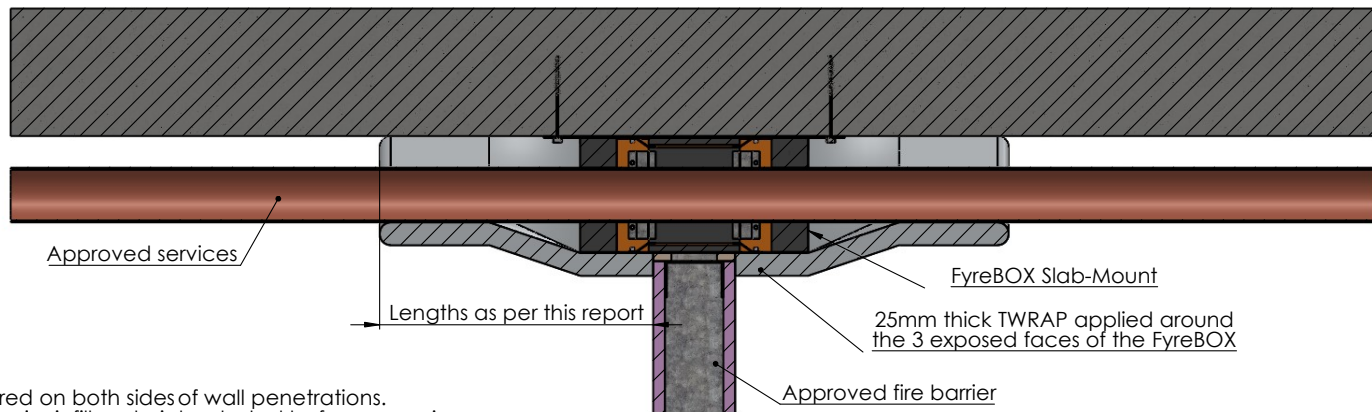
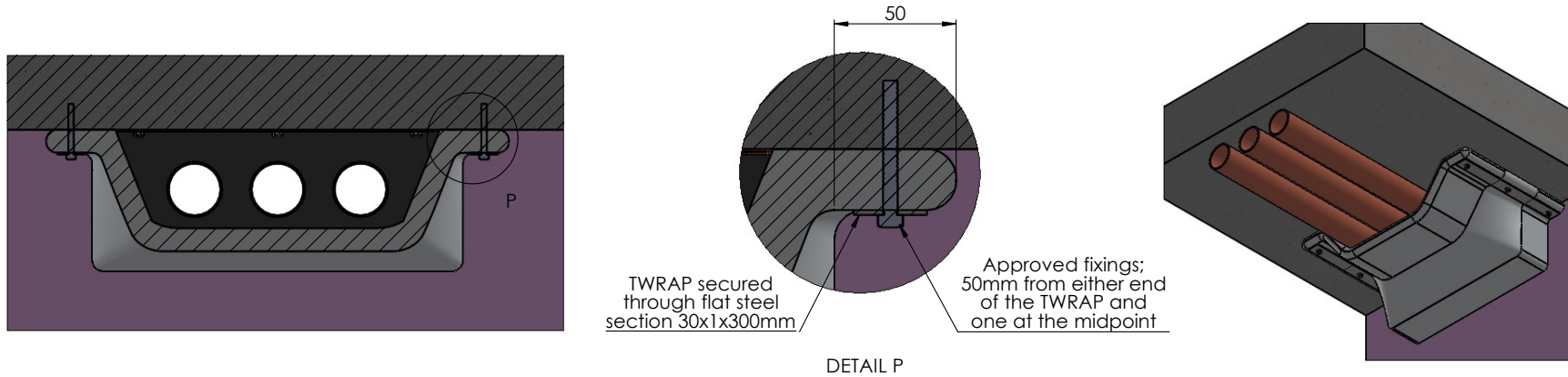

- NOTES:**
- TWRAP is required on both sides of wall penetrations.
  - Cable trays require infill material as-tested before wrapping

<b>Drawing Name:</b> TWRAP - 3-Sided Wrap				<b>Test Standard:</b> AS1530.4	<b>Codes:</b>	<b>Revision:</b>	<b>Date:</b>	<b>No.:</b>	<b>NOTICE:</b> <small>NOTE: ALL DIMENSIONS ARE IN MILLIMETRES (mm)</small>
<b>Project Title:</b> FyreBOX Slab-Mount - Generic Install				<b>Fire resistance level:</b>	<b>Drawn By:</b> JC				
<b>Drawing No. :</b> 14	<b>Sheet:</b> 14 of 19	<b>Date:</b> 27/05/2020	<b>Scale:</b> NTS	<b>Based on Report No.:</b>	<b>Checked By:</b> CT	<input type="checkbox"/> STANDARD DRAWING <input type="checkbox"/> PROJECT DRAWING			

### TWRAP - Stacked (Vertical)

- TWRAP detail required on each side of wall penetrations

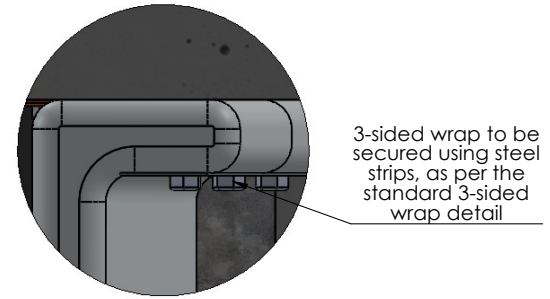
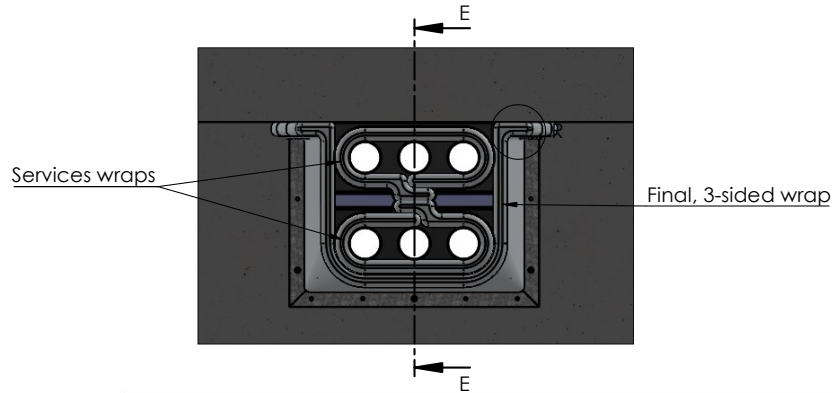

DETAIL R

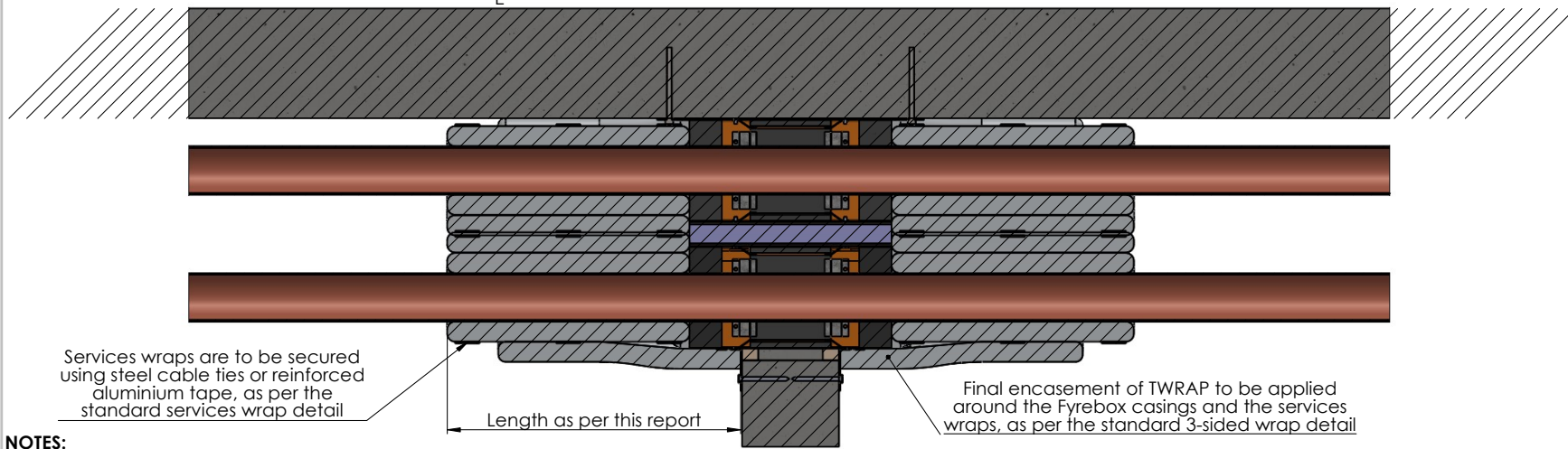

**NOTES:**

- TWRAP is required on both sides of wall penetrations.
- Cable trays require infill material as-tested before wrapping

<b>Drawing Name:</b> Stacked (Vertical) - TWRAP				<b>Test Standard:</b> AS1530.4	<b>Codes:</b>	<b>Revision:</b>	<b>Date:</b>	<b>No.:</b>	<b>NOTICE:</b>
<b>Project Title:</b> FyreBOX™ Slab-Mount - Generic Install				<b>Fire resistance level:</b>	<b>Drawn By:</b> JC	<small>NOTE: ALL DIMENSIONS ARE IN MILLIMETRES (mm)</small>  <b>Trafalgar Head Office:</b> PO BOX 545 Chester Hill NSW 2162 T: 1800 888 714 F: 1800 201 500 E: info@tfire.com.au W: www.tfire.com.au			
<b>Drawing No. :</b> 18	<b>Sheet:</b> 18 of 19	<b>Date:</b> 27/05/2020	<b>Scale:</b> NTS	<b>Based on Report No.:</b>	<b>Checked By:</b> CT				

## TWRAP - Stacked (Horizontal)

- TWRAP detail required on each side of wall penetrations and top side of floors

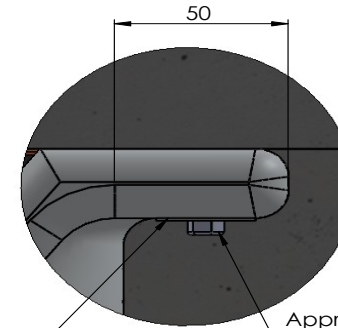
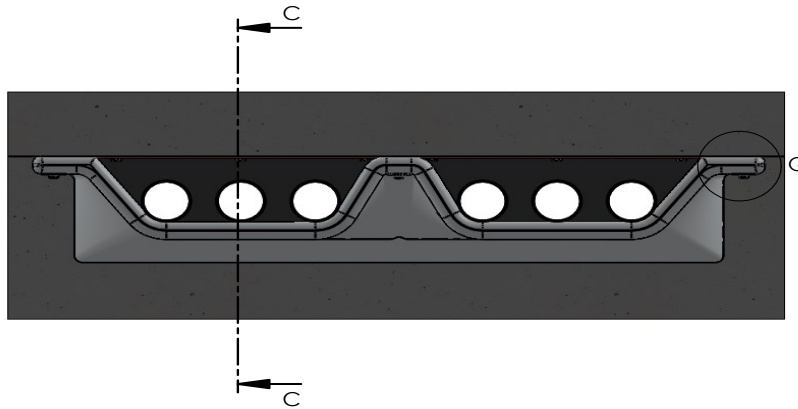

TWRAP secured through flat steel section 30x1x300mm

Approved fixings: 50mm from either end of the TWRAP and one at the midpoint

DETAIL Q

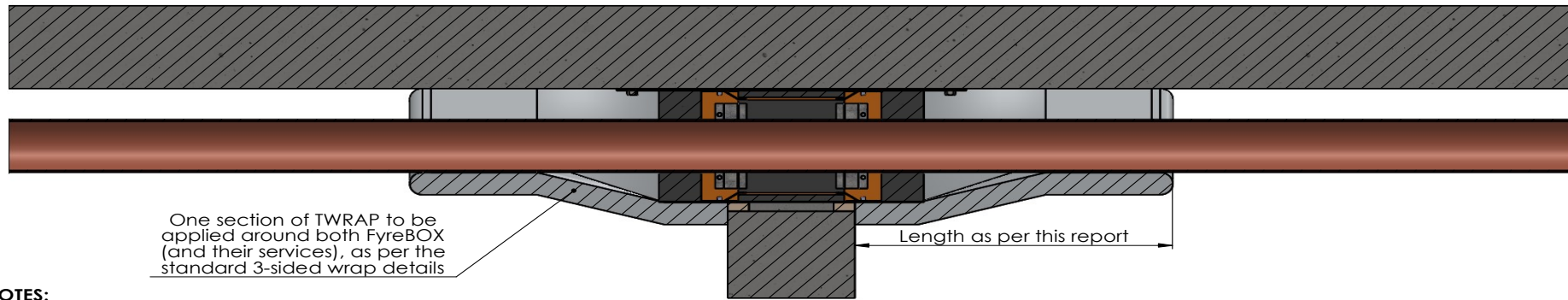

One section of TWRAP to be applied around both FyreBOX (and their services), as per the standard 3-sided wrap details

Length as per this report

**NOTES:**

- TWRAP is required on both sides of wall penetrations.
- Cable trays require infill material as-tested before wrapping

<b>Drawing Name:</b> Stacked (Horizontal) - TWRAP				<b>Test Standard:</b> AS1530.4	<b>Codes:</b>	<b>Revision:</b>	<b>Date:</b>	<b>No.:</b>	<b>NOTICE:</b>
<b>Project Title:</b> FyreBOX Slab-Mount - Generic Install				<b>Fire resistance level:</b>	<b>Drawn By:</b> JC				<small>NOTE: ALL DIMENSIONS ARE IN MILLIMETRES (mm)</small>  <b>Trafalgar Head Office:</b> PO BOX 545 Chester Hill NSW 2162 T: 1800 888 714 F: 1800 201 500 E: info@tfire.com.au W: www.tfire.com.au
<b>Drawing No. :</b> 17	<b>Sheet:</b> 17 of 19	<b>Date:</b> 27/05/2020	<b>Scale:</b> NTS	<b>Based on Report No.:</b>	<b>Checked By:</b> CT	<input type="checkbox"/> STANDARD DRAWING <input type="checkbox"/> PROJECT DRAWING			

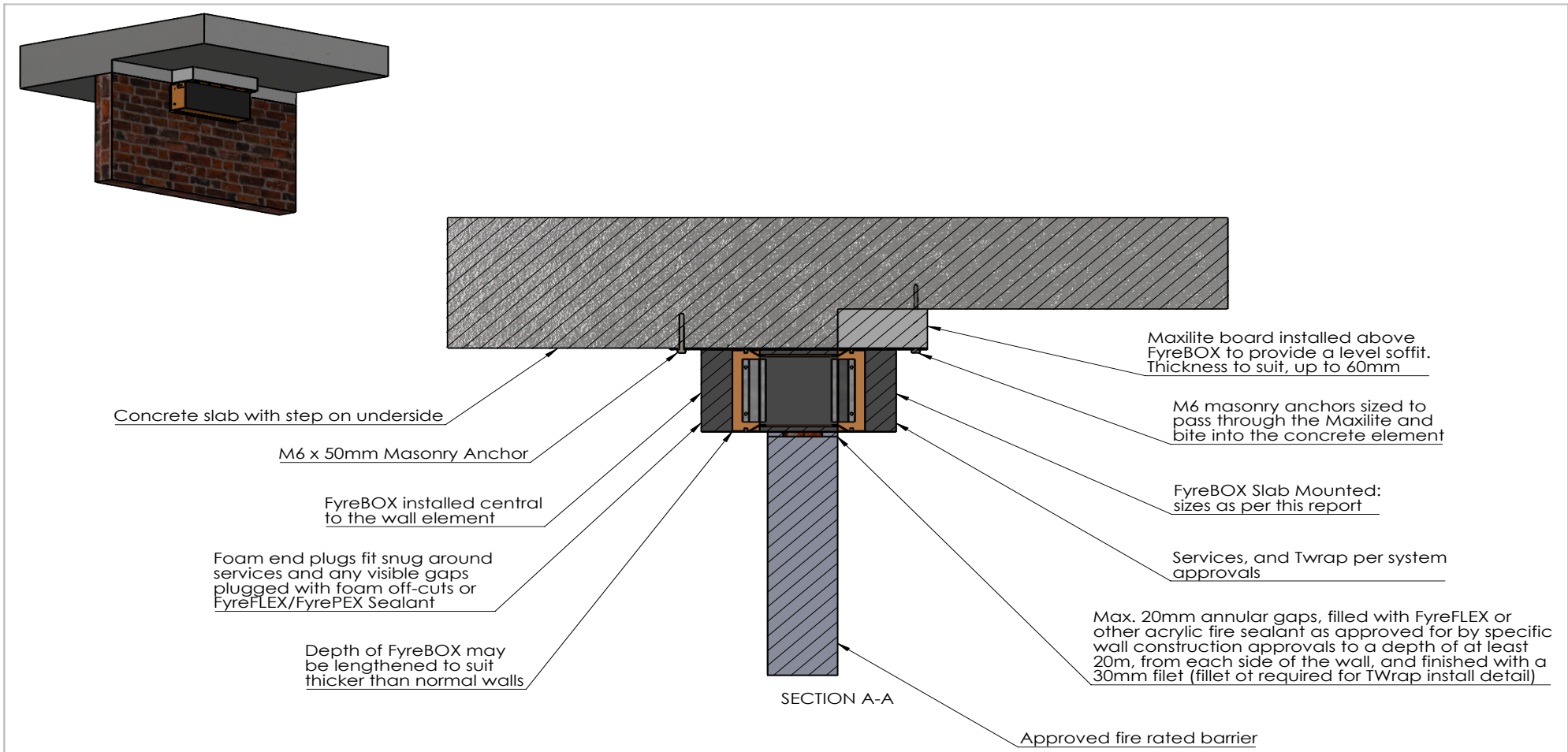

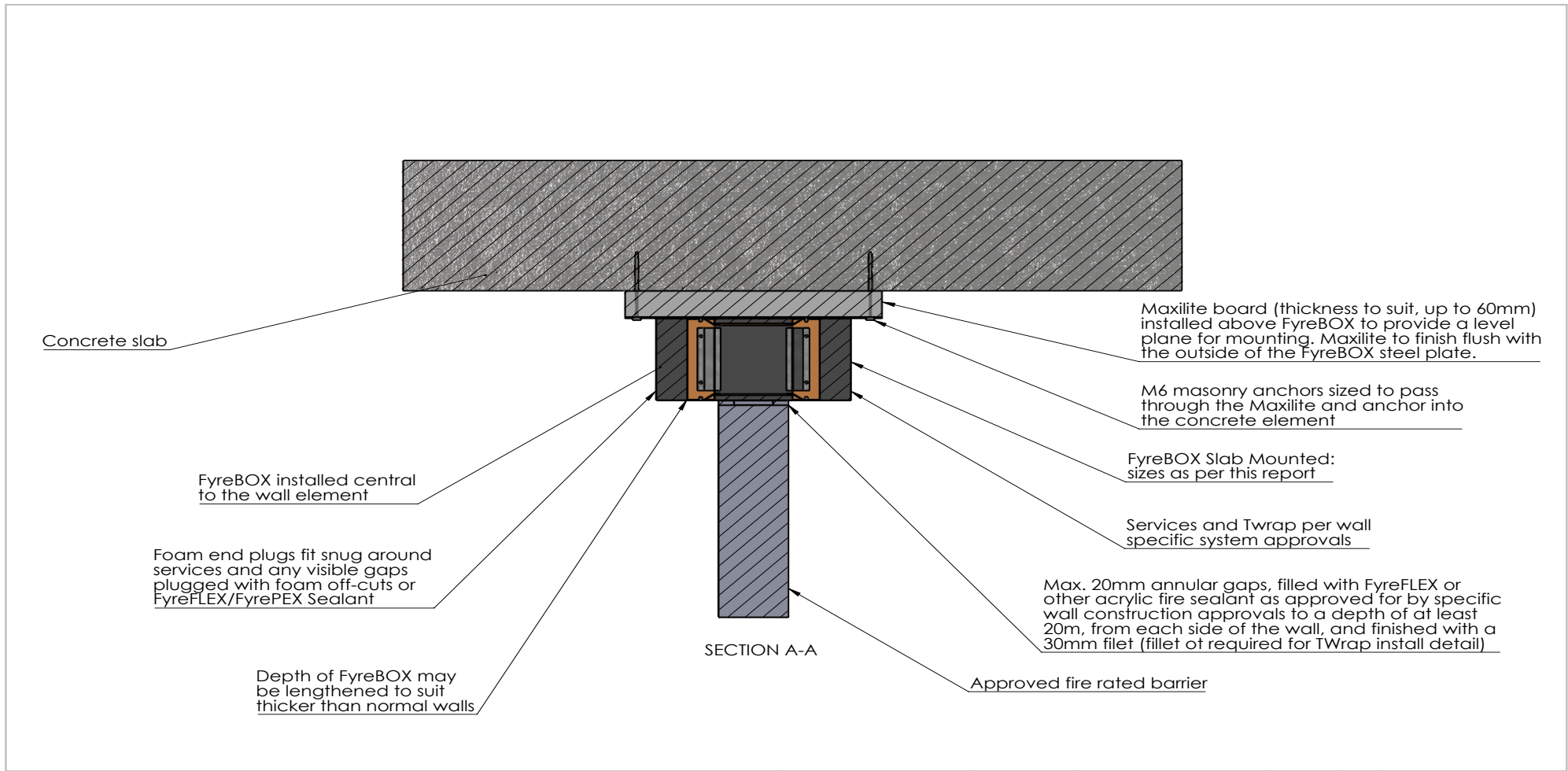

<b>Drawing Name:</b> Stepped Slabs				<b>Test Standard:</b> AS1530.4	<b>Codes:</b>	<b>Revision:</b>	<b>Date:</b>	<b>No.:</b>	<b>NOTICE:</b>
<b>Project Title:</b> FyreBOX Slab Mount - Generic				<b>Fire resistance level:</b>	<b>Drawn By:</b> SM	<small>NOTE: ALL DIMENSIONS ARE IN MILLIMETRES (mm)</small>			
<b>Drawing No. :</b> 1	<b>Sheet:</b> 1 of 1	<b>Date:</b> 1/07/2022	<b>Scale:</b> NTS	<b>Based on Report No.:</b>	<b>Checked By:</b> JH	<input type="checkbox"/> STANDARD DRAWING	 <p><b>TRAFALGAR FIRE</b> PO BOX 545 Chester Hill NSW 2162 T: 1800 888 714 F: 1800 201 500 E: technical@tgroup.com.au W: www.tfire.com.au</p>		
						<input type="checkbox"/> PROJECT DRAWING			



<b>Drawing Name:</b> Oversized Penetration - Height				<b>Test Standard:</b> AS1530.4	<b>Codes:</b>	<b>Revision:</b>	<b>Date:</b>	<b>No.:</b>	<b>NOTICE:</b>
<b>Project Title:</b> FyreBOX Slab Mounted - Generic Install				<b>Fire resistance level:</b>	<b>Drawn By:</b> SM	<small>NOTE: ALL DIMENSIONS ARE IN MILLIMETRES (mm)</small>			
<b>Drawing No. :</b> 1	<b>Sheet:</b> 1 of 2	<b>Date:</b> 11/08/2022	<b>Scale:</b> NTS	<b>Based on Report No.:</b>	<b>Checked By:</b> JH	<input type="checkbox"/> STANDARD DRAWING	 <p><b>TRAFALGAR FIRE</b>                  PO BOX 545                  Chester Hill NSW 2162                  T: 1800 888 714                  F: 1800 201 500                  E: technical@tgroup.com.au                  W: www.tfire.com.au</p>		
						<input type="checkbox"/> PROJECT DRAWING			

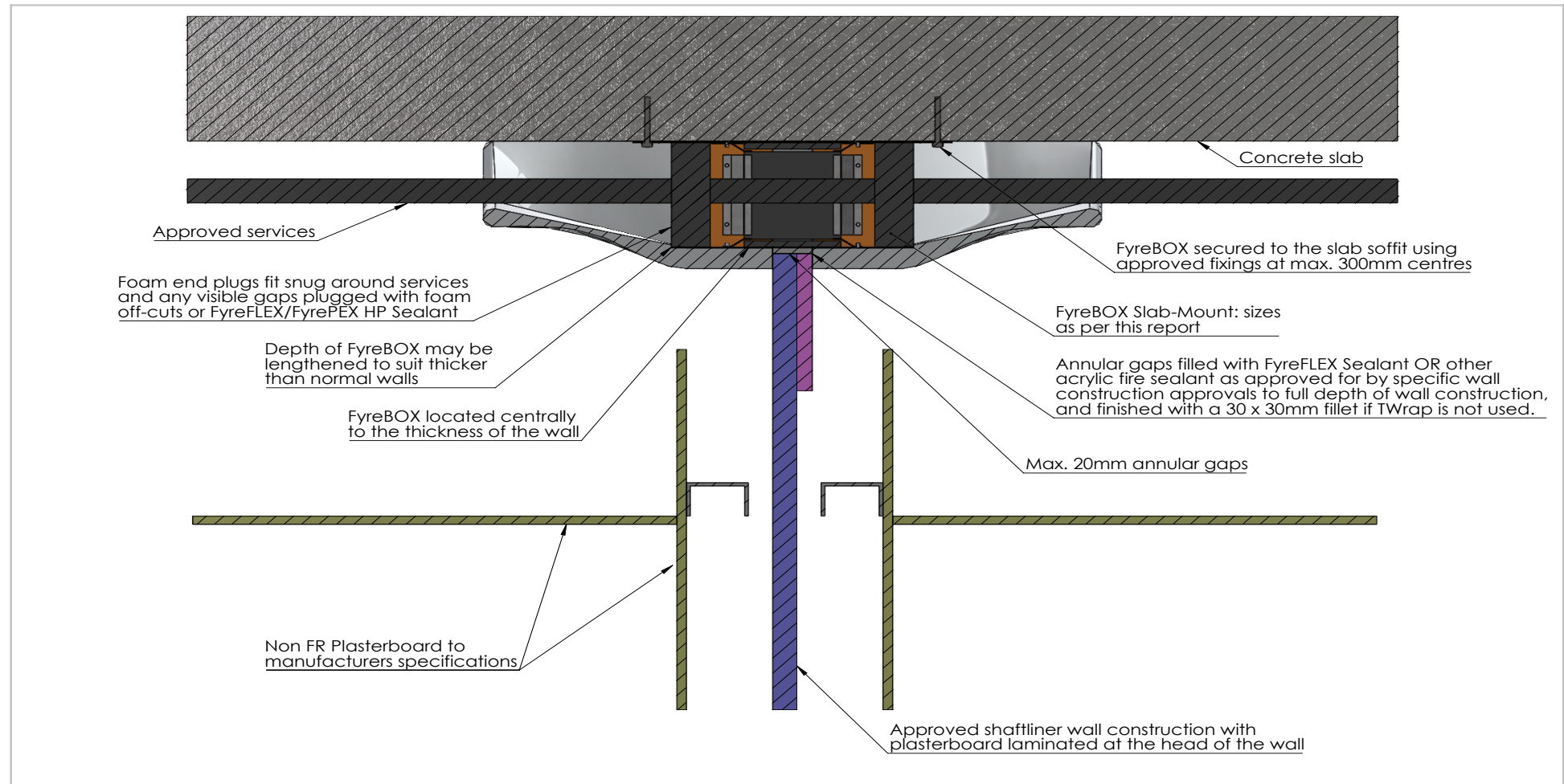



<b>Drawing Name:</b> Head of Party Wall Penetration				<b>Test Standard:</b> AS1530.4	<b>Codes:</b>	<b>Revision:</b>	<b>Date:</b>	<b>No.:</b>	<b>NOTICE:</b>
<b>Project Title:</b> FyreBOX Slab-Mounted - Generic Install				<b>Fire resistance level:</b>	<b>Drawn By:</b> SM	<small>NOTE: ALL DIMENSIONS ARE IN MILLIMETRES (mm)</small>			
<b>Drawing No. :</b> 1	<b>Sheet:</b> 1 of 1	<b>Date:</b> 26/08/2022	<b>Scale:</b> NTS	<b>Based on Report No.:</b>	<b>Checked By:</b> JH	<input type="checkbox"/> STANDARD DRAWING	 <p><b>TRAFALGAR FIRE</b>                  PO BOX 545                  Chester Hill NSW 2162                  T: 1800 888 714                  F: 1800 201 500                  E: technical@tgroup.com.au                  W: www.tfire.com.au</p>		
						<input type="checkbox"/> PROJECT DRAWING			