

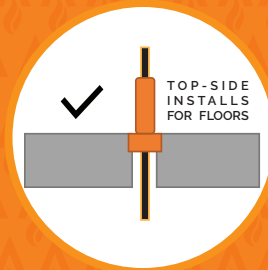

SEALANT GUIDE FOR PLUMBERS

FyrePEX™ HP



FyrePEX™ High-Performance Sealant is a graphite water-based intumescent mastic sealant that is used for fire stopping of service penetrations through fire-rated walls and floors to prevent the spread of fire for up to 2 hours.

Click To Watch:



KEY FEATURES



- Specifically designed for water and gas PEX pipe penetrations
- Also suitable for HVAC&R and electrical services
- Quick and easy to apply and install
- FyreSHEATH option helps reduce wastage
- Tested for all common wall and floor types
- Non-toxic & Green star rated for low VOC
- Water based for easy clean up
- Fire tested and approved in accordance with AS1530.4-2014 and AS4072.1

APPLICATIONS



- PEX pipes
- PEX-AL-PEX pipes
- Insulated steel and copper

Plumbers

This manual specifically covers plumbing service penetrations. For details on electrician or HVAC&R service penetrations with FyrePEX HP® sealant, visit: <https://tfire.com.au/product/fyrepex-hp-fire-rated-sealant/>

FyreSHEATH

FyreSHEATH is a system designed to simplify the use of FyrePEX™ High-Performance Sealant, ensuring a compliant amount of sealant everytime to achieve the FRL required up to a -/120/120, while minimising sealant waste from overfilling into the wall cavity and saving you money.



Click To Watch:



KEY FEATURES



- No need for plasterboard patching
- Hole size is no longer critical
- Sets the annular gaps and fill depths automatically
- Easy compliance checks for certification
- Improved quality control
- Suitable for single and double layer plaster walls
- Tested to AS1530.4-2014 and compliant with AS4072.1

APPLICATIONS



Plumbers

- PEX- A
- PEX- B
- PEX-AL-PEX pipes

TRADES

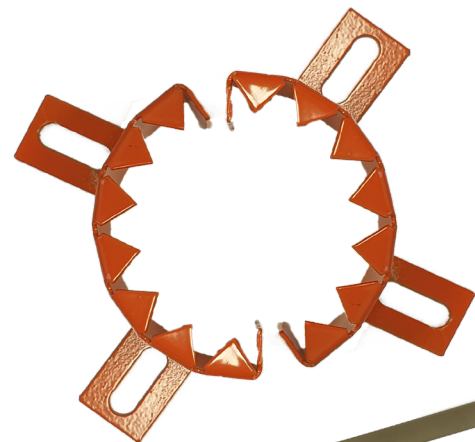

TABLE OF CONTENTS







Section	Page	
What is FyrePEX HP?	4	
Fire Resistance Level	5	
PRE-install notes	6	
FRL Tables	Plasterboard 60min	7
	Plasterboard 90min	8
	Plasterboard 120min	9
	Concrete / Masonry	10
	Hebel®	11
	Speedpanel®	12
	Prontopanel®	13
	Floor Slabs FyreBOARD Maxilite® Panel	13
Installation	Walls - Sealant Only	14
	Walls- FyreSHEATH	15
	Wall Specific - Single Layer Plasterboard	16
	Wall Specific - Double Layer Plasterboard	17
	Wall Specific - Concrete / Masonry	18
	Installation Hebel®, WALSC, Speedpanel & Pronto	19
	Concrete Floors	20
System Range	21	
FAQs	22	
Technical Drawing:Plastic or Insulated Pipe Penetration	23	

WHAT IS FYREPEX HP?



FyrePEX High-Performance (HP) Sealant is a graphite & water-based intumescent mastic/sealant that is used for fire protection of service penetrations through fire-rated walls and floors to prevent the spread of fire for up to 2 hours. This type of sealant is designed to expand with a high pressure to fill any gaps that form when plastic pipes and cables melt away and maintain the FRL of the wall or floor that they pass through.

Whilst it was first developed for plumbing services (hence the FyrePEX name!) this sealant has proven extremely useful when tested with a wide range of building services. This manual lists the plumbing services that can be sealed with FyrePEX HP, however you can click the icons below to find trade specific installation manuals:

Plumbing (See below manual)	Electrical and data 	HVAC&R 
PEX pipes PEX-AL-PEX pipes	Fire cable and data cable bundles Power cables (Al and Copper core) PVC conduits	Pair coil bundles Small CHW pipes
		

Key Features:

- Specifically designed for water and gas PEX pipe penetration seals
- Also suitable for electrical, data and HVAC&R services
- Quick and easy to apply and install
- Tested for SpeedPanel, Hebel, Walsc, Maxilite and plasterboard walls
- Non-toxic fire-rated mastic
- Green star rated for low VOC
- Water based fire mastic for easy clean up
- Tested and approved in accordance with AS1530.4-2014 and AS4072.1
- FyrePEX HP Fire-rated mastic compliance made easy with FyreSHEATH
- Head of wall penetrations now approved when using the [FyreSTRAP systems](#)

Please check the product approvals listed below and in the FyrePEX HP fire assessment report FAR 4849 before use on your project. For test reports, installation videos and more please visit www.tfire.com.au.

FyrePEXTM HP

FIRE RATING – HOW IS FIRE PERFORMANCE MEASURED?

An FRL (fire resistance level) is a handy way of summarising the performance of a building element. It consists of 3 numbers, all given in minutes:

FRL 120/120/120

(example)



Structural Adequacy

The ability of the building element to support the weight of adjacent building elements.

ie: a brick wall supporting a concrete floor slab above.



Integrity

The ability of an element to prevent the passage of flames and hot gasses.

ie: a plasterboard wall remaining intact and not allowing holes to form.

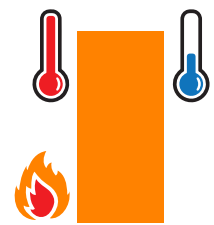

Insulation

The ability of an element to resist heat transfer from the exposed face to the unexposed face.

ie: a bundle of cables remaining below a set temperature limit on the unexposed side of the wall penetration system.

Note: Penetrations are not required to have a Structural Adequacy rating and is usually expressed as a dash. For example, a penetration through a 2 hour load bearing wall would be written as -/120/120.

INTEGRITY

The FyrePEXTM HP Sealant system will achieve the integrity performance for up to 2 hours physically stopping the direct spread of fire, however the insulation performance of the penetration will be limited to the type of wall being used and conductivity of the services in the penetration.

INSULATION (TEMPERATURE RISE)

Heat transfer via conduction (or heat rise) will occur through the conductive parts of any penetration system. To limit the heat rise through some of the FyrePEXTM HP Sealant penetration systems, our 25mm thick TWRAPTM foil encased blanket can be wrapped around the services to achieve up to 2 hours of insulation performance. There are some applications that won't require any TWRAPTM to achieve the full FRL, please refer to the tables below for specific details.

PRE-INSTALL NOTES

ANNULAR GAP

The annular gap is the space between a service and the hole. Annular gaps are important as they allow for movement in the building and service.

FyrePEX® HP sealant is used in the annular gap to form a seal to stop the spread of fire formed by plastic pipes, lagged pipes and cables when they melt away. The approved annular gap for this sealant is 10-20mm, depending on application.

If an opening has already been formed and it is larger than what is prescribed here in this manual, Trafalgar Fire has several systems that can be used to close down the opening to the correct size:

- FyreBATT
- FyreBOARD Maxilite®
- FyreBOX range

Refer to your preferred system technical manual for details on installation and approved barriers and services or, contact Trafalgar Fire at technical@tgroup.com.au for technical assistance.



SERVICE SEPARATION

The distance between any two services can be a tricky topic of conversation. There are trade specific requirements (i.e. proximity of electrical services to gas services), but often asked is what are the requirements for compliance with fire stopping systems? FyrePEX® HP Sealant is approved to have penetrations as close as 50mm away from one another (i.e. 50mm between openings, edge-to-edge).

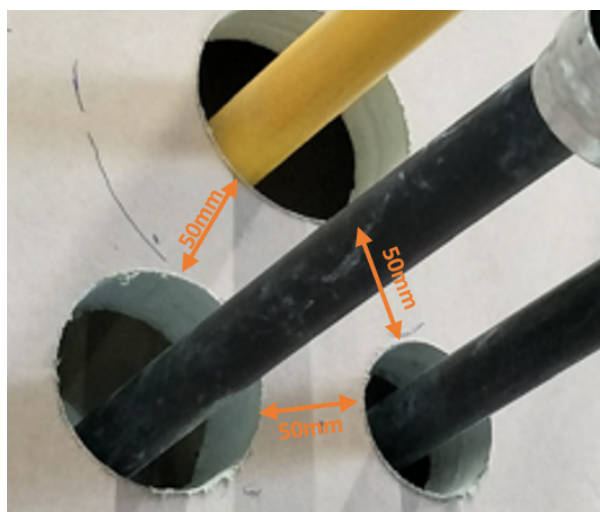

PLASTERBOARD 60MIN

Single-Layer plasterboard walls
min 13mm FR plasterboard each
side **64mm Stud systems**

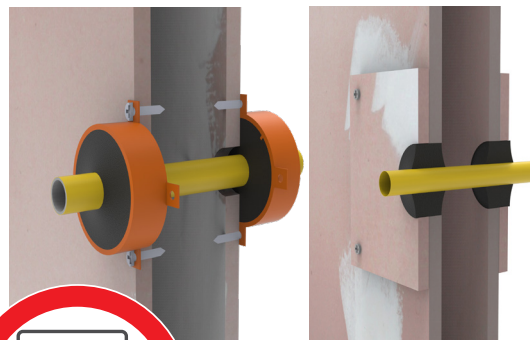

Service Specification		Installation Method	Hole Size	Fill Depth	FRL	Report Reference
PEX-A PEX-B PEX-AL-PEX	16mm	Locally Thickened Wall Fill (each side of wall)	60mm	Depth of plaster (26mm)	-/60/60	FAR 4849
		50mm diam. Sheath Fill (each side of wall)	25mm	Depth of sheath (25mm)		
PEX-A PEX-B PEX-AL-PEX	20mm	Locally Thickened Wall Fill (each side of wall)	60mm	Depth of plaster (26mm)		
		65mm diam. Sheath Fill (each side of wall)	25mm	Depth of sheath (25mm)		
PEX-A PEX-B PEX-AL-PEX	20mm (half wall)	Locally Thickened Wall Fill (one side of wall thickened)	60mm	Depth of plaster and patch, finished with 30mm fillet*		FAS220102
PEX-A PEX-B	25mm	Locally Thickened Wall Fill (each side of wall)	65mm	Depth of plaster (26mm)		FAR 4849
PEX-AL-PEX	25mm	Locally Thickened Wall Fill (each side of wall)	65mm	Depth of plaster (26mm) Sealant finished with 25mm fillet		

* Half wall system- Service entering and exiting the same side of the wall. Wall **stud required to be min. 92mm**. Refer to drawing page 21

Half Wall System

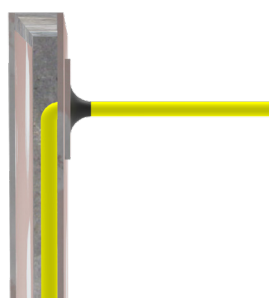

PLASTERBOARD 90MIN

Single-Layer plasterboard walls with additional second layer fixed around the penetration
64mm Stud systems

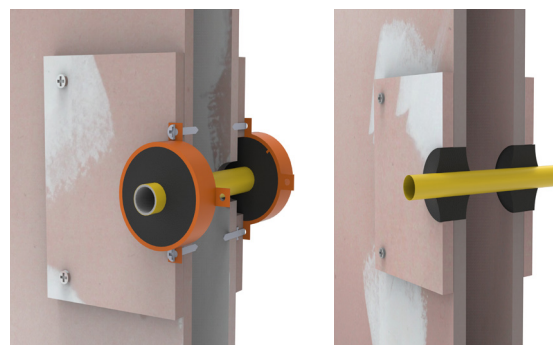

Service Specification		Installation Method	Hole Size	Fill Depth	FRL	Report Reference
PEX-A PEX-B PEX-AL-PEX	16mm	Locally Thickened Wall Fill (each side of wall)	60mm	Depth of plaster (26mm)	-/90/90	FAR 4849
		50mm diam. Sheath Fill (each side of wall)	25mm	Depth of sheath (25mm)		
PEX-A PEX-B PEX-AL-PEX	20mm	Locally Thickened Wall Fill (each side of wall)	60mm	Depth of plaster (26mm)		
		65mm diam. Sheath Fill (each side of wall)	30mm	Depth of sheath (25mm)		
PEX-A PEX-B	25mm	Locally Thickened Wall Fill (each side of wall)	65mm	Depth of plaster (26mm)		
PEX-AL-PEX	25mm	Locally Thickened Wall Fill (each side of wall)	65mm	Depth of plaster (26mm) Sealant finished with 25mm fillet		

PLASTERBOARD 120MIN

Double-Layer plasterboard walls
min 13mm FR plasterboard each
side **64mm Stud systems**

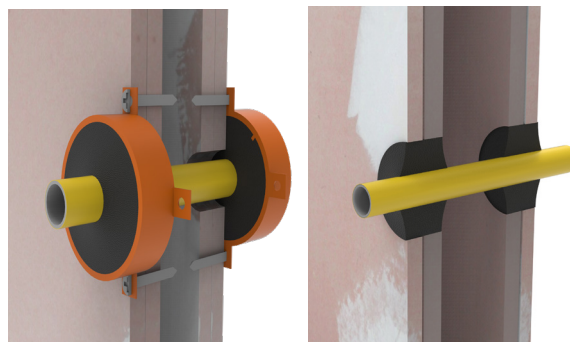

Service Specification		Installation Method	Hole Size	Fill Depth	FRL	Report Reference
PEX-A PEX-B PEX-AL-PEX	16mm	Wall Fill (each side of wall)	60mm	Depth of plaster (26mm)	-/120/120	FAR 4849
		50mm diam. Sheath Fill (each side of wall)	25mm	Depth of sheath (25mm)		
PEX-A PEX-B PEX-AL-PEX	20mm	Wall Fill (each side of wall)	60mm	Depth of plaster (26mm)		
		65mm diam. Sheath Fill (each side of wall)	30mm	Depth of sheath (25mm)		
PEX-A PEX-B	25mm	Wall Fill (each side of wall)	65mm	Depth of plaster (26mm)		
PEX-AL-PEX	25mm	Wall Fill (each side of wall)	65mm	Depth of plaster (26mm) Sealant finished with 25mm fillet		

CONCRETE/MASONRY

Minimum 116mm thick
Constructed as per
AS3600 and AS3700

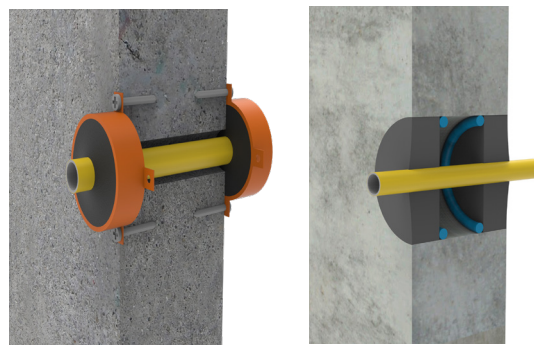

Service Specification		Installation Method	Hole Size	Fill Depth	FRL	Report Reference
PEX-A PEX-B PEX-AL-PEX	16mm	Wall Fill (each side of wall)	60mm	26mm Both sides of wall	-/120/120	FAR 4849
		50mm diam. Sheath Fill (each side of wall)	25mm	Depth of sheath (25mm)		
PEX-A PEX-B PEX-AL-PEX	20mm	Wall Fill (each side of wall)	60mm	26mm Both sides of wall		
		65mm diam. Sheath Fill (each side of wall)	30mm	Depth of sheath (25mm)		
PEX-A PEX-B	25mm	Wall Fill (each side of wall)	65mm	26mm Both sides of wall		
PEX-AL-PEX	25mm	Wall Fill (each side of wall)	65mm	26mm Both sides of wall Sealant finished with 25mm fillet		

Hebel®

AAC Panel and Wasc Wall Systems Minimum 75mm Thickness

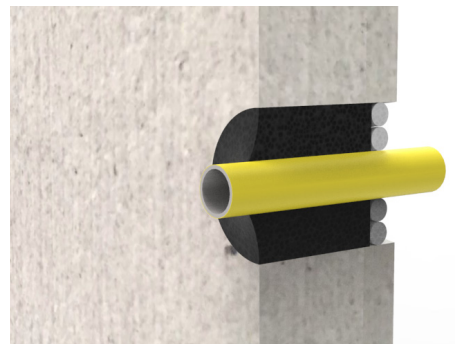

Service Specification		Installation Method	Hole Size	Fill Depth	FRL	Report Reference
PEX-A PEX-B PEX-AL-PEX	16mm	Wall Fill (one side of wall only)	40mm	60mm	-/90/90	FAR 4849
PEX-A PEX-B PEX-AL-PEX	20mm	Wall Fill (one side of wall only)	50-60mm	60mm		
		Wall Fill* (both sides of the wall)	33mm	60mm		
PEX-A PEX-B	25mm	Wall Fill (one side of wall only)	65mm	60mm		
PEX-AL-PEX	25mm	Wall Fill (25mm both side of wall)	67mm	25mm Sealant finished with 25mm fillet		

Note: One sided install provides 2-way FRL

* 33mm diameter opening, fitted with a 25mm deep by 50/60 mm diameter FyrePEX FyreSHEATH fixed to each side of the wall filled with FyrePEX sealant.

Speedpanel®

Speedpanel® Walls Minimum 78mm Thickness

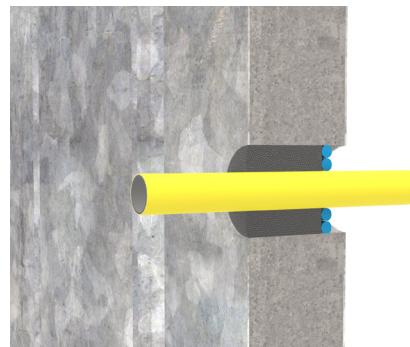

Service Specification		Installation Method	Hole Size	Fill Depth	FRL	Report Reference
PEX-A PEX-B	16mm	Wall Fill (one side of only)	40mm	60mm	-/120/120	FAR 4849
PEX-AL-PEX	16mm	Wall Fill (one side of only with 10x10mm fillet)	40mm	78mm		
PEX-A PEX-B	20mm	Wall Fill (one side of only with 10x10mm fillet)	50-60mm	60mm		
PEX-AL-PEX	20mm	Wall Fill (full depth with 10x10mm fillet)	50-60mm	78mm		

Note: One sided install provides 2-way FRL

PRONTO PANEL

Minimum 60mm thick panel



Service Specification		Installation Method	Hole Size	Fill Depth	FRL	Report Reference
PEX-AL-PEX Pipe	20mm	50mm sheath fill (each side of wall)	33mm	Full depth of sheath	-/60/60	FAR 4849
PEX-A	20mm	Panel fill (with a 25x25mm fillet)	50mm	Full depth	-/60/60	

FLOOR SLABS

Minimum 120mm thick concrete slab
As per AS 3600

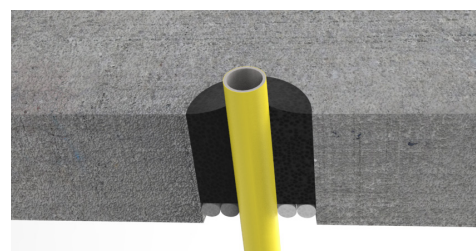

Service Specification		Installation Method	Hole Size	Fill Depth	FRL	Report Reference
PEX-B PEX-AL-PEX	16mm	Slab Fill (from one side only)	40mm	60mm	-/120/120	FAR 4849

FyreBOARD Maxilite® PANEL

60mm thick or two laminated boards 120mm thick

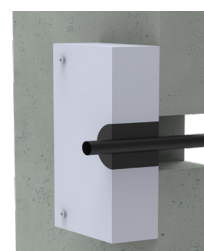

Service Specification		Installation Method	Hole Size	Fill Depth	FRL		Report Reference
					Maxilite Thickness		
					60mm	120mm	
PEX-B	16mm	Panel Fill	50-60mm	Full depth	-/120/60	-/120/90	FAR 4849
PEX-AL-PEX					-/120/120		
PEX-A or B	20mm	30mm diam. Sheath Fill (each side of wall)	30mm	Depth of sheath (25mm)	-/120/120	N/A	
PEX-AL-PEX					-/120/30	-/120/120	

INSTALLATION SEALANT ONLY

WALLS

FyrePEX™ HP Sealant can be applied directly into the thickness of a fire barrier to provide fire separation using the following installation method. Note that single layer plasterboard walls will require a second layer of plasterboard locally to the penetration.

CUT HOLES



Cut opening to suit the penetration size as per the tables in this product manual. Ensure that the services are run straight through the centre line of the opening and is free from movement.

CLEAN OPENINGS

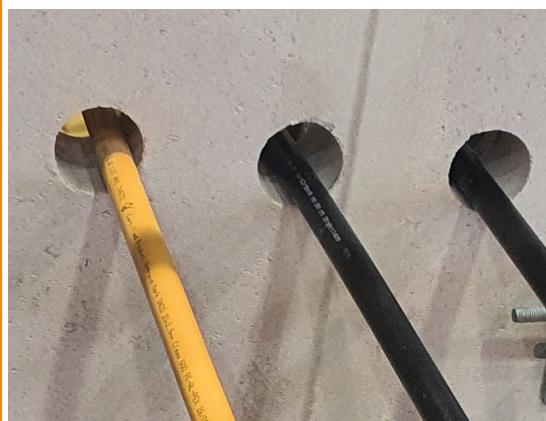

Surfaces to be sealed must be clean, dry and free from dust, dirt and grease. To achieve a clean finish, apply masking tape either side of the penetration to prevent sealant spreading onto unwanted areas.

FyrePEX™ HP SEALANT



Apply sealant with a standard applicator gun ensuring good surface contact is achieved by forcing sealant into the opening to be sealed. Ensure that the correct depth of sealant is applied as required for the specific installation - refer to tables on [pages 7-13](#) (foam or other backing rods can be used to achieve the correct depth if required).

FINISH



If necessary, tool within 5 minutes of application using a spatula dipped in soapy water, applying sufficient pressure to ensure good contact of the sealant against the joint surfaces. Remove masking tape. FyrePEX™ HP Sealant is easily cleaned off tools and hands with warm water.

INSTALLATION

FyreSHEATH

WALLS

FyreSHEATH system can be installed to the face of a fire wall on both sides as an alternative installation option. This reduces waste by preventing sealant overflow into the wall cavity, and controls the annular gap requirements ensuring compliance. Note that for single layer plasterboard walls, no local thickening is required.

PREPARE

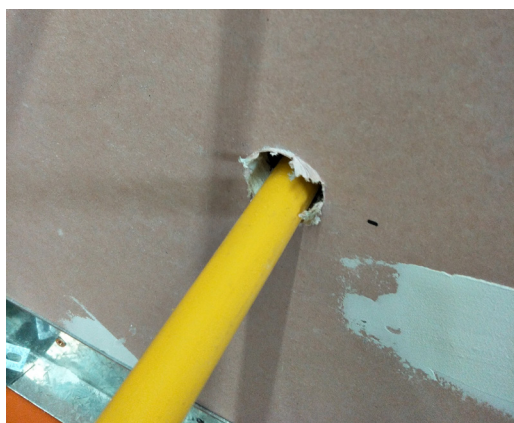

Cut opening to suit the penetration size as per the tables in this product manual. Ensure that the services are run straight through the centre line of the opening and is free from movement.

FIX

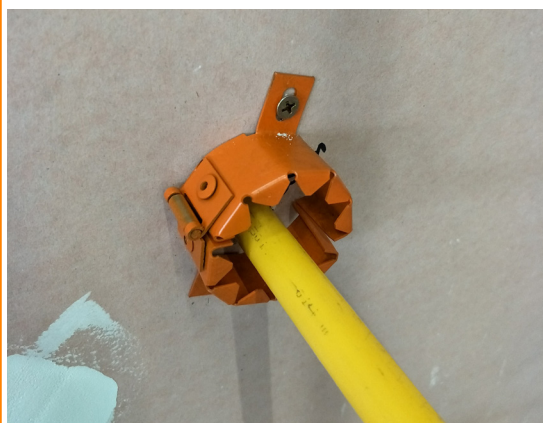

Fix the two halves of the metal FyreSHEATH around the pipe to both sides of the wall with 8g x 25mm plasterboard screws (or M6 masonry anchors into concrete barriers) using the pre-formed fixing tabs.

SECURE



Install a stainless steel cable tie around the outside perimeter of the FyreSHEATH and repeat on both sides of the wall.

FyrePEX™ HP SEALANT



Fill the FyrePEX™ HP sealant into the cavity formed with the FyreSHEATH to the full depth, finishing flush with the lip of the metal FyreSHEATH.

INSTALLATION WALL SPECIFIC

SINGLE LAYER PLASTERBOARD

Single layer plasterboard walls should use FyreSHEATH for PEX pipes, otherwise additional thicknesses of plasterboard is required locally around the penetration.

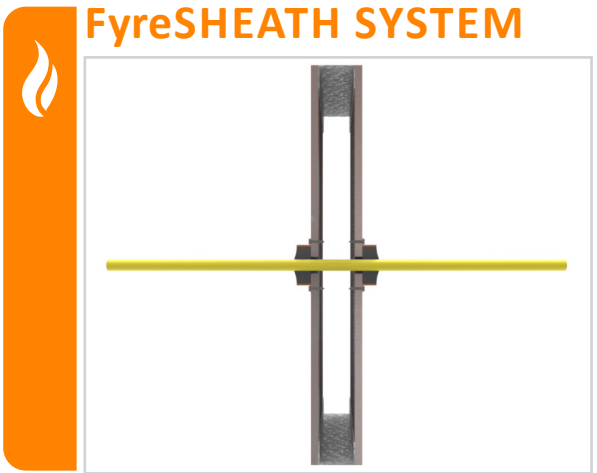

FyrePEX™ HP Sealant filled into 25mm deep metal sheath. No additional wall thickening or patching required.

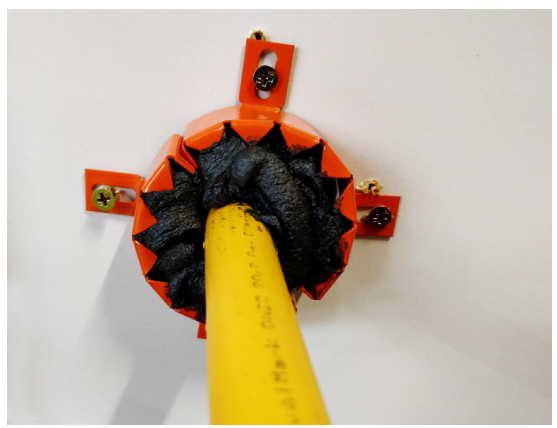

Metal sheath secured to plasterboard wall using minimum 8gx25mm screw fixings. FyrePEX™ HP Sealant to be filled into a metal sheath from each side of the wall. Refer to service specific requirements on [pages 7](#) and [8](#).

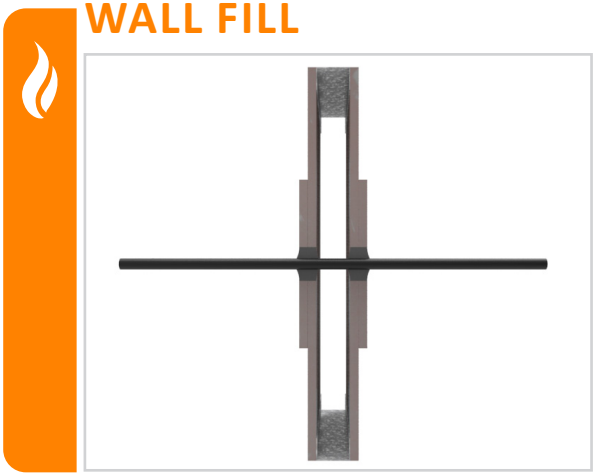

Penetration to be locally thickened with an additional layer of FR plasterboard on each side of the wall. FyrePEX™ HP Sealant then applied to the full depth of the plasterboard. Refer to service specific requirements on [pages 7](#) and [6](#).



FyrePEX™ HP Sealant filled to the full depth of the plasterboard on both sides of the wall.

INSTALLATION WALL SPECIFIC

DOUBLE LAYER PLASTERBOARD

FyreSHEATH SYSTEM

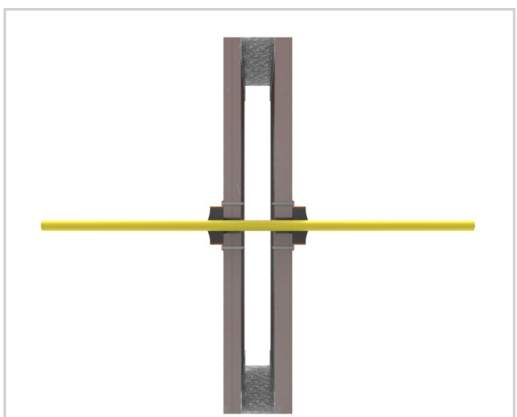

FyrePEX™ HP Sealant to be filled into a metal sheath from each side of the wall. Refer to service specific requirements on [page 9](#).

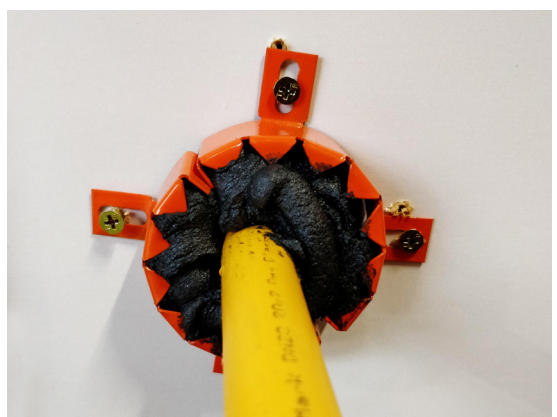

Metal sheath secured to plasterboard wall using minimum 8gx25mm screw fixings.

WALL FILL

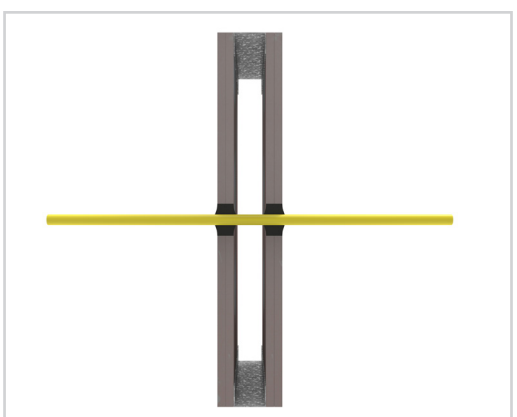

FyrePEX™ HP Sealant applied to the full depth of the plasterboard on each side of the wall. Refer to service specific requirements on [page 9](#).



FyrePEX™ HP Sealant applied to full depth of plasterboard.

INSTALLATION WALL SPECIFIC

CONCRETE/MASONRY

FyreSHEATH SYSTEM

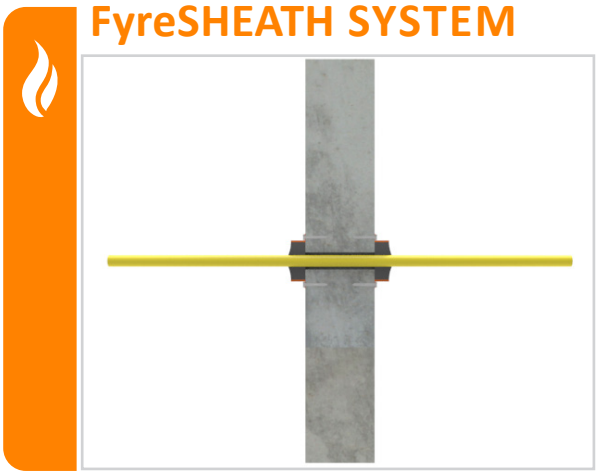

FyrePEX™ HP Sealant to be filled into a metal sheath from each side of the wall. Refer to service specific requirements on [page 10](#).

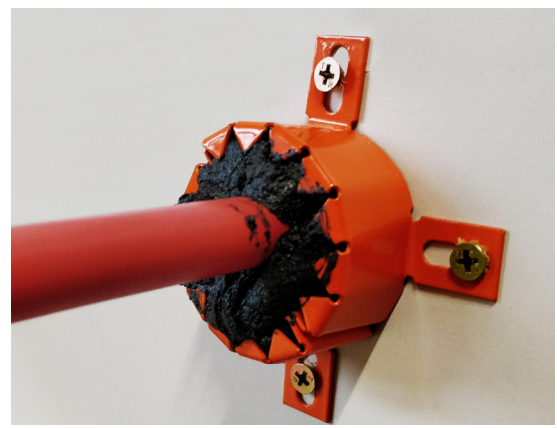

Metal sheath secured to concrete or masonry wall using M6 masonry anchors.

WALL FILL

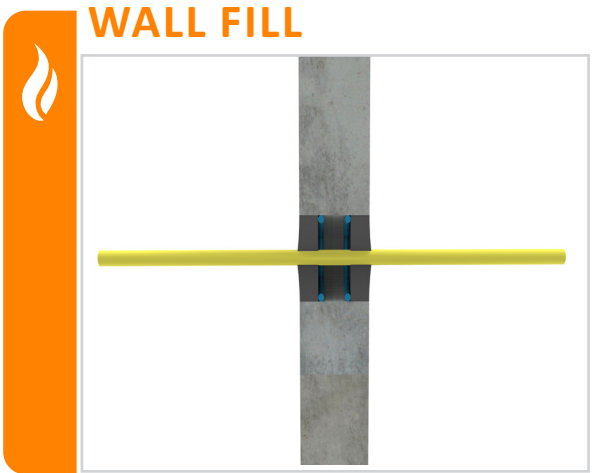

FyrePEX™ HP Sealant to be filled to depth specified. Refer to service specific requirements on [page 10](#).



FyrePEX™ HP Sealant applied to a depth of at least 26mm from each side of the wall.

INSTALLATION

Hebel®, WALSC, SPEEDPANEL & PRONTO

FyreSHEATH SYSTEM

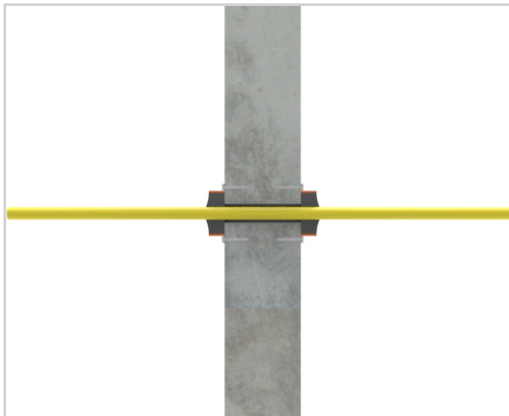

FyrePEX™ HP Sealant to be filled to depth specified. Refer to service specific requirements on [pages 11- 13](#).



FyreSHEATH secured to the wall using minimum 8g x 50mm screws.

WALL FILL

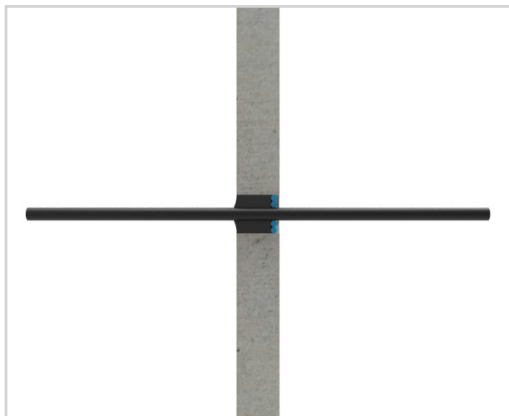

FyrePEX™ HP Sealant installed into wall opening to a depth of at least 60mm from one side only. Refer to service specific requirements on [pages 11 - 13](#)



FyrePEX™ HP Sealant applied to depth of at least 60mm from one side of the wall with fillets if required.

INSTALLATION

CONCRETE FLOORS



FLOOR FILL

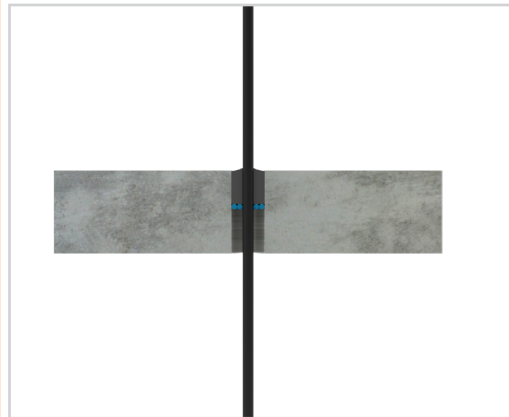

FyrePEX™ HP Sealant installed into Slab opening to a depth of at least 60mm from one side only. Refer to service specific requirements on [page 13](#).



FyrePEX™ HP Sealant applied to depth of at least 60mm from top side of floor slab.

SYSTEM RANGE





- Available in 310ml tube
- Suitable for PEX and air-con pipes and conduit

CLICKABLE CODES

Item Number	Size	Colour	Box Qty
FYREPEX HP310	310ml Cartridge	Black/Dark Grey	25

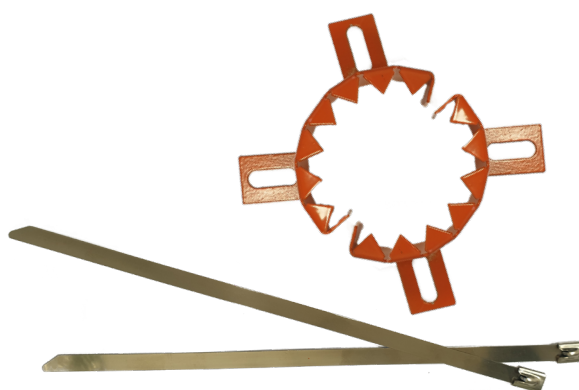
SYSTEM COMPONENTS

- Ensures visible compliance
- Reduces FyrePEX™ HP wastage

CLICKABLE CODES

Item Number	Size	Kit	Qty
FYREPEX Sheath 50mm Set	50mm	2 Sheaths (4 halves) 2 x SS cable ties	1
FYREPEX Sheath 65mm Set	65mm	2 Sheaths (4 halves) 2 x SS cable ties	1

FAQ

Q Is the opening size important?

A Yes, intumescent sealants require the perfect volume of sealant to expand and perform appropriately. Using FyreSHEATH removes the need for larger openings.

Q Do I need access to both sides of the wall?

A Yes, except for Hebel® or Speedpanel® walls and concrete floor slabs which include approved one-sided installations.

Q How far apart do the penetrations need to be spaced?

A Penetrations are required to be spaced 50mm apart.

SOCIAL MEDIA



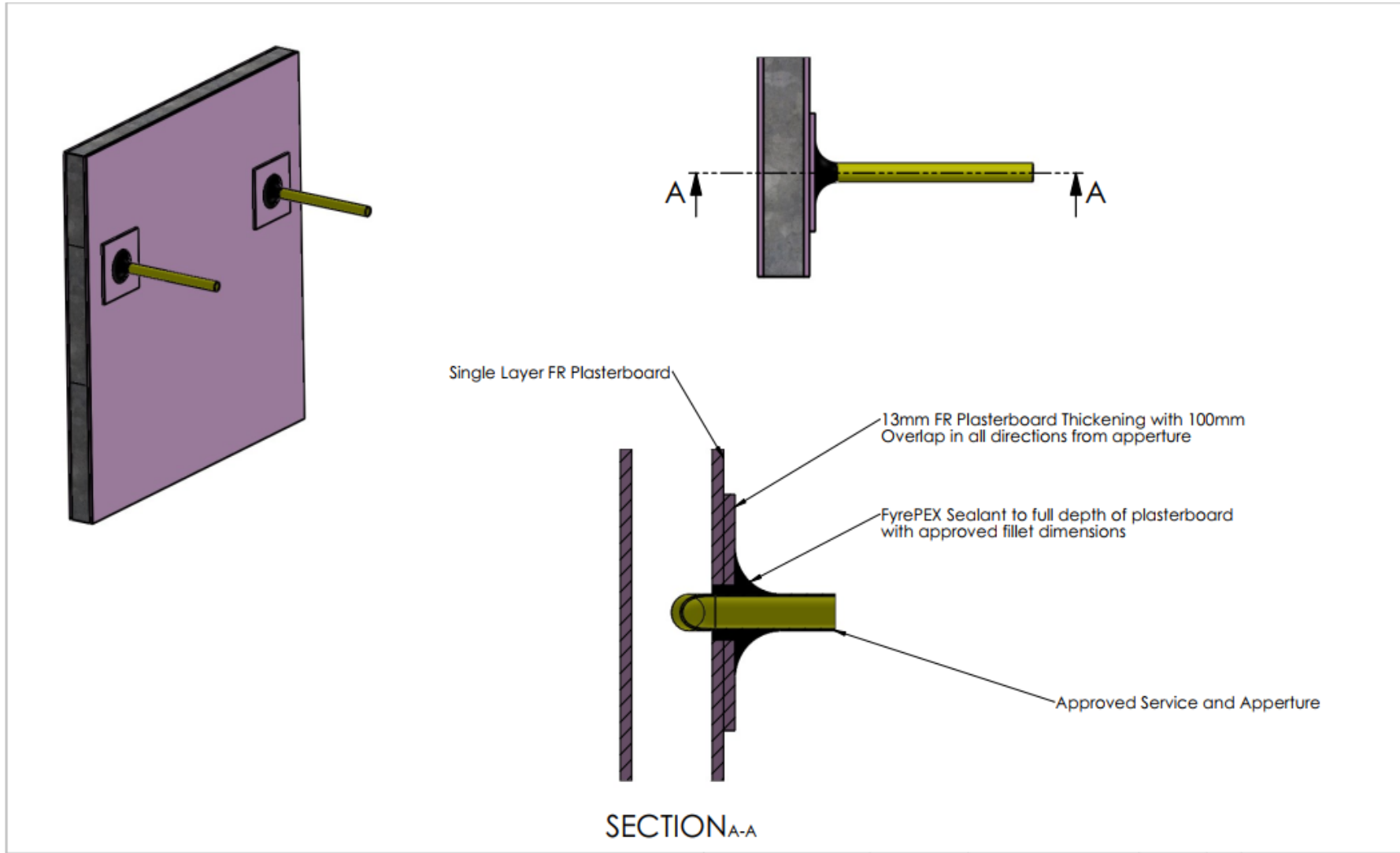

Drawing Name: Plastic or Insulated Pipe Penetration				Test Standard: AS1530.4	Codes:	Revision:	Date:	No.:	NOTICE:
Project Title: FRT 180358.1				Fire resistance level:	Drawn By: DP	<small>NOTE: ALL DIMENSIONS ARE IN MILLIMETRES (mm)</small>			
Drawing No. : 1	Sheet: 1 of 3	Date: 12/04/2022	Scale: NTS	Based on Report No.:	Checked By: JH	<input type="checkbox"/> STANDARD DRAWING	 <small>TRAFALGAR Head Office: PO BOX 545 Chester Hill NSW 2162 T: 1800 888 714 F: 1800 201 500 E: technical@group.com.au W: www.tfire.com.au</small>		
						<input type="checkbox"/> PROJECT DRAWING			