

The fire resistance of FyreWrap Elite 1.5 duct protection system for internal fire exposure

Assessment Report

Author: Keith Nicholls

Assessment Number: FCO-3226 Rev E

Quote Number: CO5212

Date: 10/7/2020

Version: Revision E

The Client: Trafalgar Fire Containment and Unifrax Australia Pty Ltd

Commercial-in-confidence

Inquiries should be addressed to:

Fire Testing and Assessments
NATA Registered Laboratory
14 Julius Avenue
North Ryde, NSW 2113
Telephone +61 2 94905444

Author
Infrastructure Technologies
14 Julius Avenue
North Ryde, NSW 2113
Telephone +61 2 94905500

The Client(s)
Trafalgar Fire Containment
26A Ferndell Street
South Granville, NSW, 2142
Telephone 1800 888 714

Unifrax Australia Pty Ltd
336 Settlement Road
Thomastown, VIC, 3074
Telephone: +61 3 9463 7100



Report Details:

Report CSIRO Reference number: FCO 3226/ CO5212

Report Status and Revision History:

VERSION	STATUS	DATE	DISTRIBUTION	ISSUE NUMBER
Initial Issue	Final	14/11/2016	Client/CSIRO	FCO 3226
Revision A	Final	23/11/2016	Trafalgar/CSIRO	FCO 3226 Rev A
Revision B	Final	23/11/2016	Trafalgar, Unifrax /CSIRO	FCO 3226 Rev B
Revision C	Final	21/11/2018	Trafalgar, Unifrax /CSIRO	FCO 3226 Rev C
Revision D	Final	9/7/2020	Trafalgar, Unifrax /CSIRO	FCO 3226 Rev D
Revision E	Final	9/7/2020	Trafalgar, Unifrax /CSIRO	FCO 3226 Rev E

Report Authorization:

AUTHOR	REVIEWED BY	AUTHORISED BY
Keith Nicholls	Jing Xu	Brett Roddy
		
10 July 2020	10 July 2020	10 July 2020

Copyright and disclaimer

© 2020 CSIRO To the extent permitted by law, all rights are reserved and no part of this publication covered by copyright may be reproduced or copied in any form or by any means except with the written permission of CSIRO.

Important disclaimer

CSIRO advises that the information contained in this publication comprises general statements based on scientific research. The reader is advised and needs to be aware that such information may be incomplete or unable to be used in any specific situation. No reliance or actions must, therefore, be made on that information without seeking prior expert professional, scientific and technical advice. To the extent permitted by law, CSIRO (including its employees and consultants) excludes all liability to any person for any consequences, including but not limited to all losses, damages, costs, expenses and any other compensation, arising directly or indirectly from using this publication (in part or in whole) and any information or material contained in it.

Contents

1 Introduction	4
2 Supporting Data	4
3 Proposed Variations	5
4 Referenced Standards	40
5 Conclusion	40
6 Direct Field of Application of Results	42
7 Requirements	43
8 Term of Validity	43
9 Limitations	43
Appendix A Supporting Test Data	44
Appendix B Analysis of Variations	50

Property of Trafalgar Group

1 Introduction

This report is an assessment of the fire resistance of the FyreWrap Elite 1.5 duct protection system in accordance with AS 1530.4-2014 for internal fire exposure.

This report is prepared for the purpose of meeting the evidence of suitability requirements of NCC Schedule 5 clause 2(c) as appropriate for FRL.

This report reviews and confirms the extent to which the reference fire resistance tests listed in Section 2 meet the requirements of the fire test standards listed in Section 4 of the report. The proposed variations to the tested construction presented in Section 3 are subject to an analysis in Appendix B, and the conclusions are presented in Section 5 of this report.

The field of applicability of the results of this assessment report is presented in Section 6 and subject to the requirements, validity and limitations of Section 7, 8 and 9.

2 Supporting Data

This assessment report refers to various test reports to support the analysis and conclusions of this report. They are listed below;

Report Reference	Test Standard	Outline of Test Specimen
EWFA 35343400.3	AS 1530.4-2014	Fire resistance test of a horizontally orientated duct protected with FyreWrap® Elite 1.5 for internal fire exposure.
FSP 1307	AS 1530.4-2005	Fire resistance test of an Access Panel Installed in a Masonry Wall.
FR 3982	AS 1530.4-2005	Fire resistance test of cable and pipe penetrations in a 130mm thick plasterboard wall.
FSP 1753	AS 1530.4-2014	Fire-Resistance test of five service installations penetrating a 75-mm thick Hebel AAC panel wall system protected by a various Trafalgar Fire passive fire stopping systems.
EWFA 43330700.1	AS 1530.4-2014	Fire resistance test of a vertically orientated duct protected with FyreWrap® Elite 1.5 for internal fire exposure.
FRT 190292.4	AS 1530.4 -2014	A fire resistance test on a 175mm thick concrete slab penetrated by various services protected with various fire stop systems.

The test reports EWFA 35343400.3 and EWFA 43330700.1 were undertaken by Exova Warringtonfire and sponsored by Unifrax Australia Pty. Permission has been provided Unifrax Australia Pty for CSIRO to refer to these report on behalf of Trafalgar Fire Containment.

The test report FRT 190292.4 was 1 were undertaken by Exova Warringtonfire and sponsored by Trafalgar Fire Containment.

The test reports FSP 1753, and FSP 1307 were undertaken by CSIRO North Ryde and sponsored by Trafalgar Fire Containment.

The test reports FR 3982 was undertaken by BRANZ and sponsored by Abesco Limited. Abesco Limited has provided permission for CSIRO to refer to this report on behalf of Trafalgar Fire Containment.

3 Proposed Variations

3.1 Horizontal Ducts

The proposed construction for horizontal ducts for internal exposure only and shall be as tested in EWFA 35343400.3 and subject to the following variations;

- Simultaneous variation of duct size, annular gap, angle size and Maxilite cover strip size as shown in Table 1.
- Duct construction shall be in accordance with AS 4254-2012 Pressure Class 500. Variation to the hanger rod size, hanger spacing, support, duct BMT, stiffeners, jointing shall be in accordance with AS 4254.2-2012 as appropriate for Pressure Class 500.
- The support construction is varied to include Speedpanel, Hebel, masonry (solid and hollow) and plasterboard lined walls as shown in Figure 1 to Figure 16 and with fixing details listed in Tables 2 and 3. The proposed wall construction is required to have been tested or assessed to maintain the required FRL with apertures big enough to accommodate the ducts.
- The second layer of wrap shall be added, and its length varied for 60 and 120-minute applications.
- Optional protection on 2 or 3 sides only when adjacent to fire-resistant construction, refer to Figure 20 and Figure 21.
- The inclusion of a sprinkler head fitted to the face of the duct and supplied with a steel sprinkler pipe up to 48mm OD wrapped with 300mm FyreWrap and sealed at ends of wrap with Fyreflex sealant, refer to Figures 24 and 26.
- The inclusion of a sprinkler head fitted to a riser box and supplied with a steel sprinkler pipe up to 48mm OD wrapped with 300mm FyreWrap and sealed at ends of wrap with Fyreflex sealant, refer to Figures 25 and 27.
- Sprinkler pipe penetration to be located at a Min. 50mm distance from the Maxilite cover strip.
- Refer to Figures 1 to 27 and 32 as well as Tables 1 -3 below.

3.2 Vertical Ducts

The proposed construction for vertical ducts for internal exposure only and shall be as tested in EWFA 43330700.1 and subject to the following variations;

- Simultaneous variation of duct size, annular gap, angle size and Maxilite cover strip size as shown in Table 1.
- Duct construction shall be in accordance with AS 4254-2012 Pressure Class 500. Variation to the hanger rod size, hanger spacing, support, duct BMT, stiffeners, jointing shall be in accordance with AS 4254.2-2012 as appropriate for Pressure Class 500.
- The second layer of wrap shall be added, and its length varied for 60 and 120-minute applications.
- The third layer of wrap shall be added, and its length varied for 120 and 180-minute applications.
- Optional protection on 2 or 3 sides only when adjacent to fire-resistant construction, refer to Figure 20 and Figure 21.
- Duct support shall be as shown in Figure 31
- Inclusion of cable penetration as tested in FRT 190292.4 Specimen 1, protected by 60mm thick Maxilite board and the unexposed side of the duct wall as shown in Figure 32.
- Refer to Figures 18a, 18b, 20 - 23, 28 - 32 and Tables 1 - 3.

Table 1 – Duct Size, Clearance and Maxilite Details

Duct size (mm)	Annular gap sizes	Steel L-angle specifications	Maxilite board specifications
Up to 600x600mm	10-30mm	75x75x1.6mm	100mm width, 60mm thickness
600x600 – 1600x1600mm	20-40mm	75x75x1.6mm	100mm width, 60mm thickness
1600x1600 – 2600x2600mm	40-60mm	125x100x2mm	150mm width, 60mm thickness
2600x2600 – 3600x3600mm	60-80mm	125x100x2mm	150mm width, 60mm thickness

Example – a 400mm high x 1800mm wide duct requires the following specifications:

- The opening between 420-460mm height and 1880-1920mm width
- Steel L-angles to be 125x100x2mm on all sides
- Maxilite board to be 150mm width x 60mm thickness on all sides

Table 2 – Fixing Details

Wall type	Fixing location	Fixing type required	Fixing specification	Maximum centres	Figure Reference
All	Angle to duct	Steel Rivets	5mm diam. x 10mm length	200mm	Figure 1-23
Plasterboard	Angle to wall	Plasterboard screws	8g x 50mm	200mm	Figure 1-4
Plasterboard	Board to wall		8g x 100mm	200mm	
Concrete / masonry	Angle to wall	Min. M6 masonry anchors Length to suit minimum 30mm embedment of anchors in concrete or masonry	M6 x 30mm	400mm	Figure 5-8
Concrete / masonry	Board to wall		M6 x 120mm	400mm	
Hebel	Angle to wall	Type 17 bugle/hex head screws	14g x 50mm	200mm	Figure 9-12
Hebel	Board to wall		14g x 100mm	200mm	
Speedpanel	Angle to wall	Self-drilling screws	10gx30mm	200mm	Figure 13-16
Speedpanel	Board to wall		10gx100mm	200mm	

Table 3 – Hanger Specification and Spacing

For ducts exposed to fire from inside only, duct construction shall be in accordance with AS 4254-2012 Pressure Class 500. Variation to the hanger rod size, hanger spacing, support, duct BMT, stiffeners, jointing shall be in accordance with AS 4254.2-2012 as appropriate for Pressure Class 500

Property of Trafalgar Group

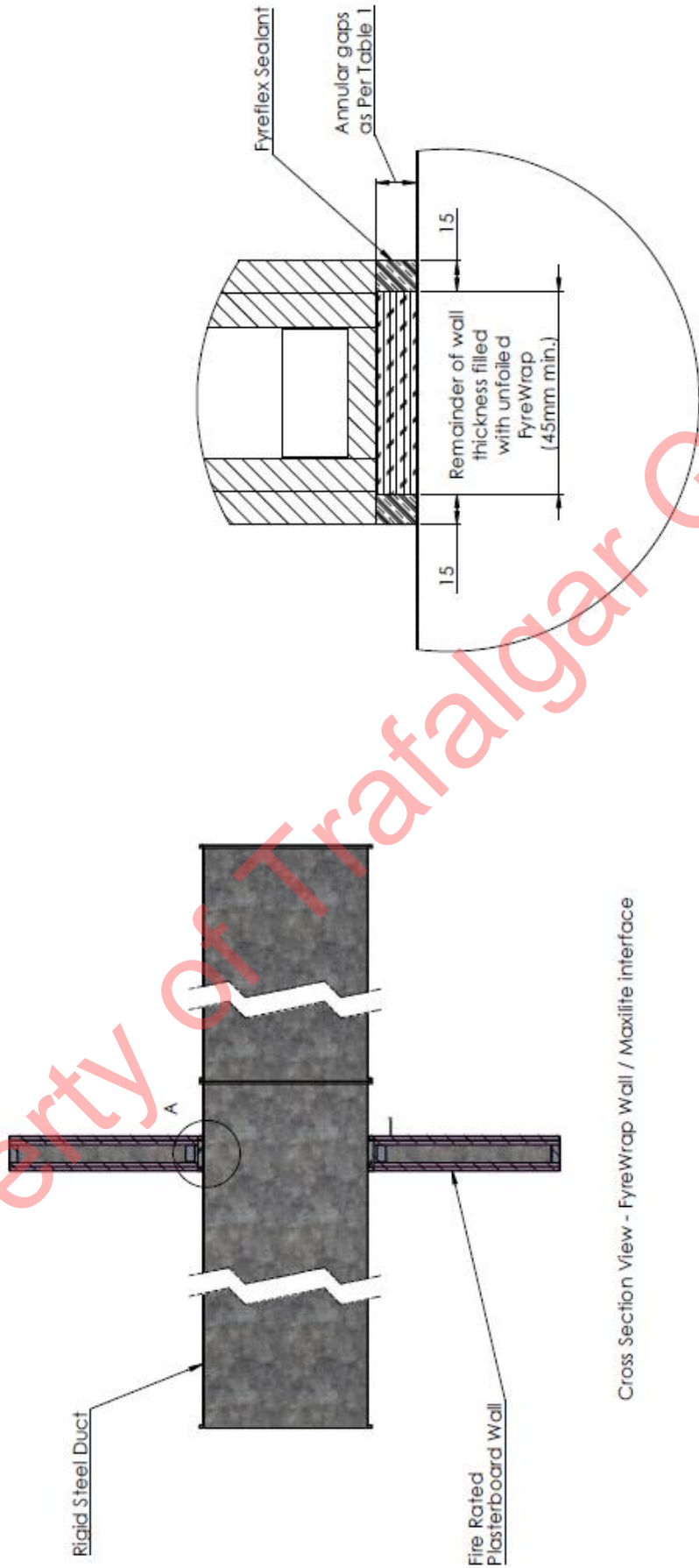

Cross Section View - FyreWrap Wall / Maxilite interface

Figure 1 – Plasterboard Wall Installation (Step 1)

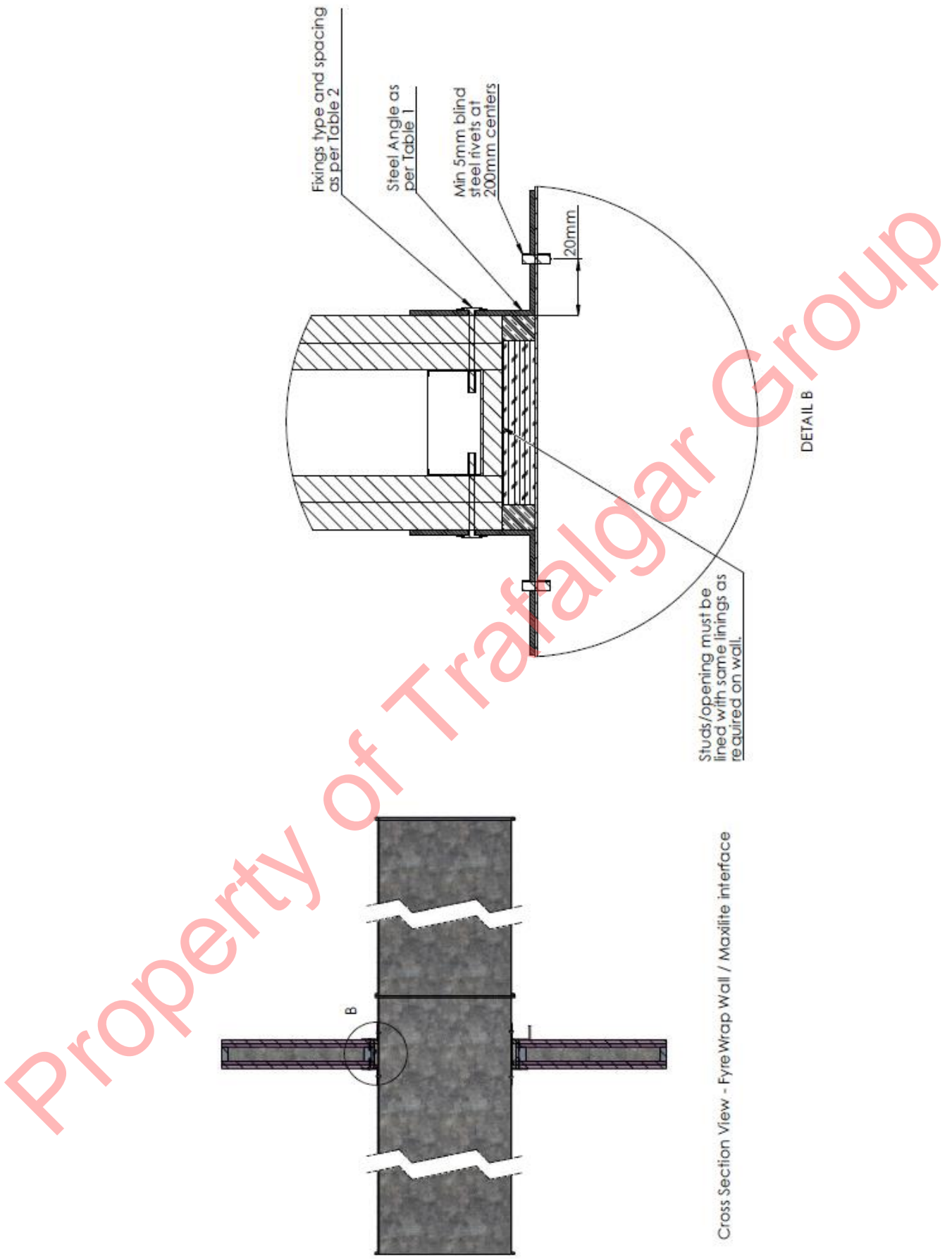

Figure 2 – Plasterboard Wall Installation (Step 2)

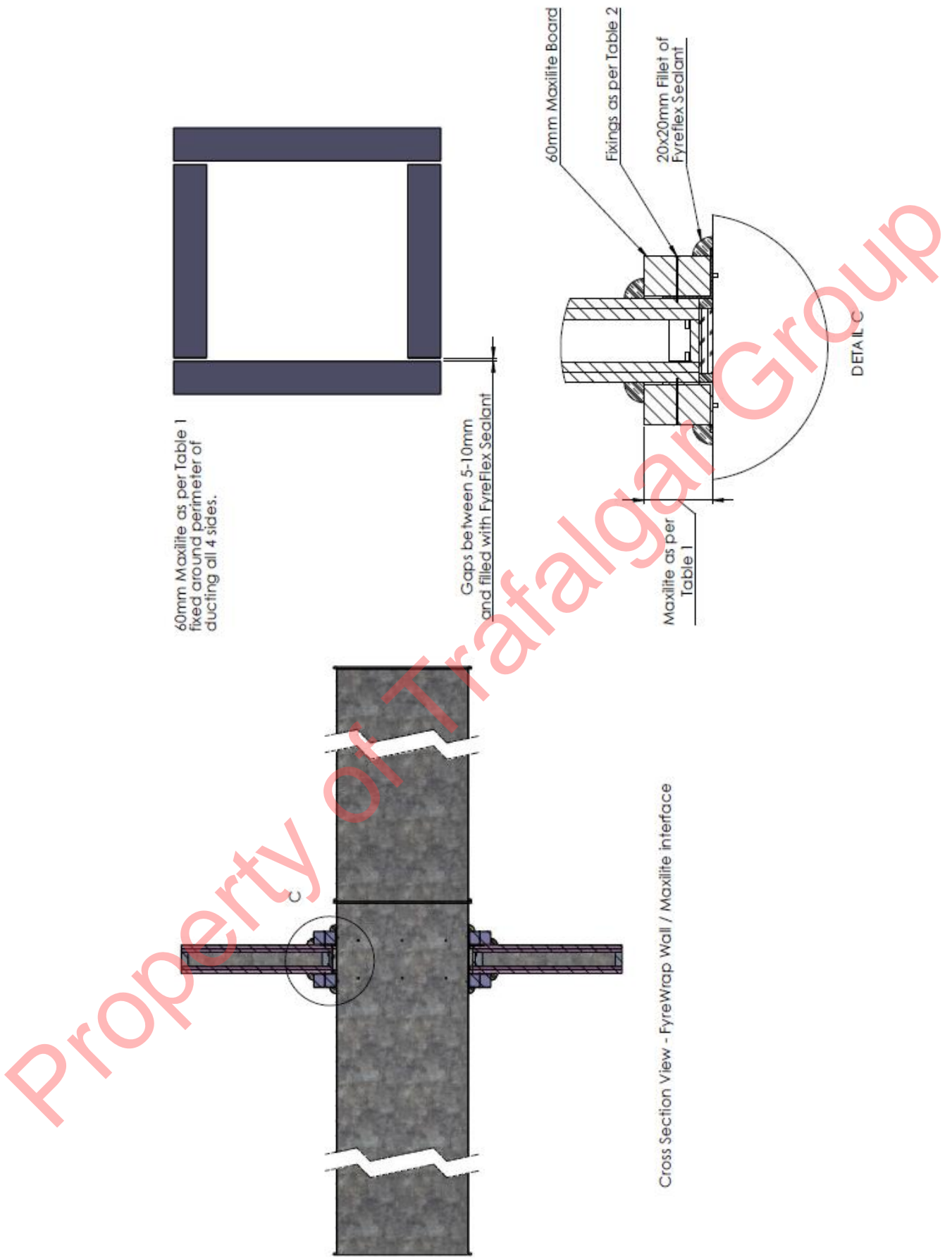
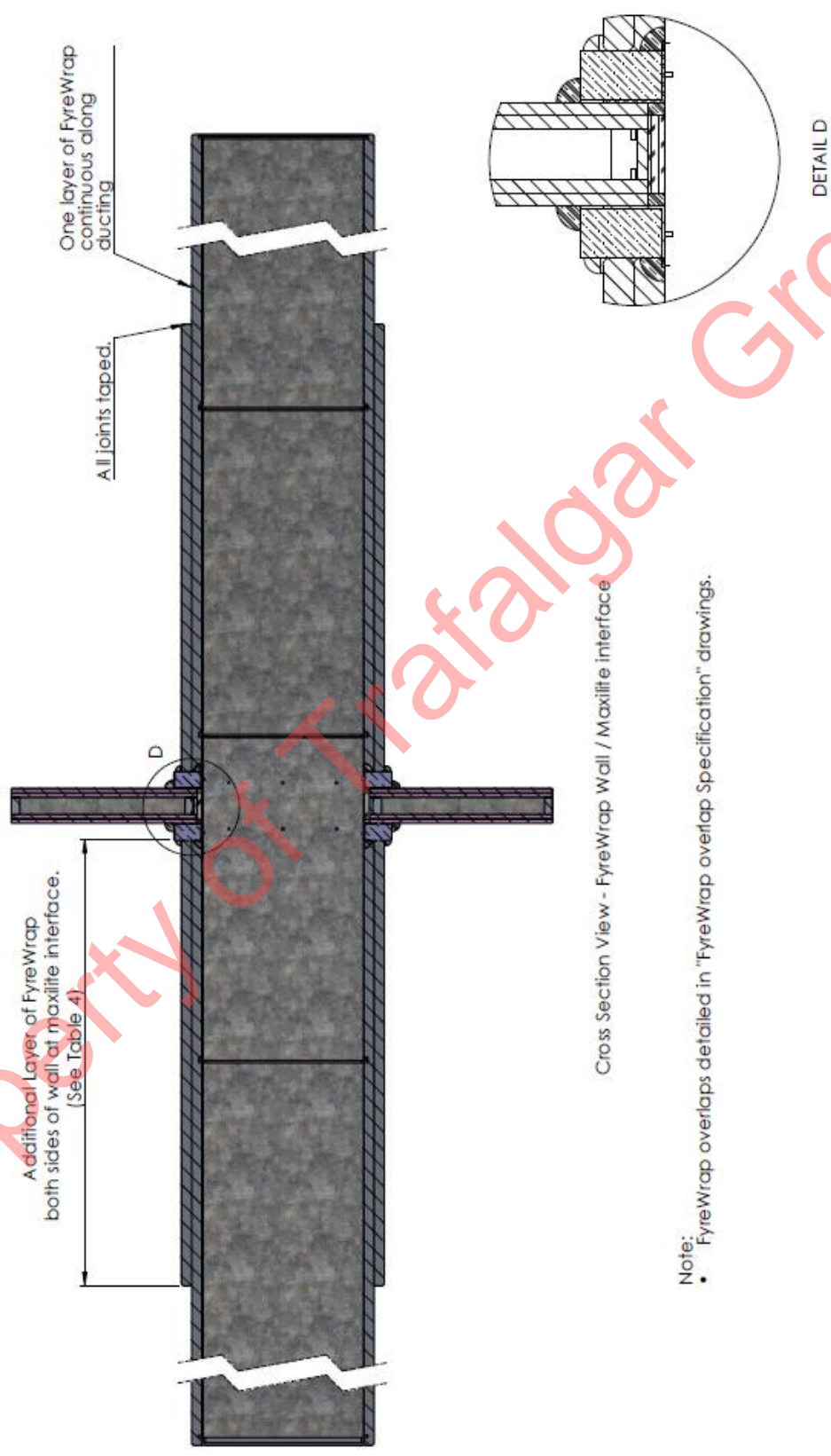

Figure 3 – Plasterboard Wall Installation (Step 3)



Note:

- FyreWrap overlaps detailed in "FyreWrap overlap Specification" drawings.

Figure 4 – Plasterboard Wall Installation (Final)

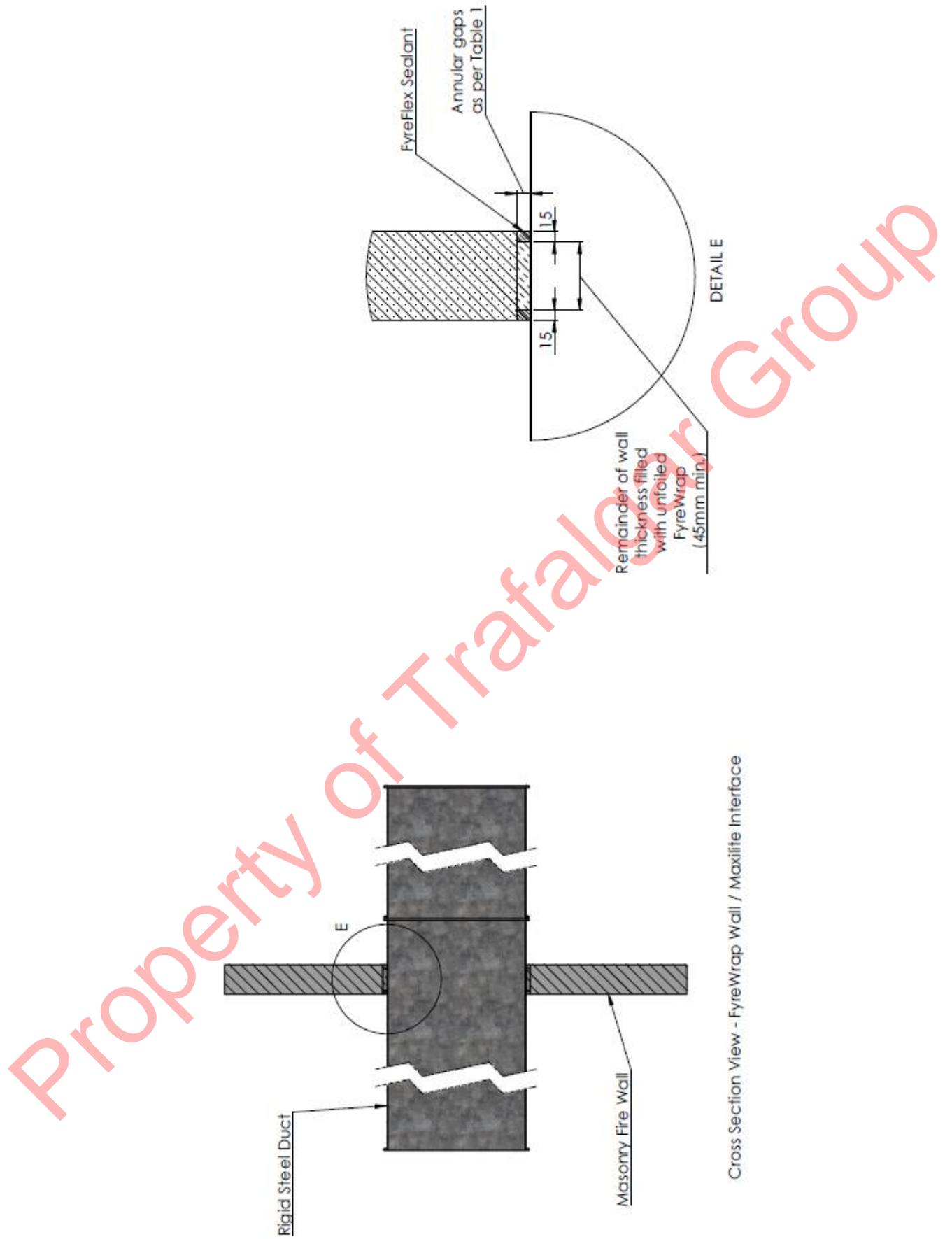

Figure 5 – Masonry Wall Installation (Step 1)

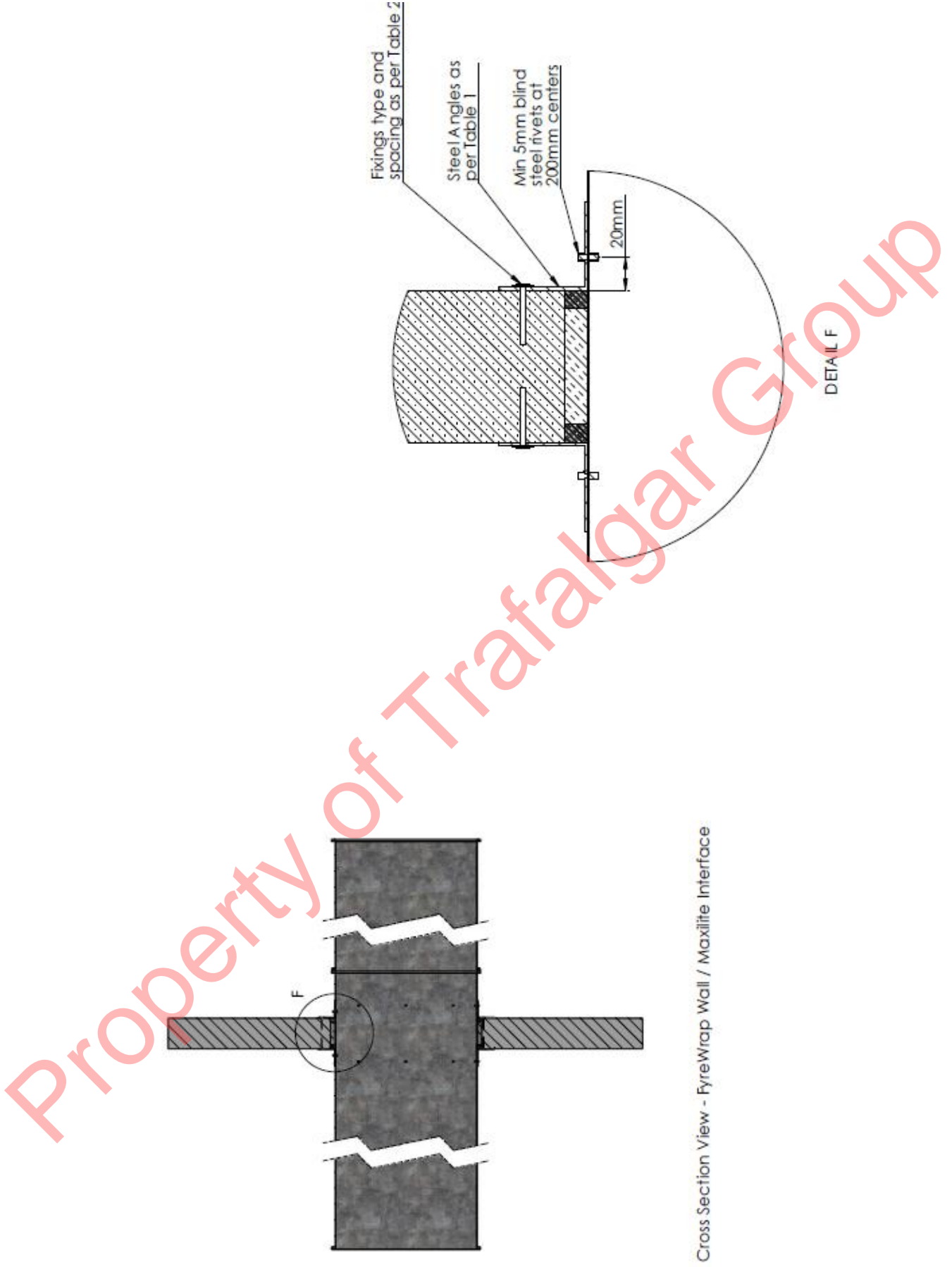

Figure 6 – Masonry Wall Installation (Step 2)

Cross Section View - FyreWrap Wall / Maxlite Interface

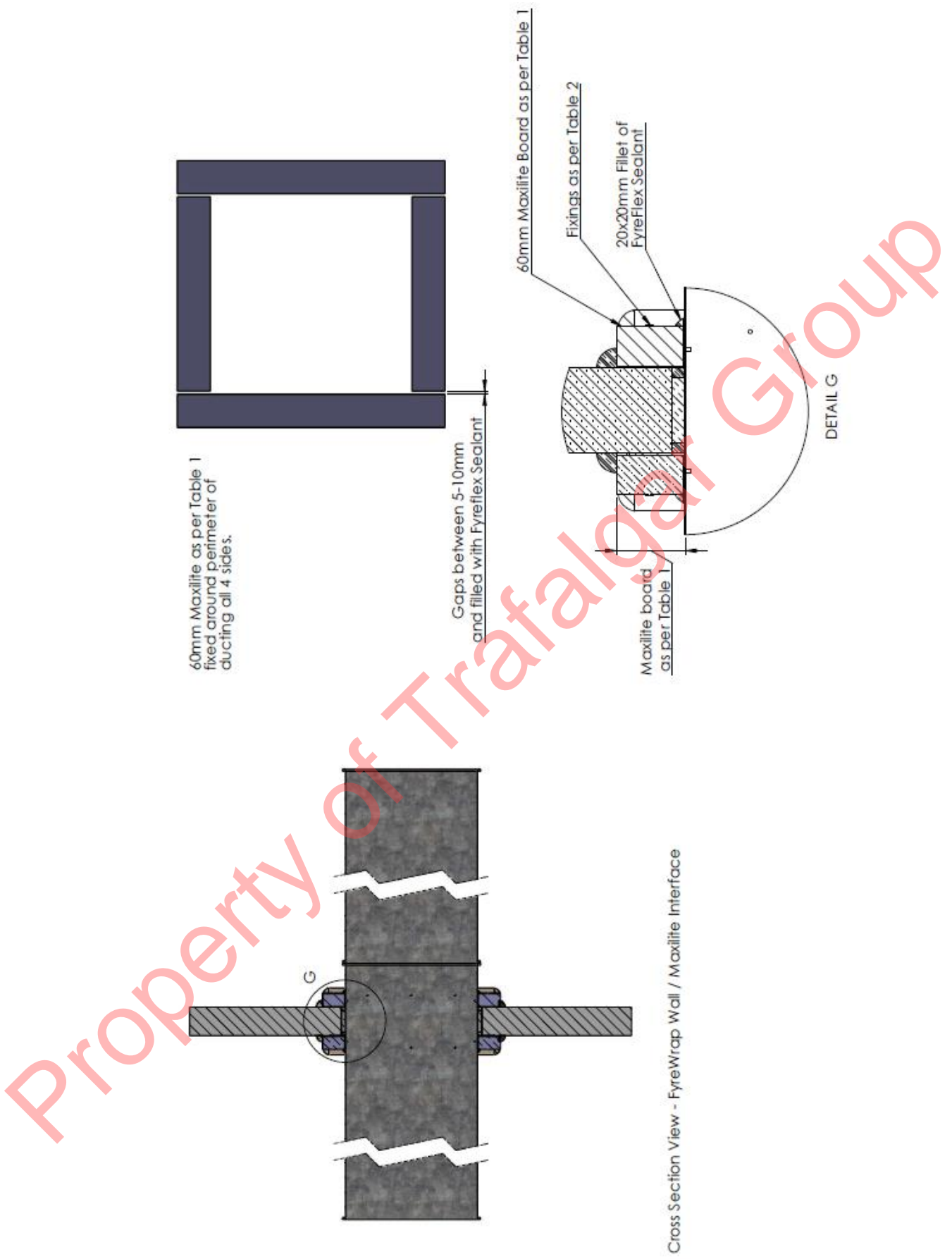
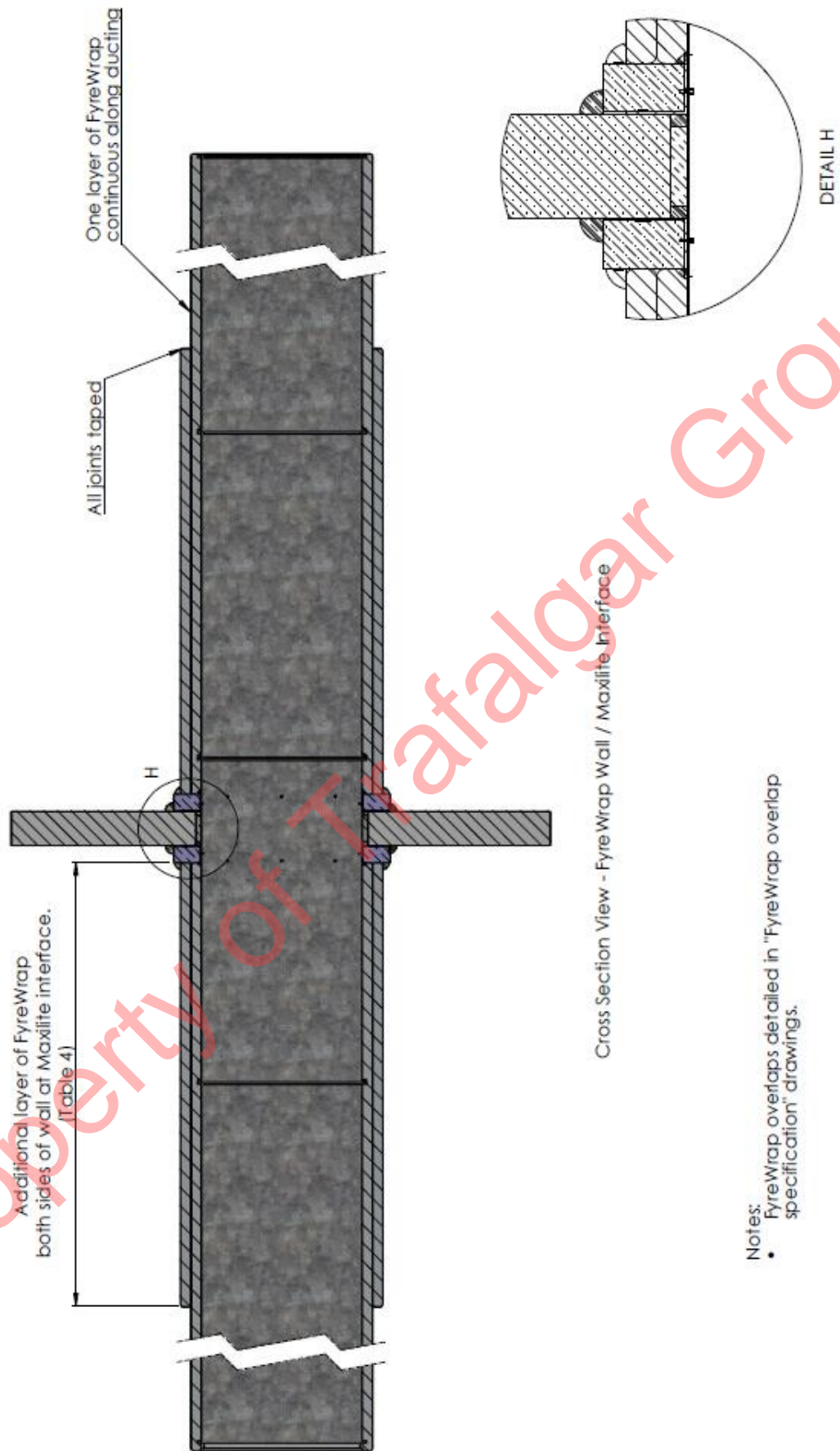

Figure 7 – Masonry Wall Installation (Step 3)



- Notes:
- FyreWrap overlaps detailed in "FyreWrap overlap specification" drawings.

Figure 8 – Masonry Wall Installation (Final)

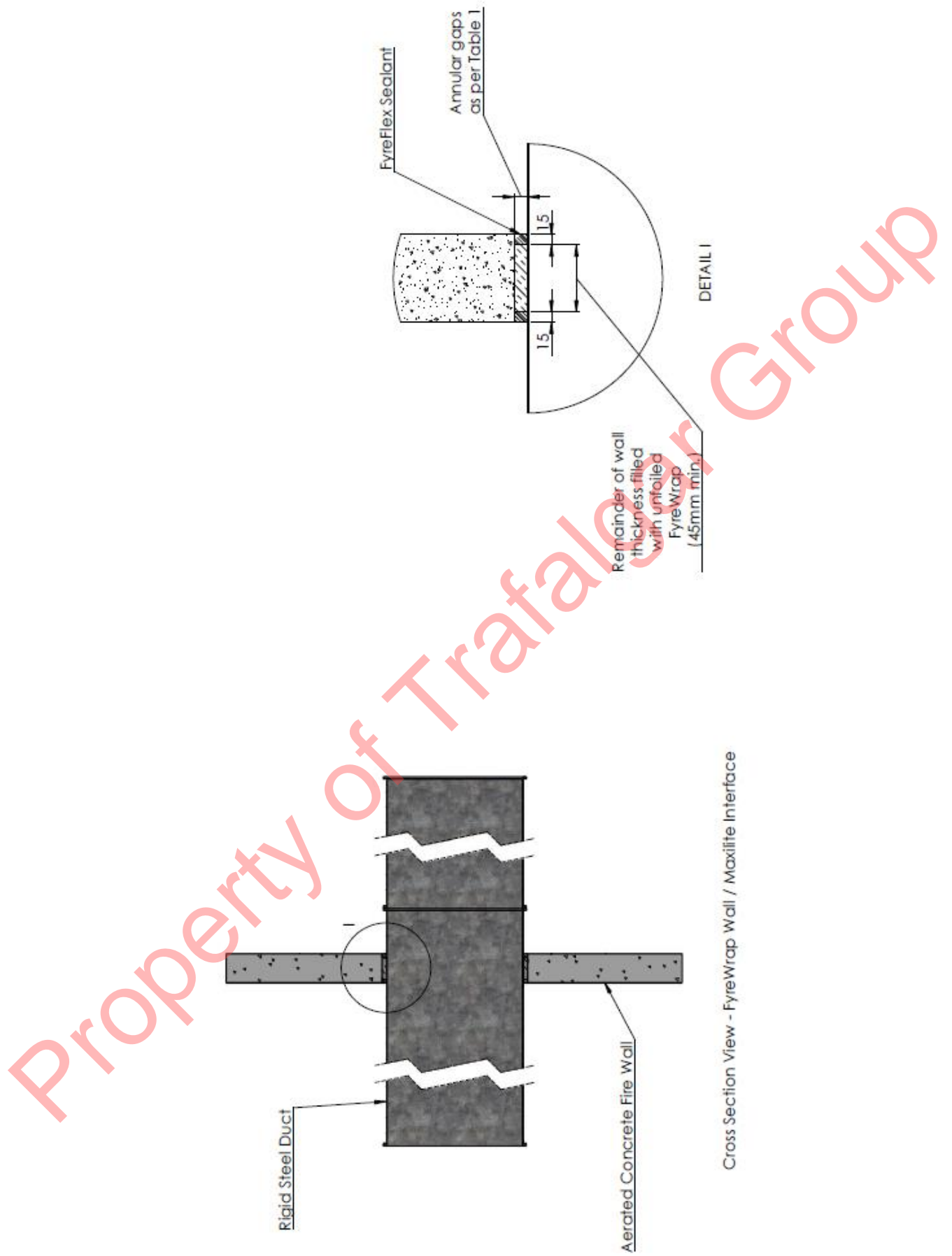

Figure 9 – AAC Wall Installation (Step 1)

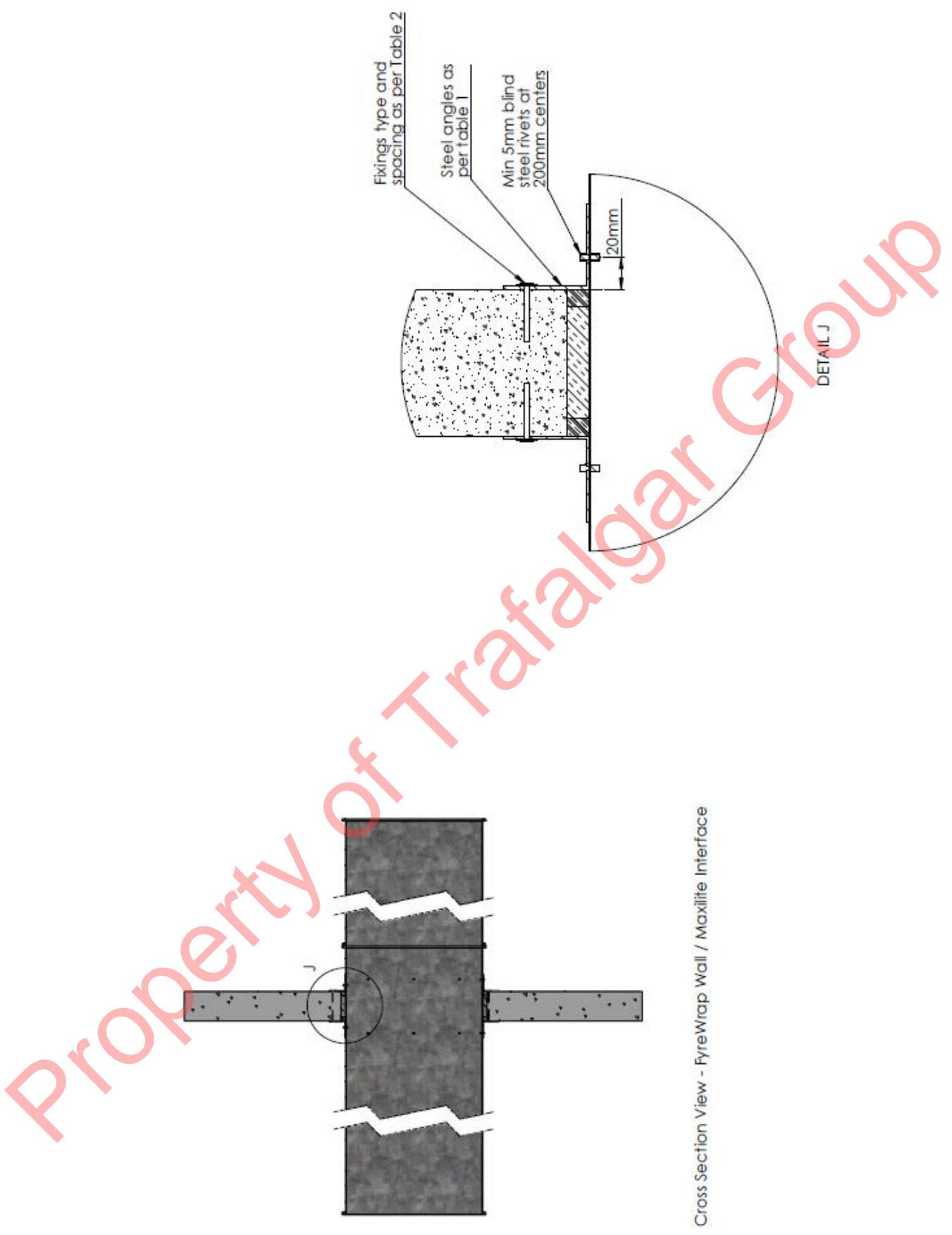

Figure 10 – AAC Wall Installation (Step 2)

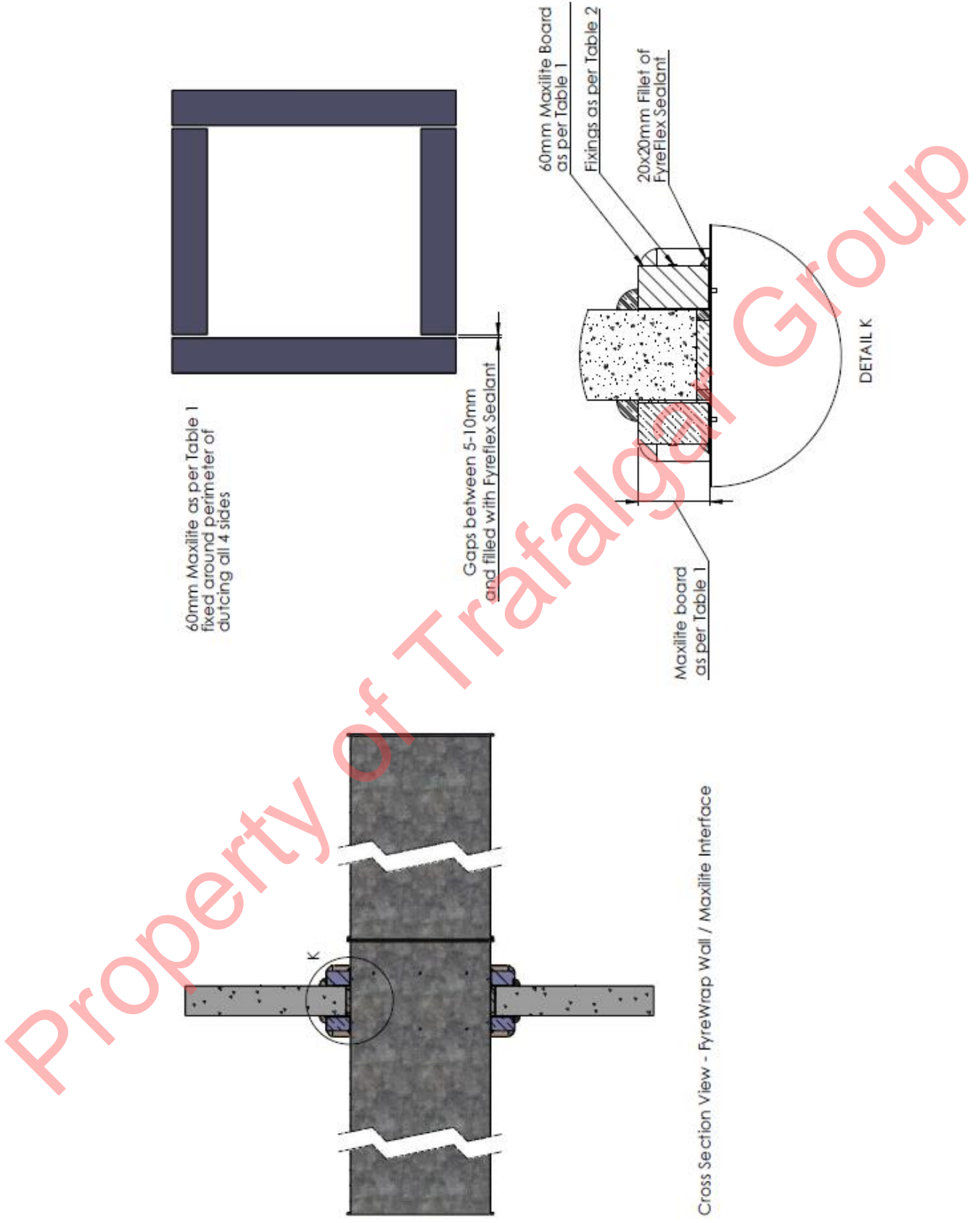
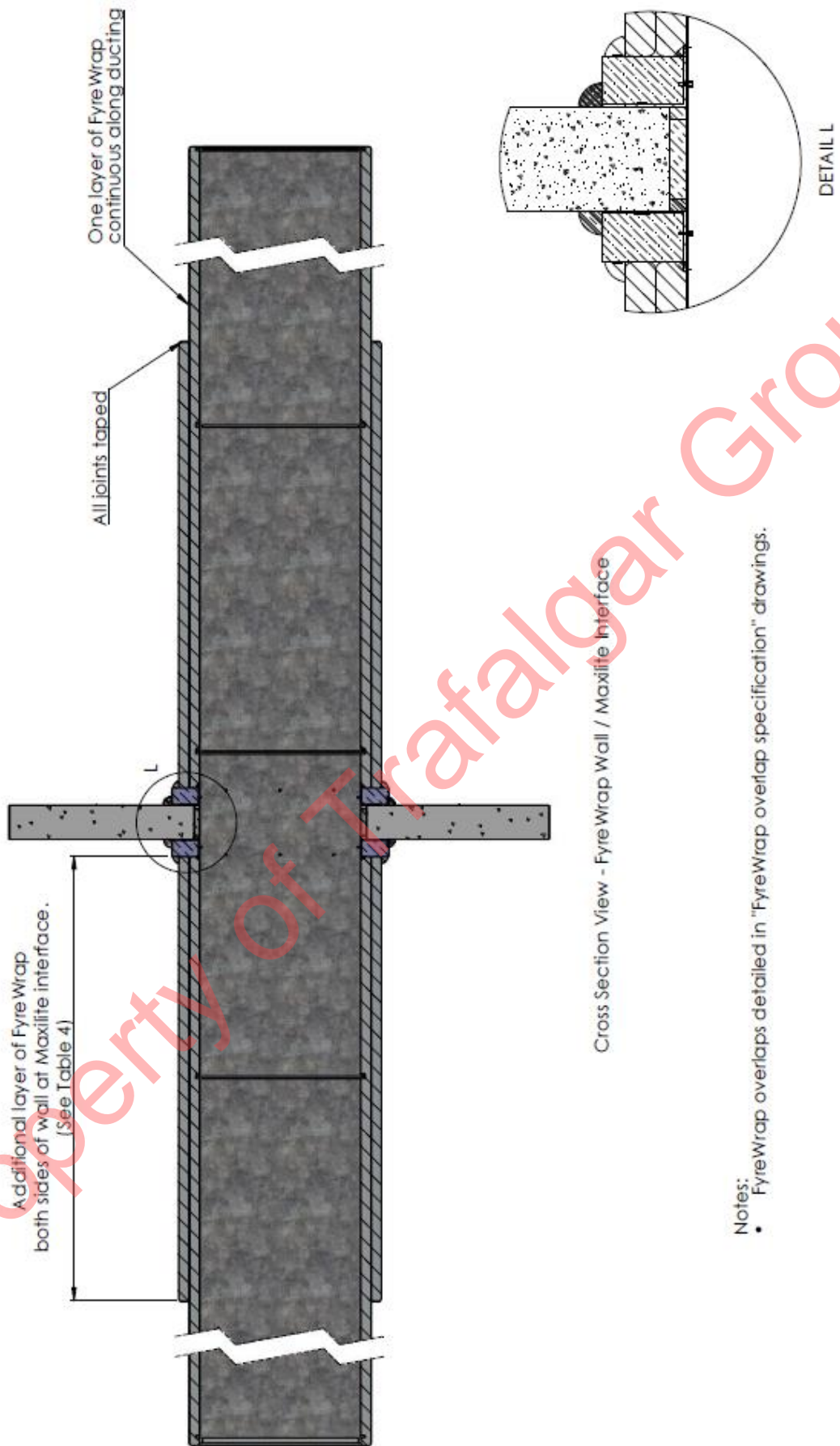

Figure 11– AAC Wall Installation (Step 3)



- Notes:
- FyreWrap overlaps detailed in "FyreWrap overlap specification" drawings.

Figure 12 – AAC Wall Installation (Final)

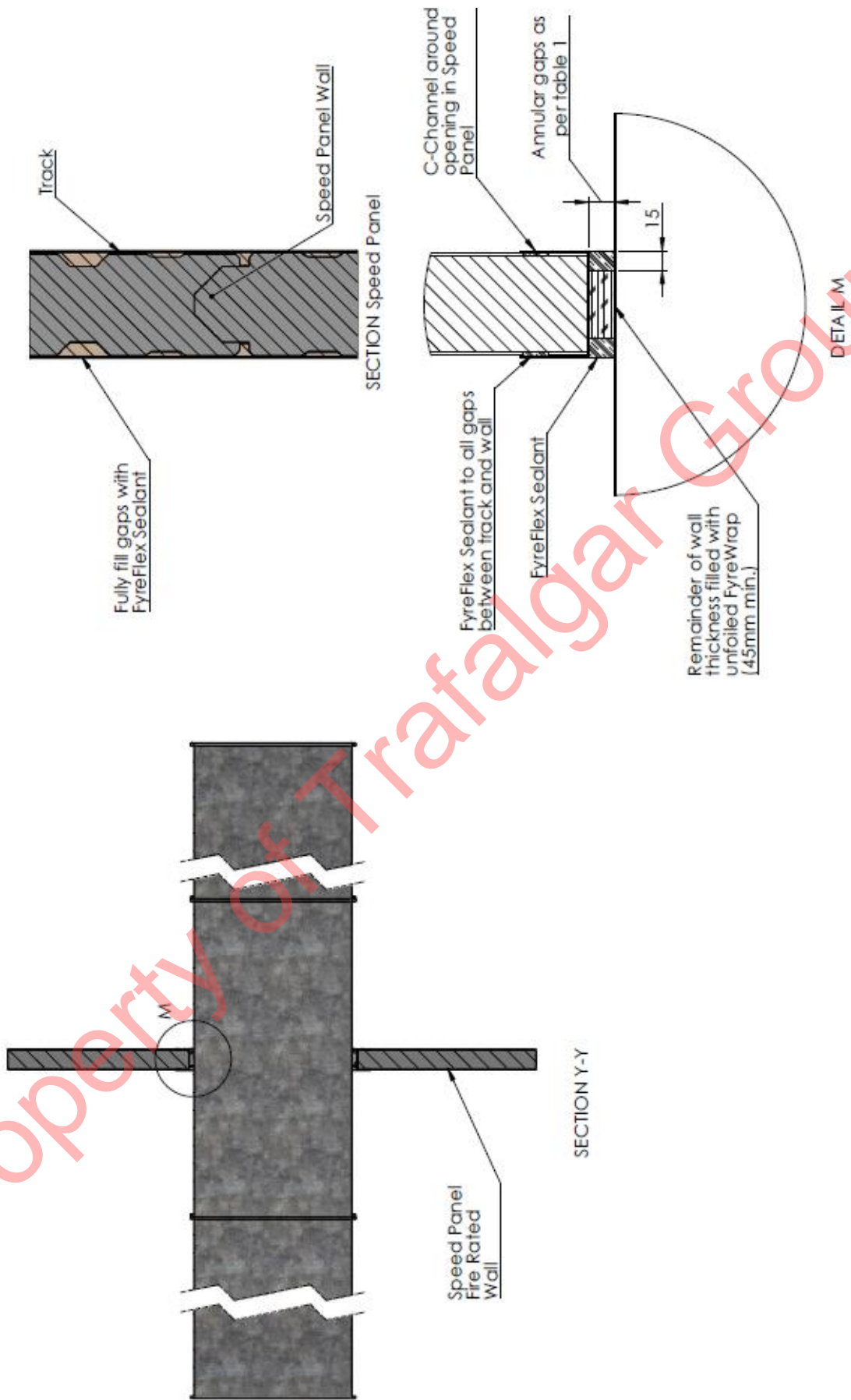
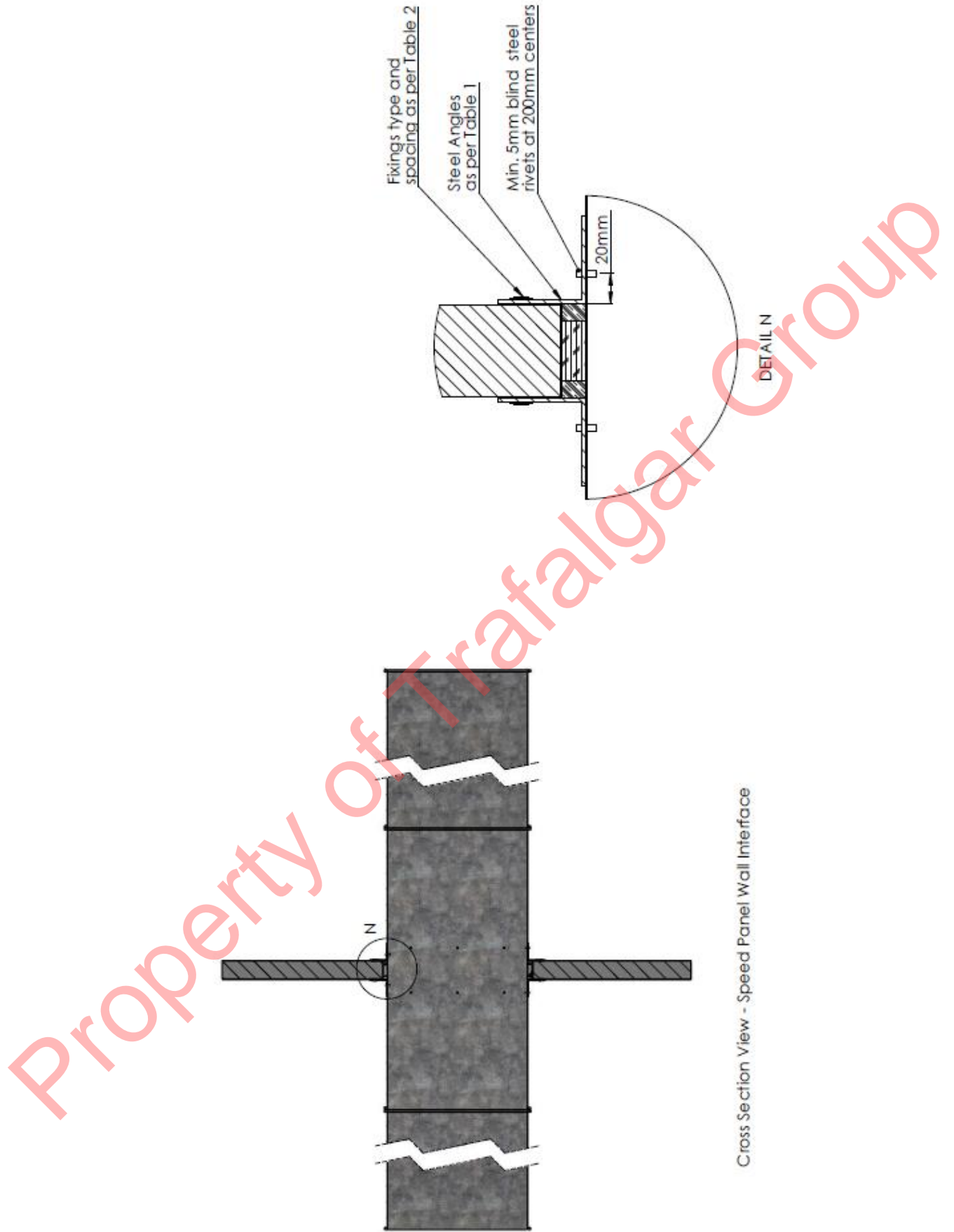

Figure 13 – Speedpanel Wall Installation (Step 1)



.Figure 14 – Speedpanel Wall Installation (Step 2)

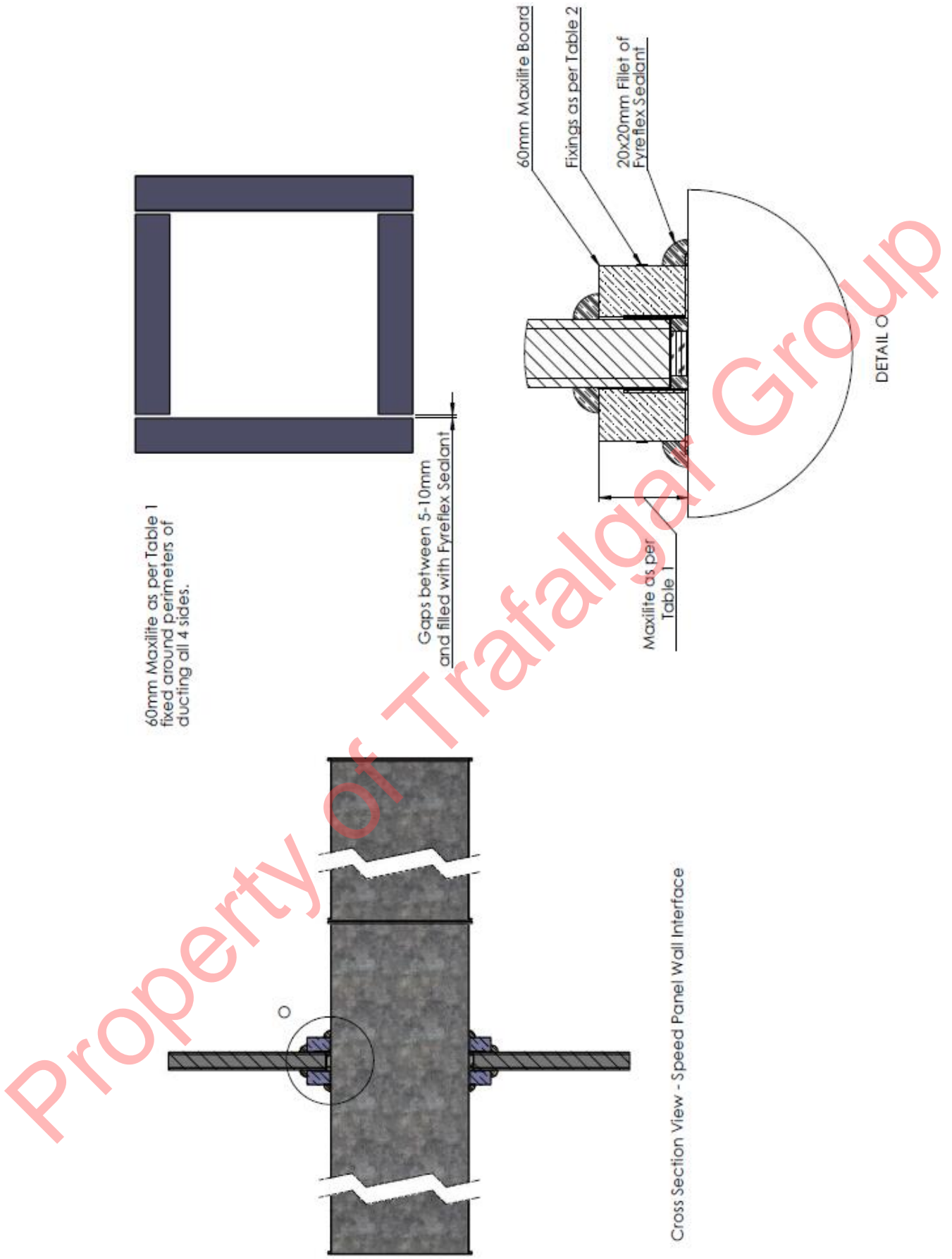
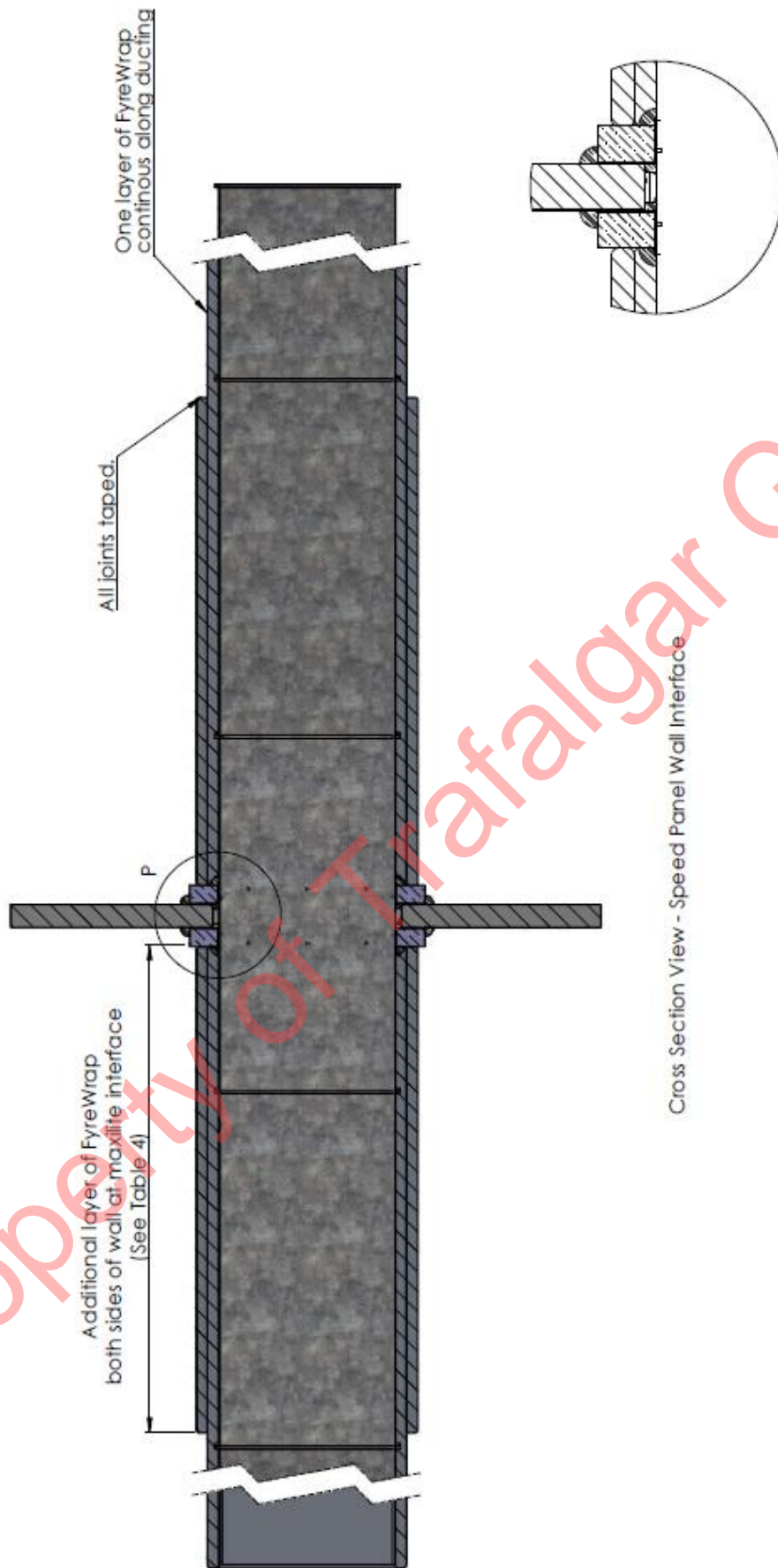

Figure 15 – Speedpanel Wall Installation (Step 3)



Cross Section View - Speed Panel Wall Interface

DETAIL P

- Notes:
- FyreWrap overlaps detailed in "FyreWrap overlap Specification" drawings.

Figure 16 – Speedpanel Wall Installation (Final)

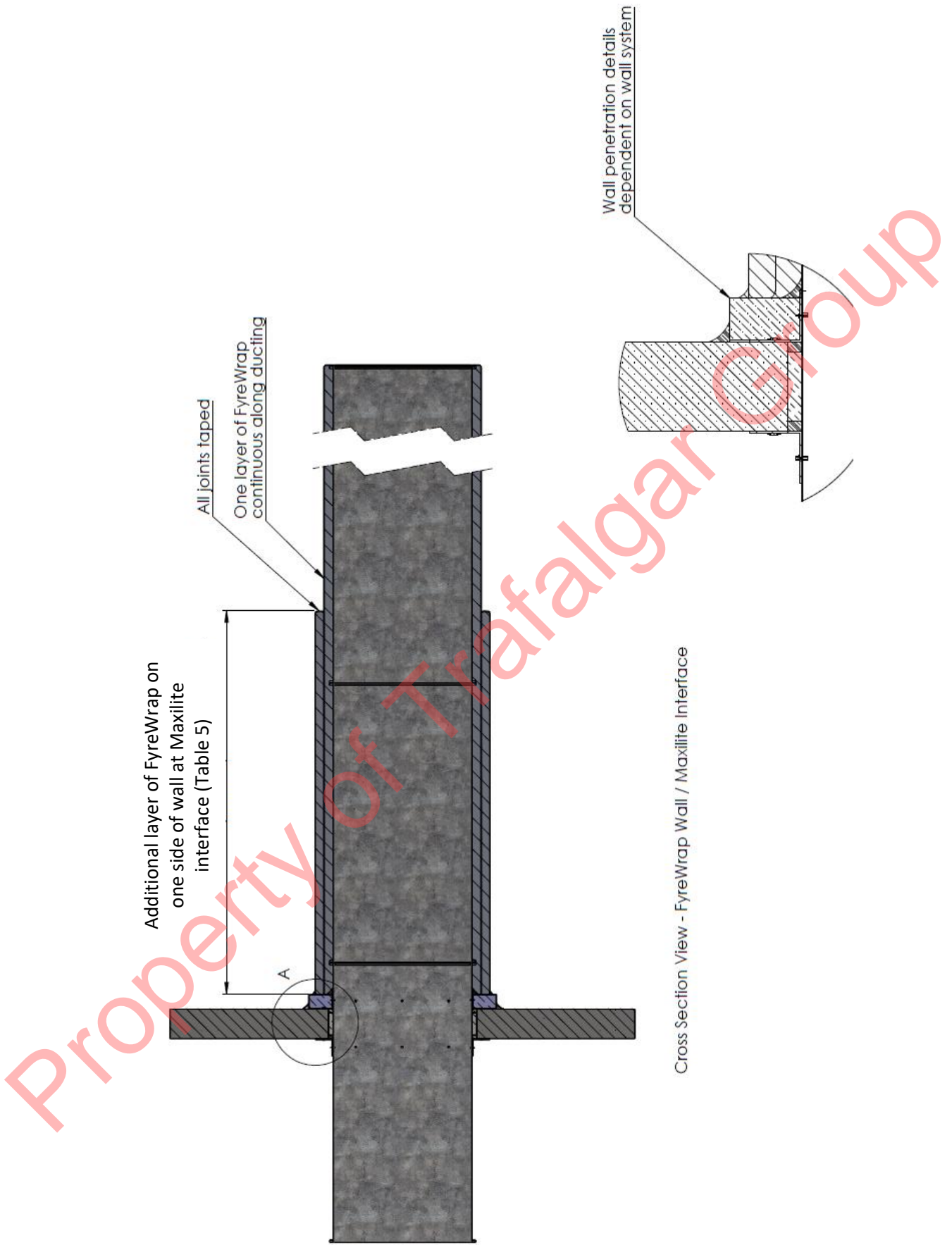

Figure 17 – General detail for duct where protection is only required on one side of the wall

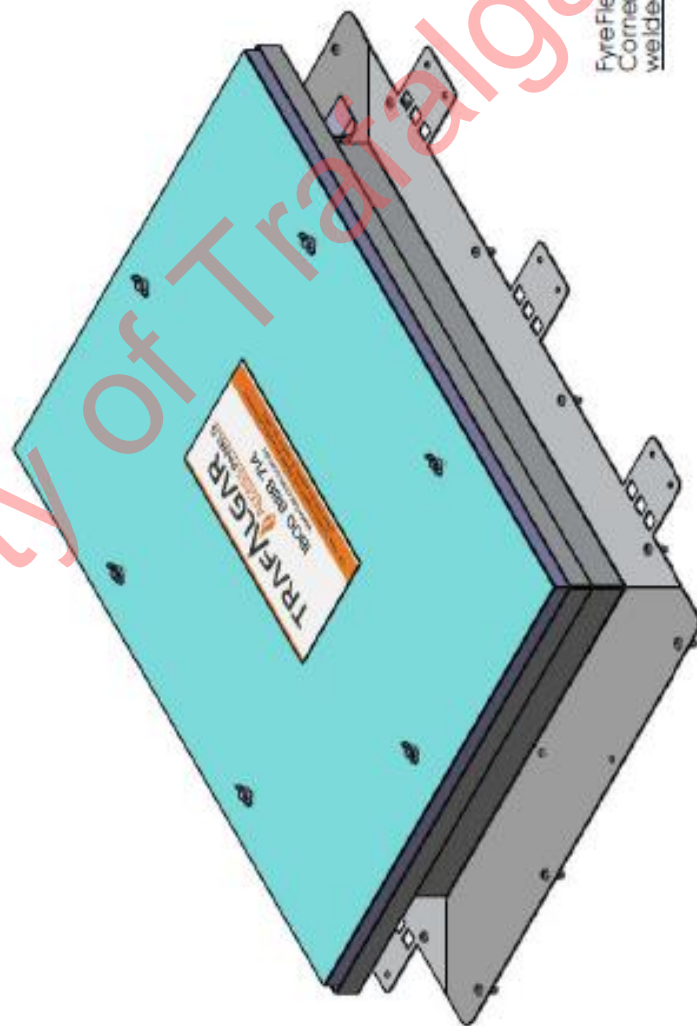
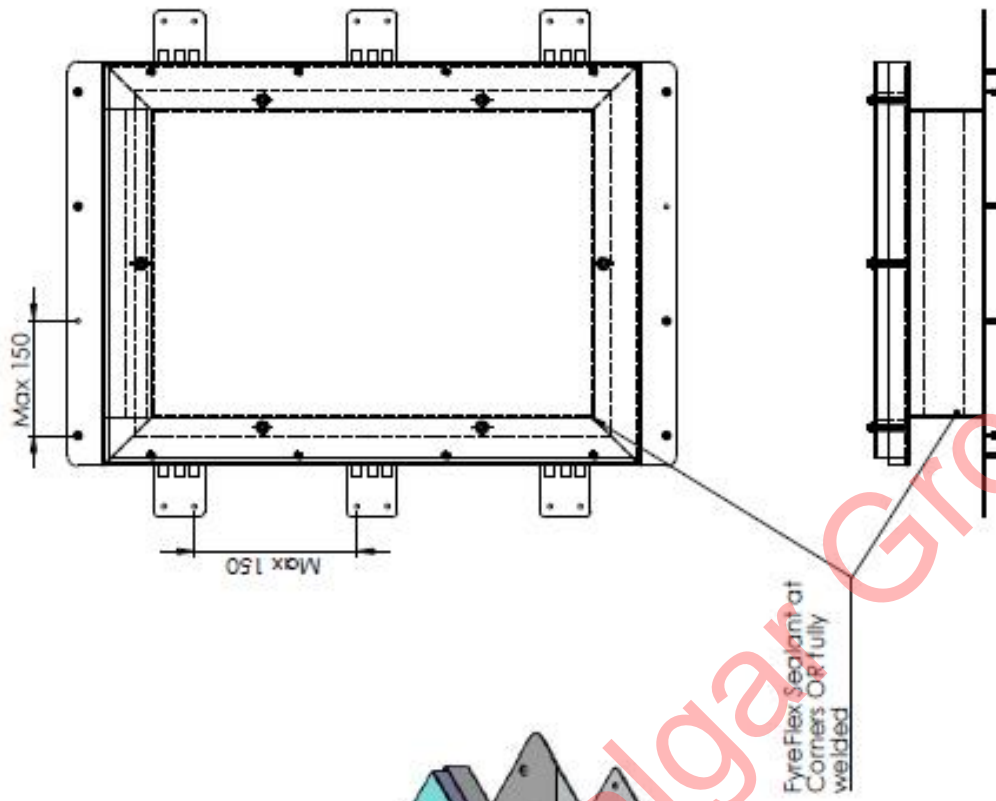

Figure 18a – Access Panel Frame and Hatch Detail

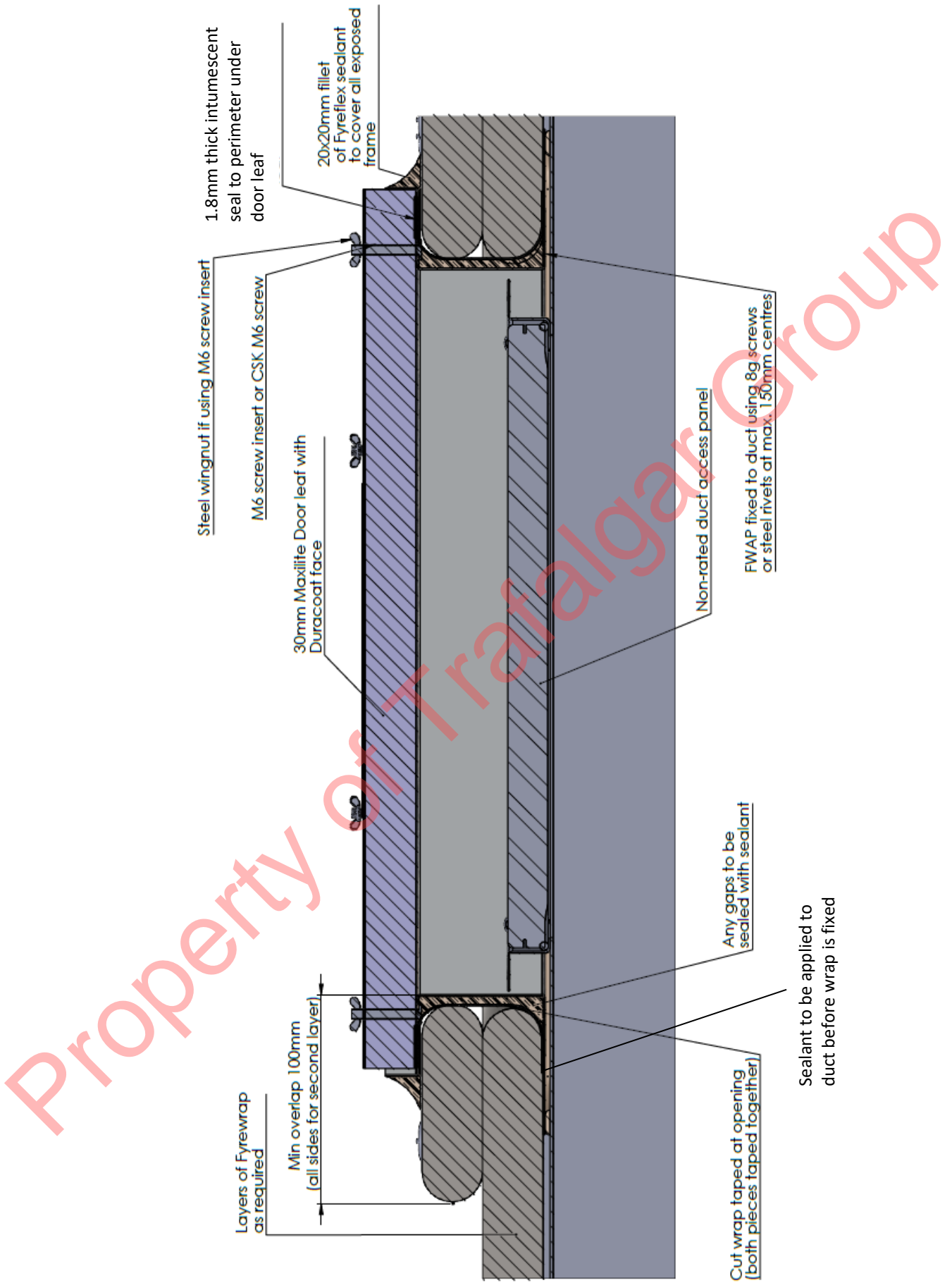

Figure 18b – Generic Access Panel Fixing and Sealing Detail

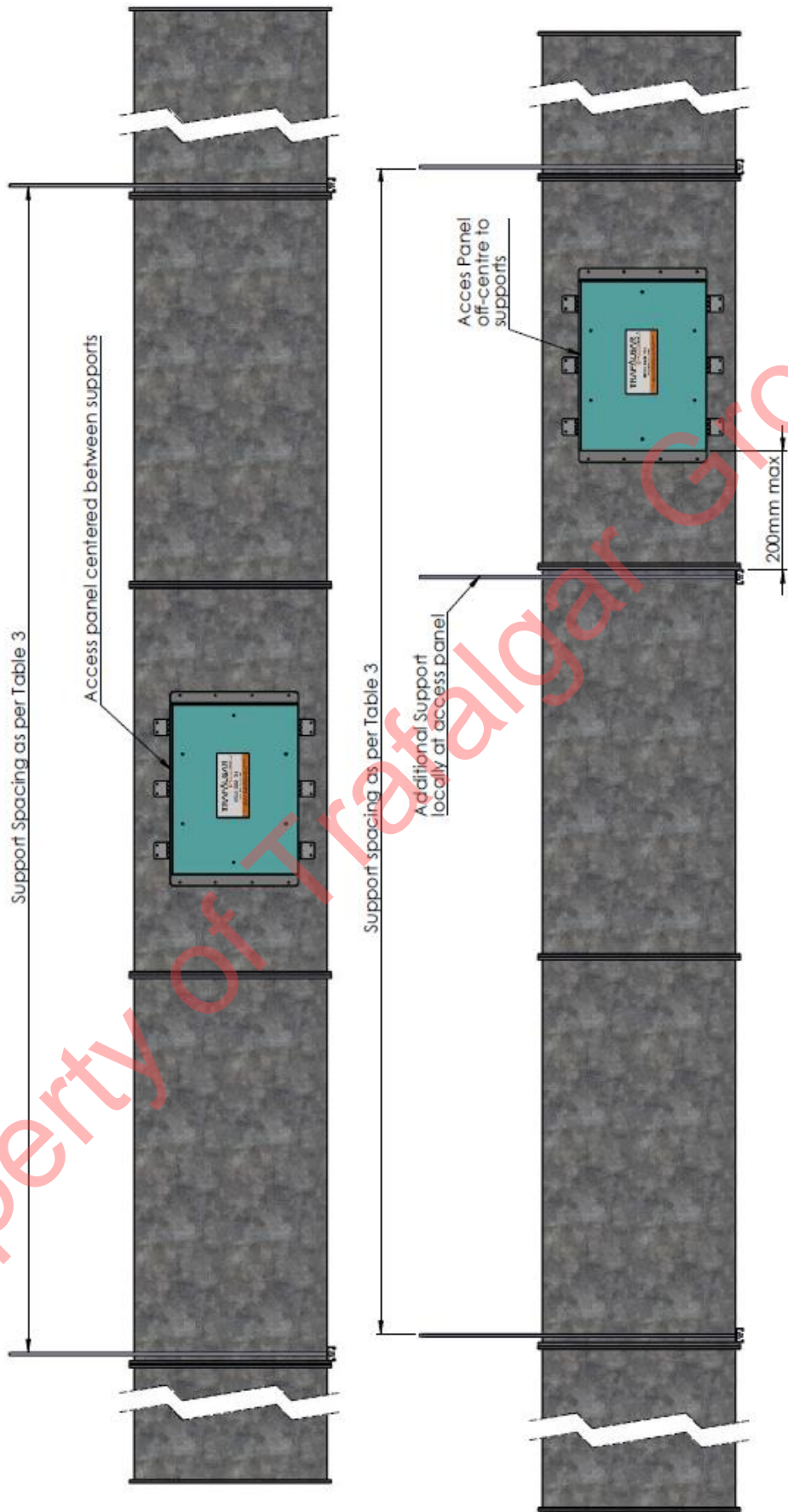
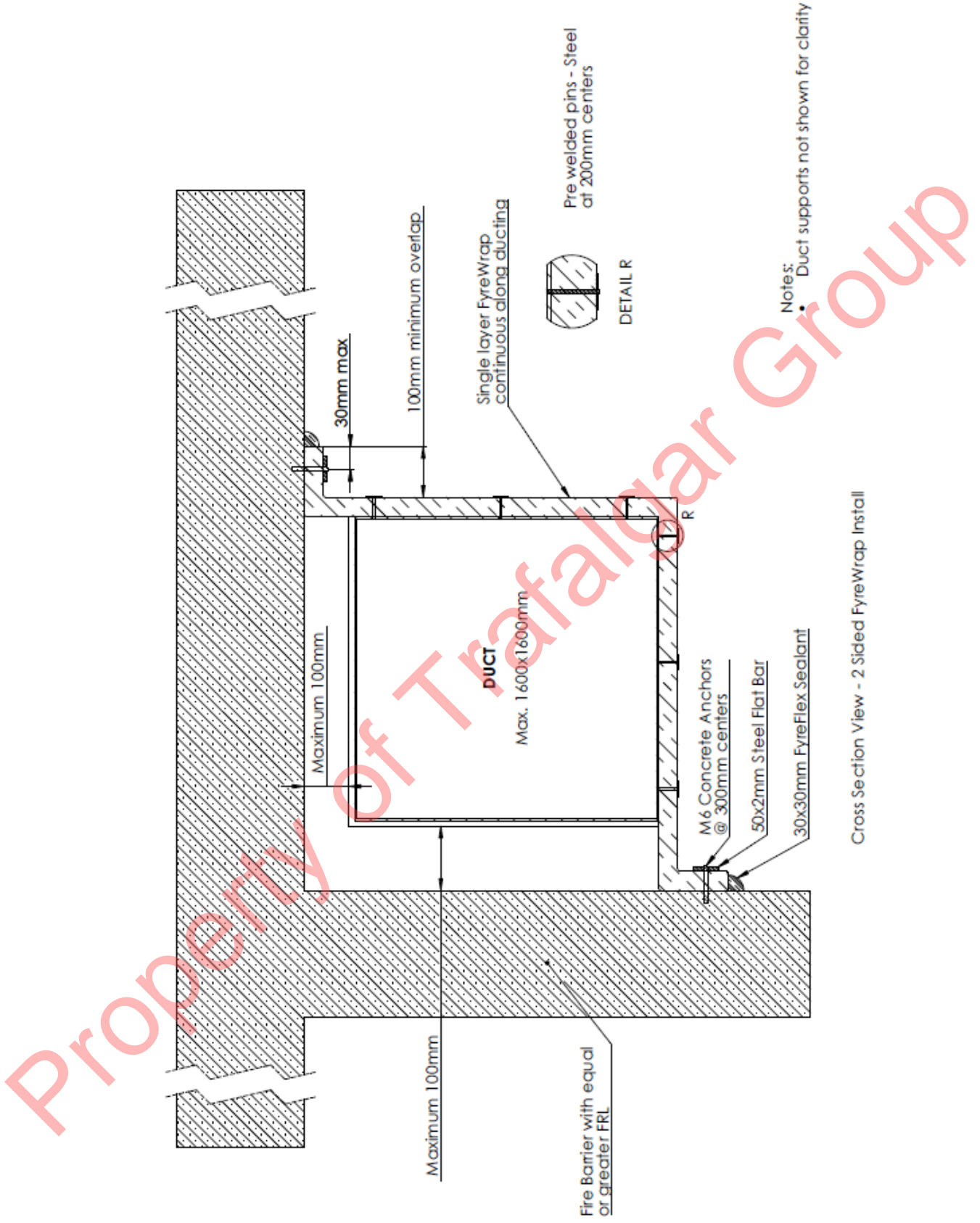

Figure 19 – Access Panel Location and additional Supports



Notes:
 • Duct supports not shown for clarity

Cross Section View - 2 Sided FyreWrap Install

Figure 20 – 2 Sided Installations

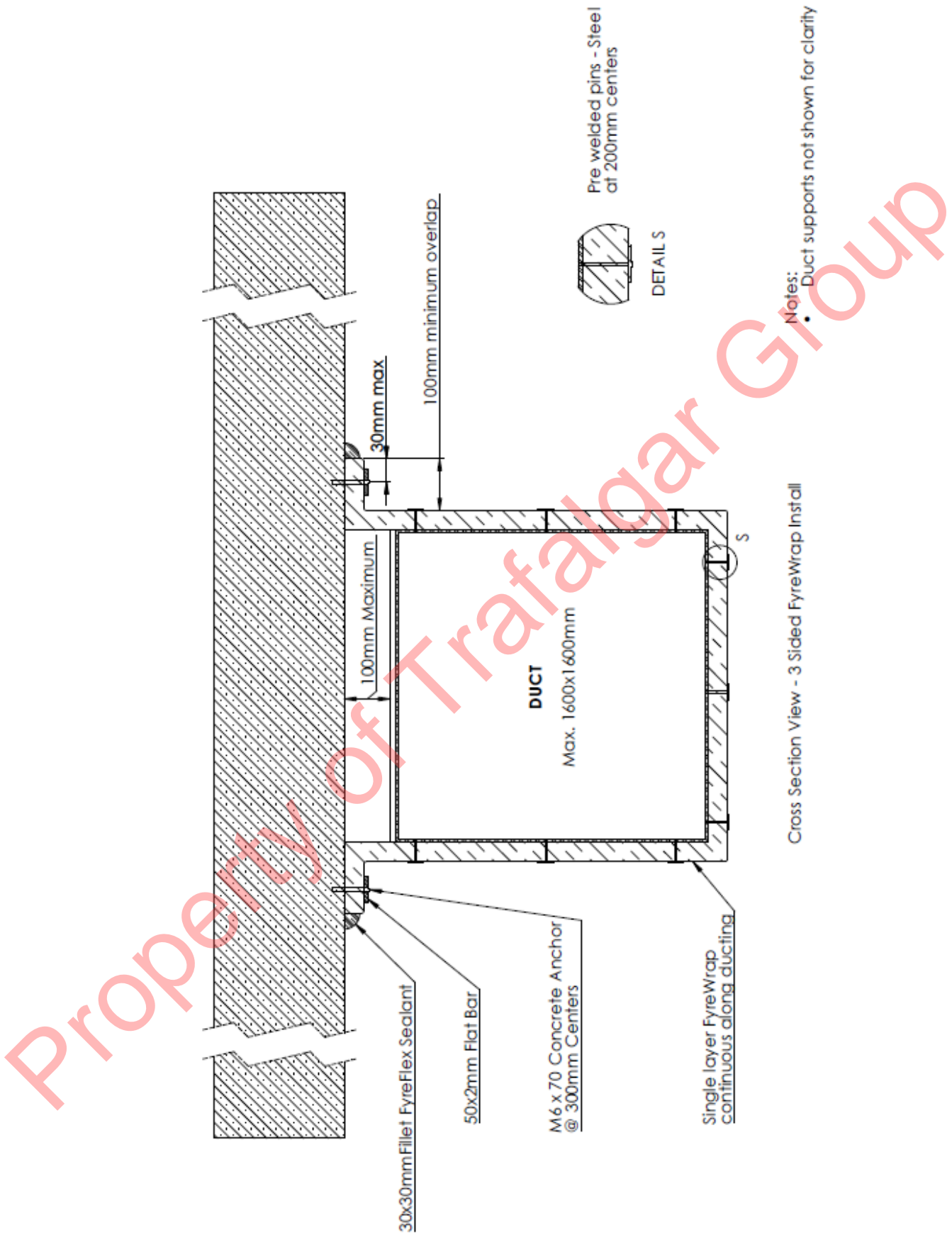

Cross Section View - 3 Sided FyreWrap Install

Figure 21 – 3 Sided Installations

Property of Wafarigat Group

Single Layer FyreWrap Overlap Specification

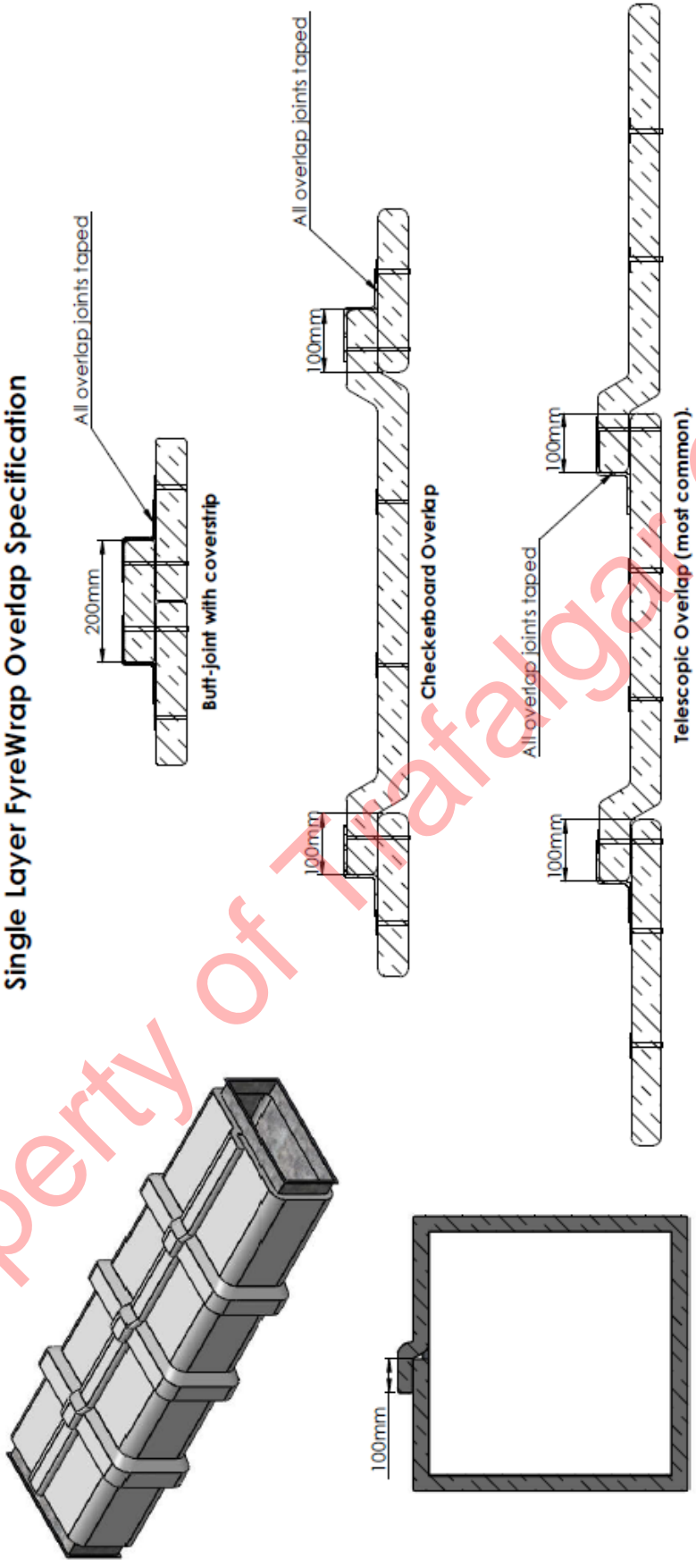

Note: All overlap Joints to be taped with 'Fyrewrap Premium Reinforced Tape'

Figure 22 – Single Layer Wrap Overlap Specification

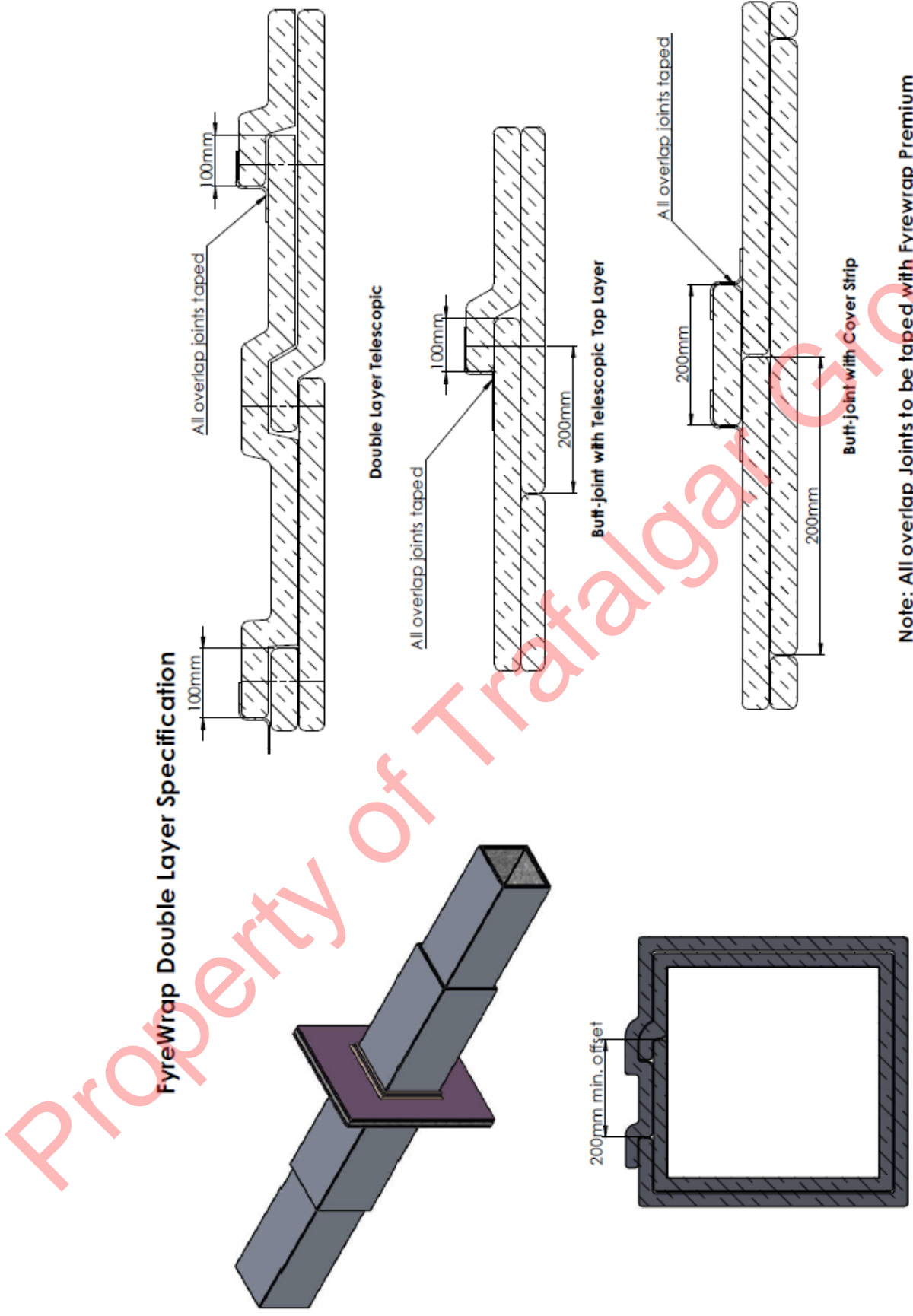

Figure 23 – Double Layer Wrap Overlap Specification

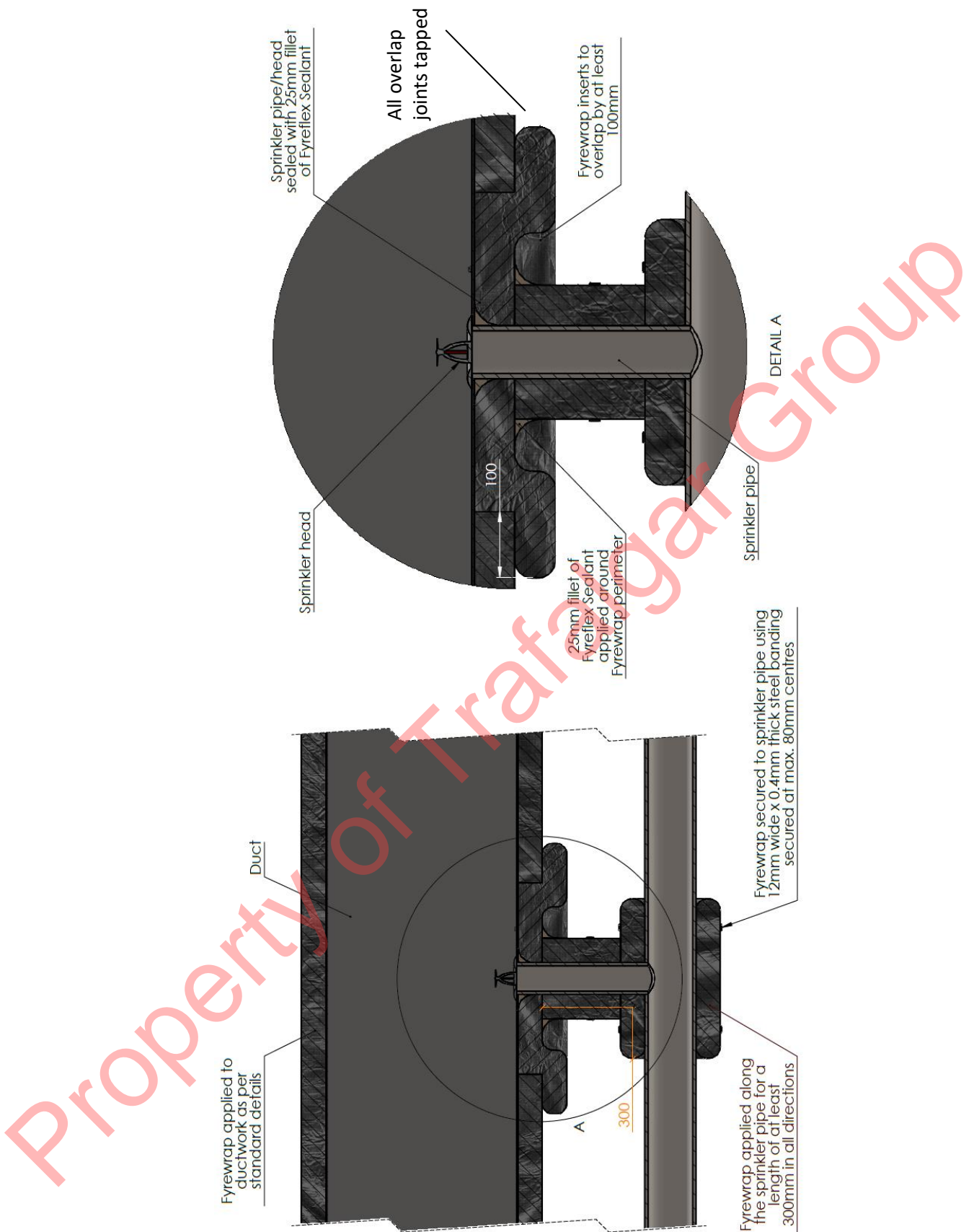

Figure 24 - Sprinkler head fitted to the face of the duct through 1 layer of FireWrap

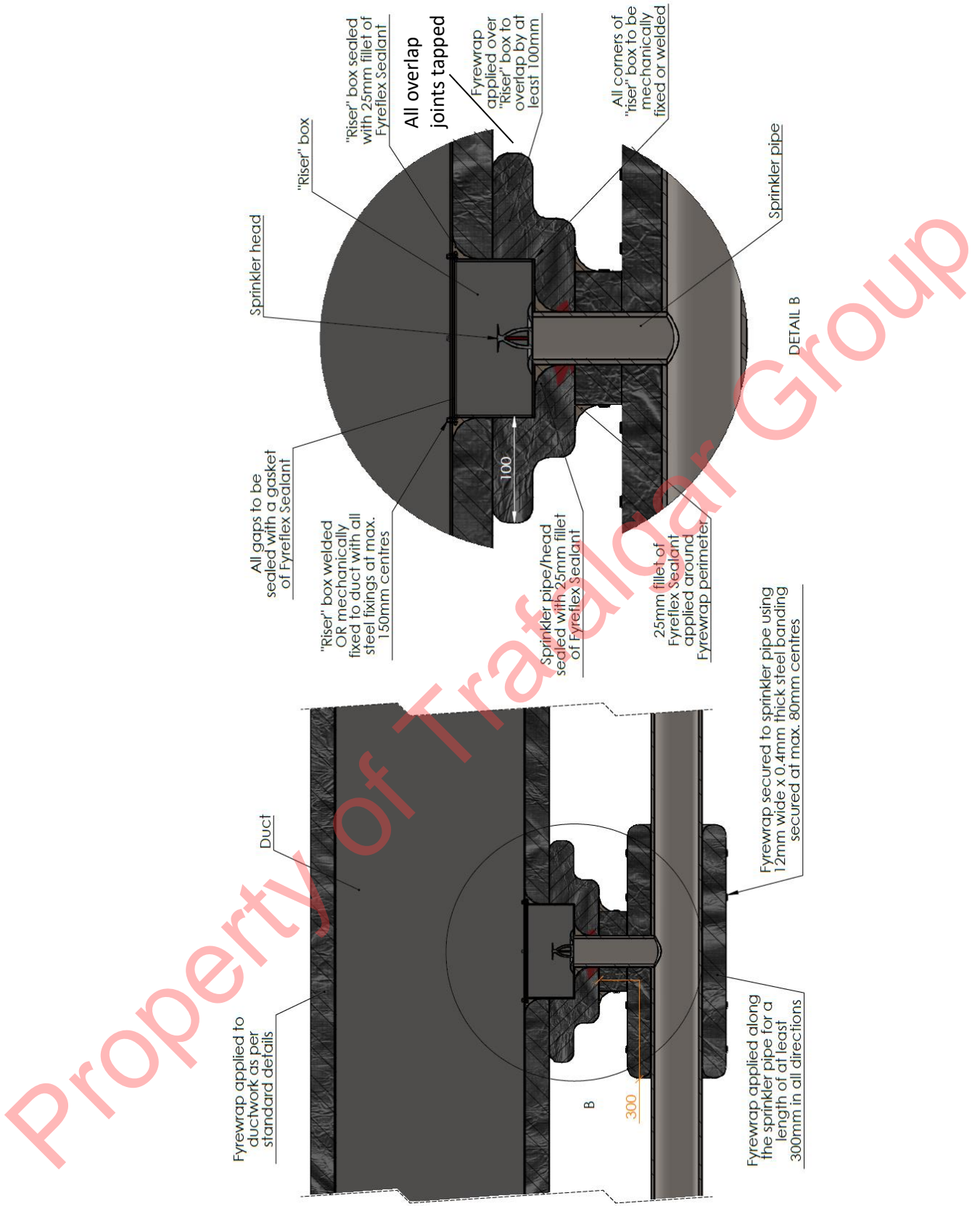

Figure 25 - Sprinkler head fitted to a riser box through 1 layer of FireWrap

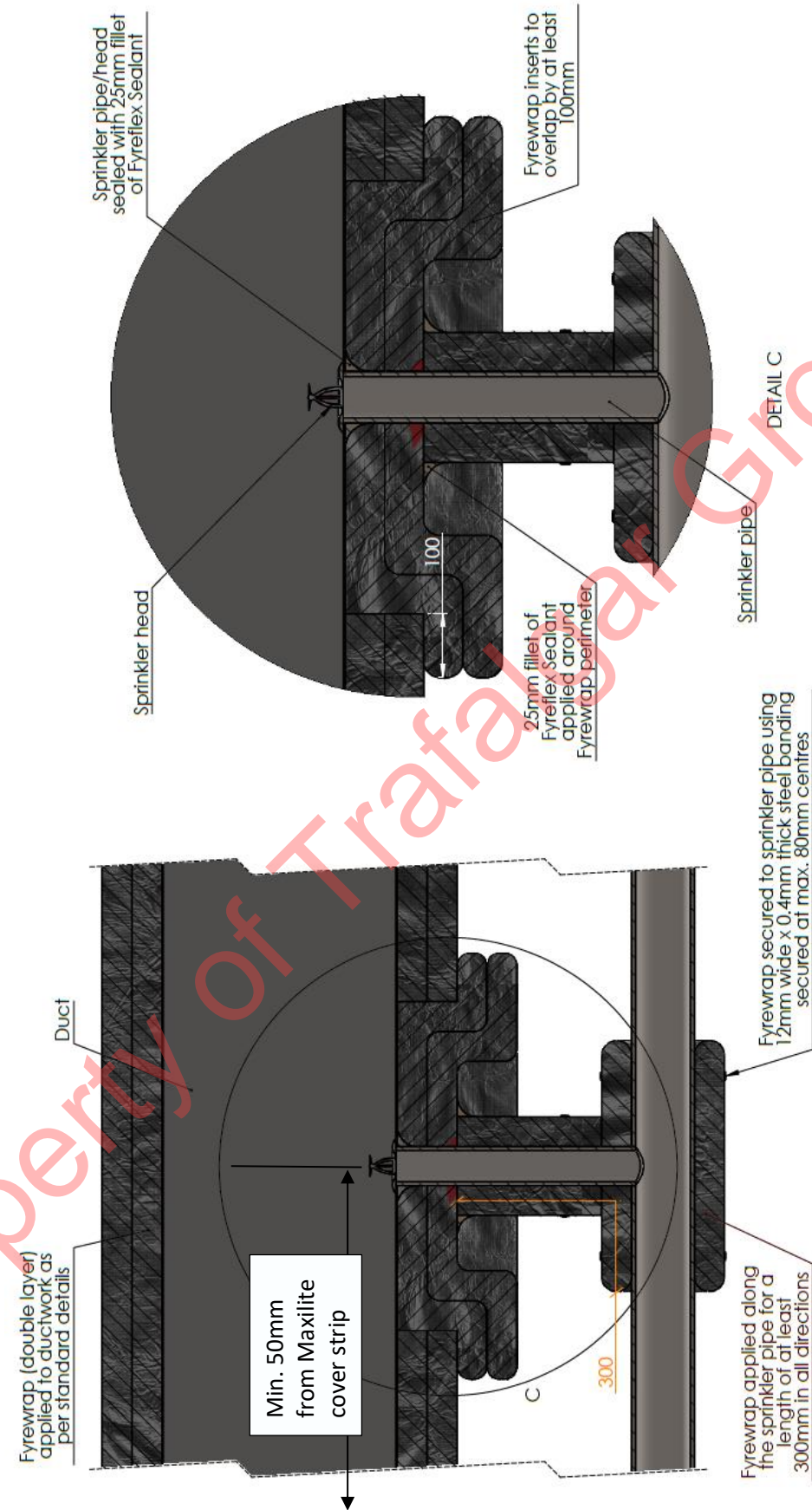

Figure 26 - Sprinkler head fitted to the face of the duct through 2 layers of FireWrap

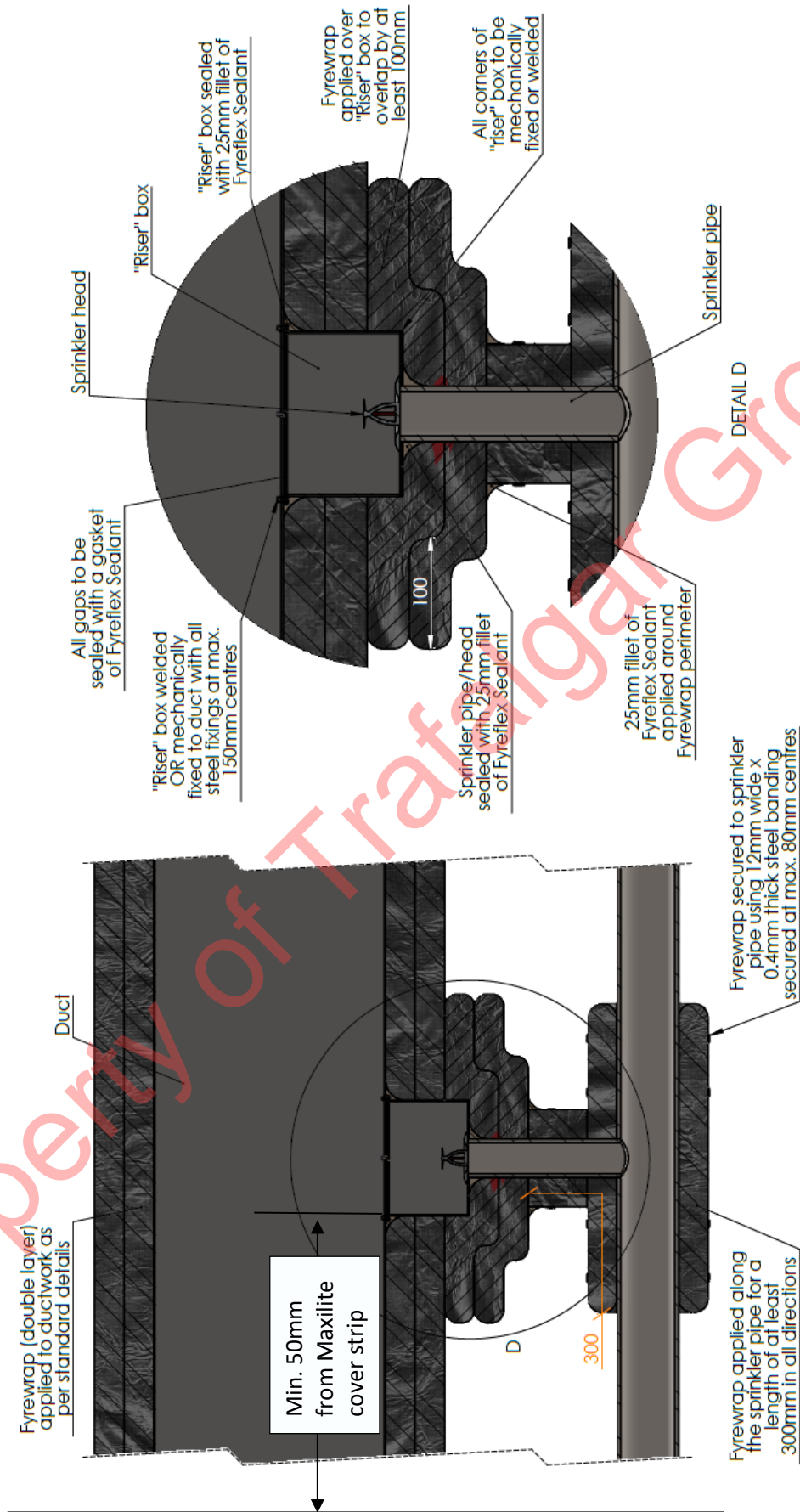

Figure 27 - Sprinkler head fitted to a riser box through 2 layers of FyreWrap

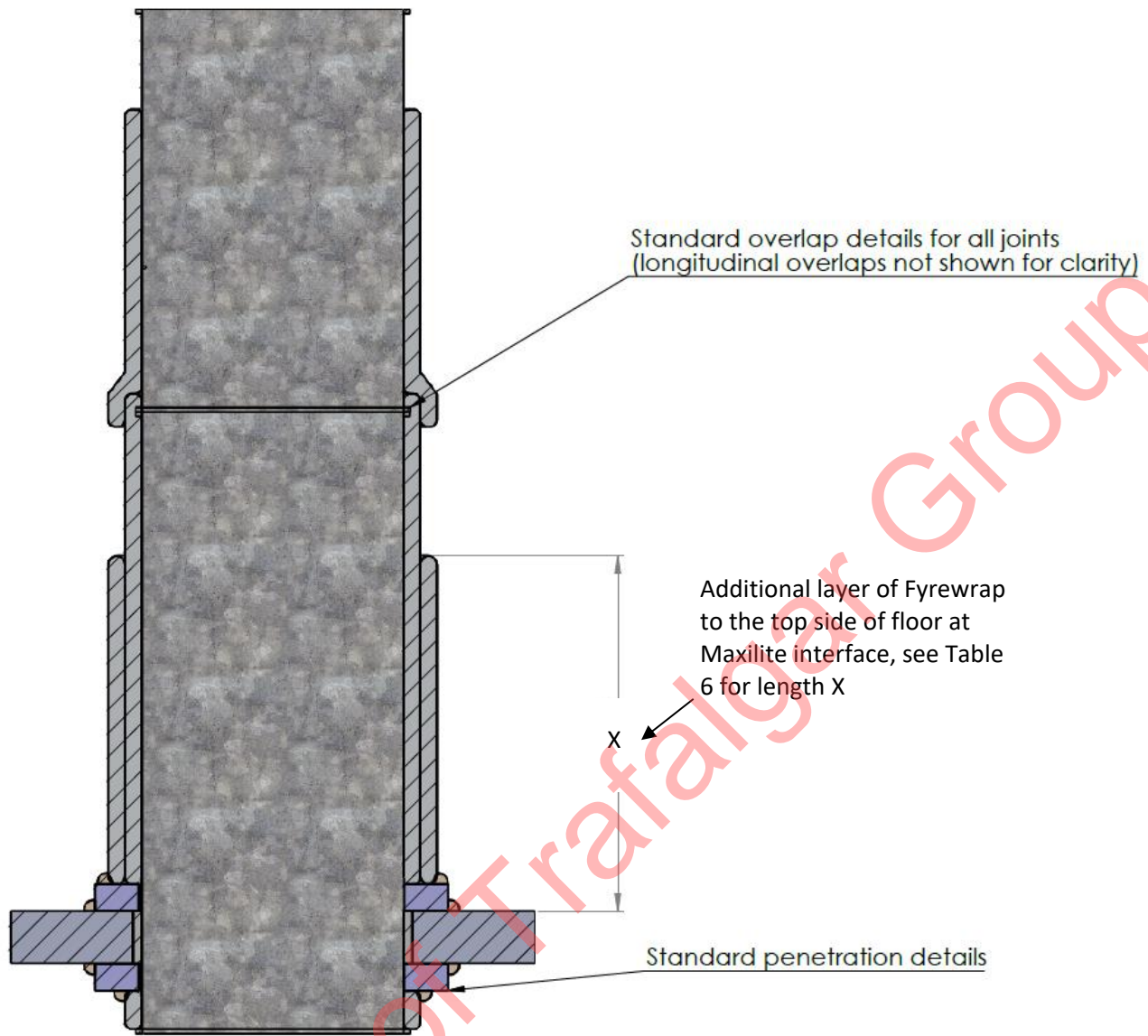

Figure 28 – Vertical duct penetration detail – 60 minute applications for ducts $\leq 600\text{mm} \times 600\text{mm}$ in size

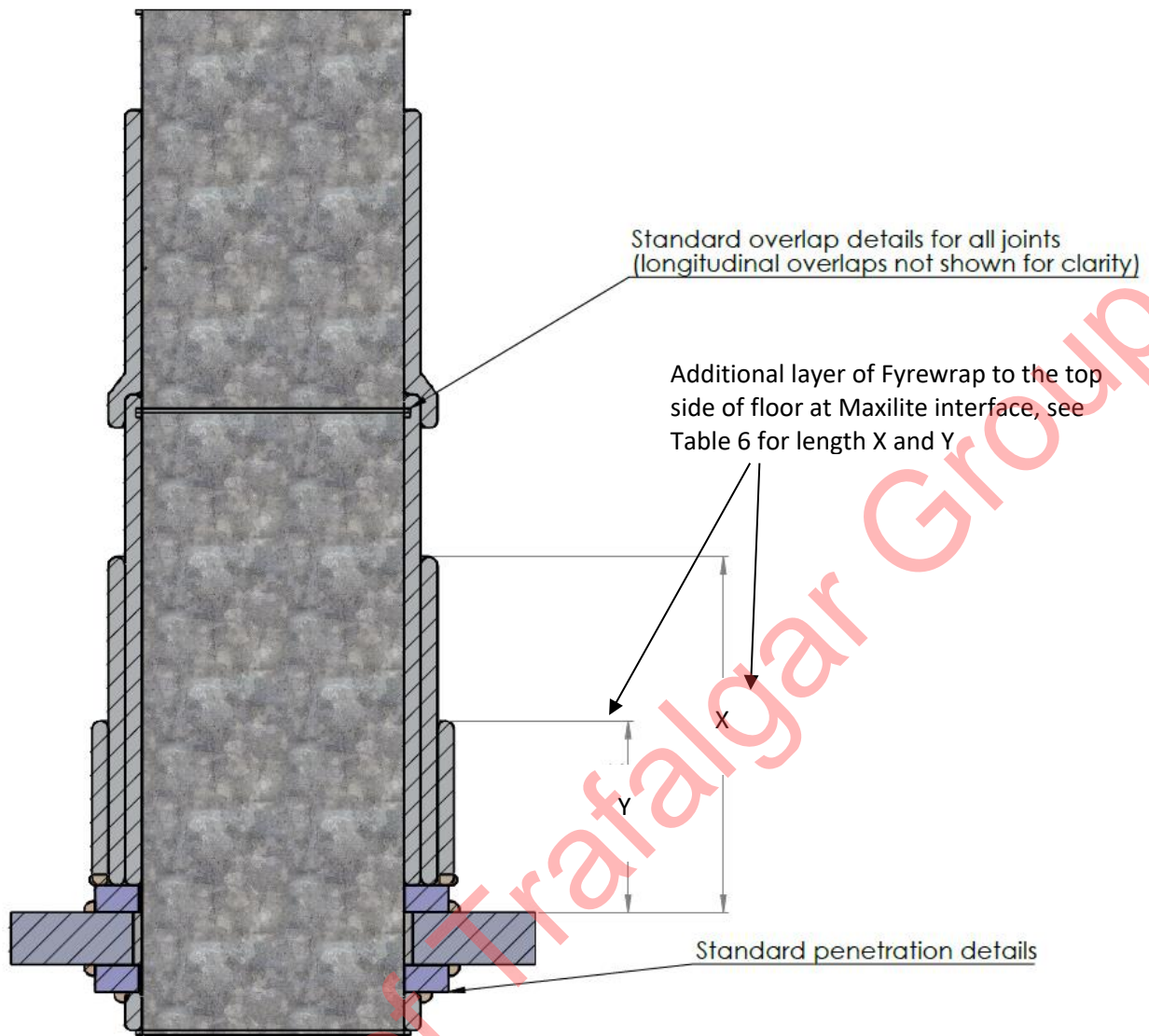

Figure 29 – Vertical duct penetration detail – 60 applications for ducts > 600mm in any dimension

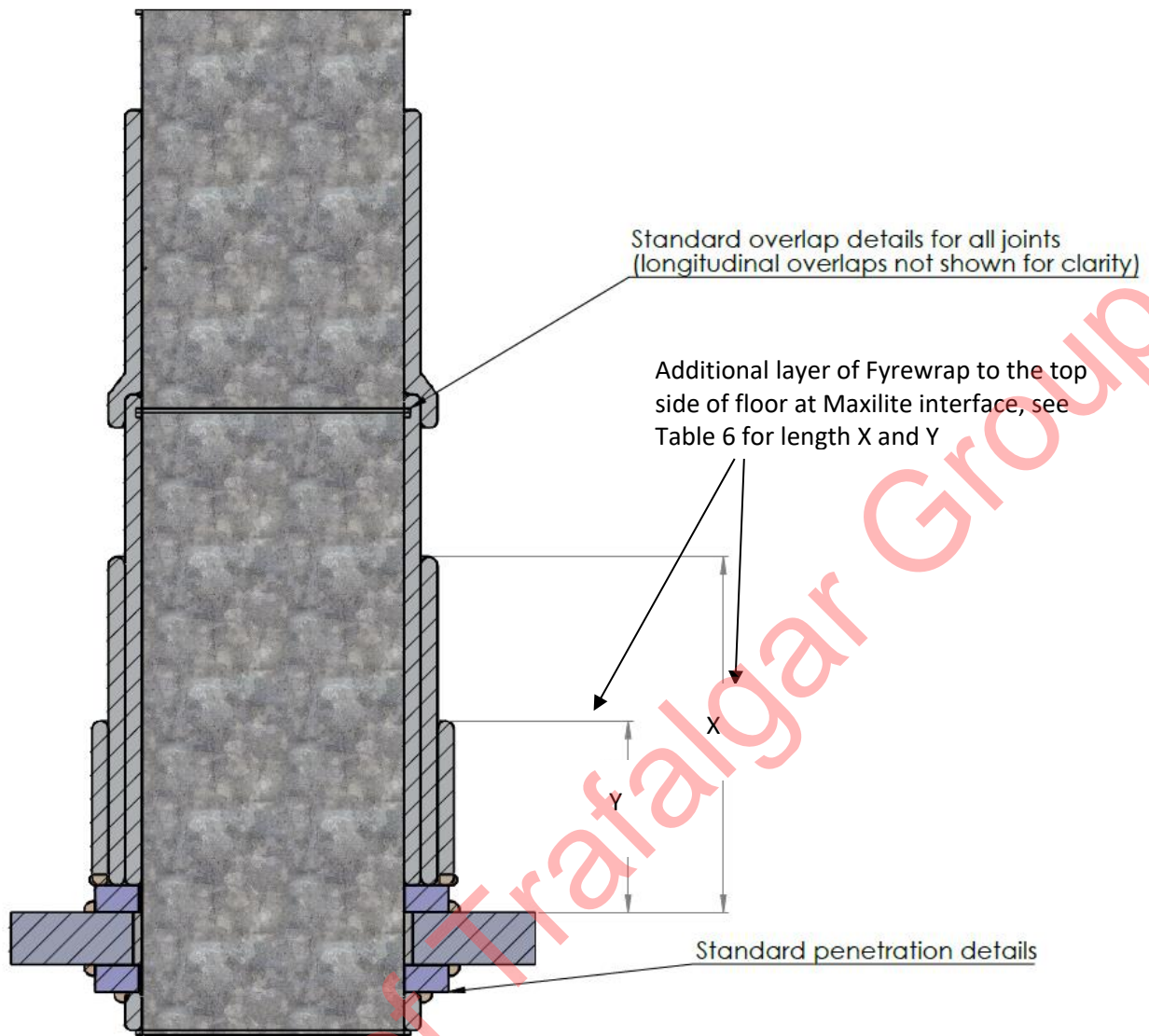
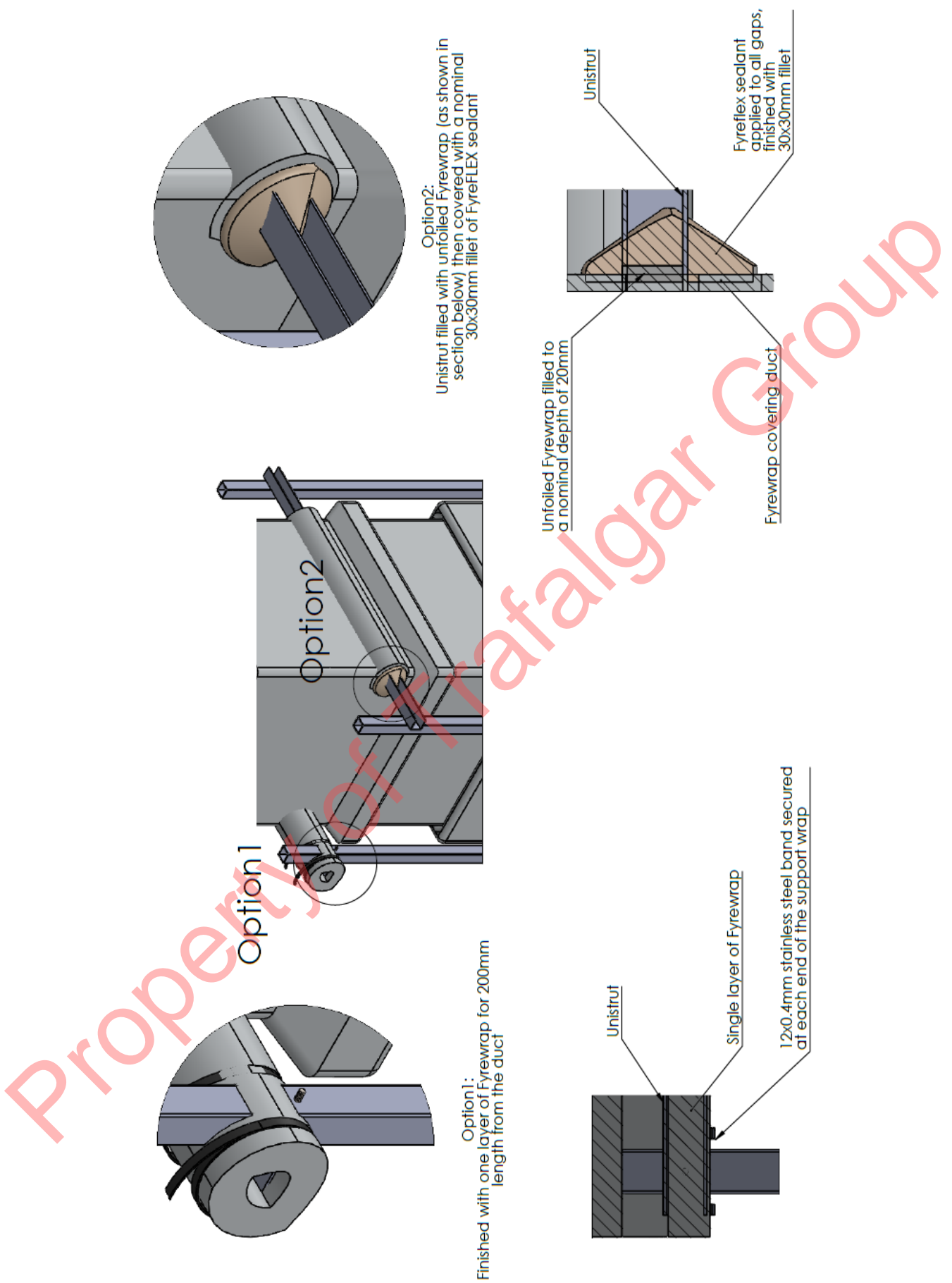

Figure 30 – Vertical duct penetration detail – 120 and 180 minute applications



Option2:
Unistrut filled with unfoiled Fyrewrap (as shown in section below) then covered with a nominal 30x30mm fillet of Fyreflex sealant

Unifoiled Fyrewrap filled to a nominal depth of 20mm

Fyreflex sealant applied to all gaps, finished with 30x30mm fillet

Option1

Option2

Option1:
Finished with one layer of Fyrewrap for 200mm length from the duct

12x0.4mm stainless steel band secured at each end of the support wrap

Figure 31 – Vertical duct support detail

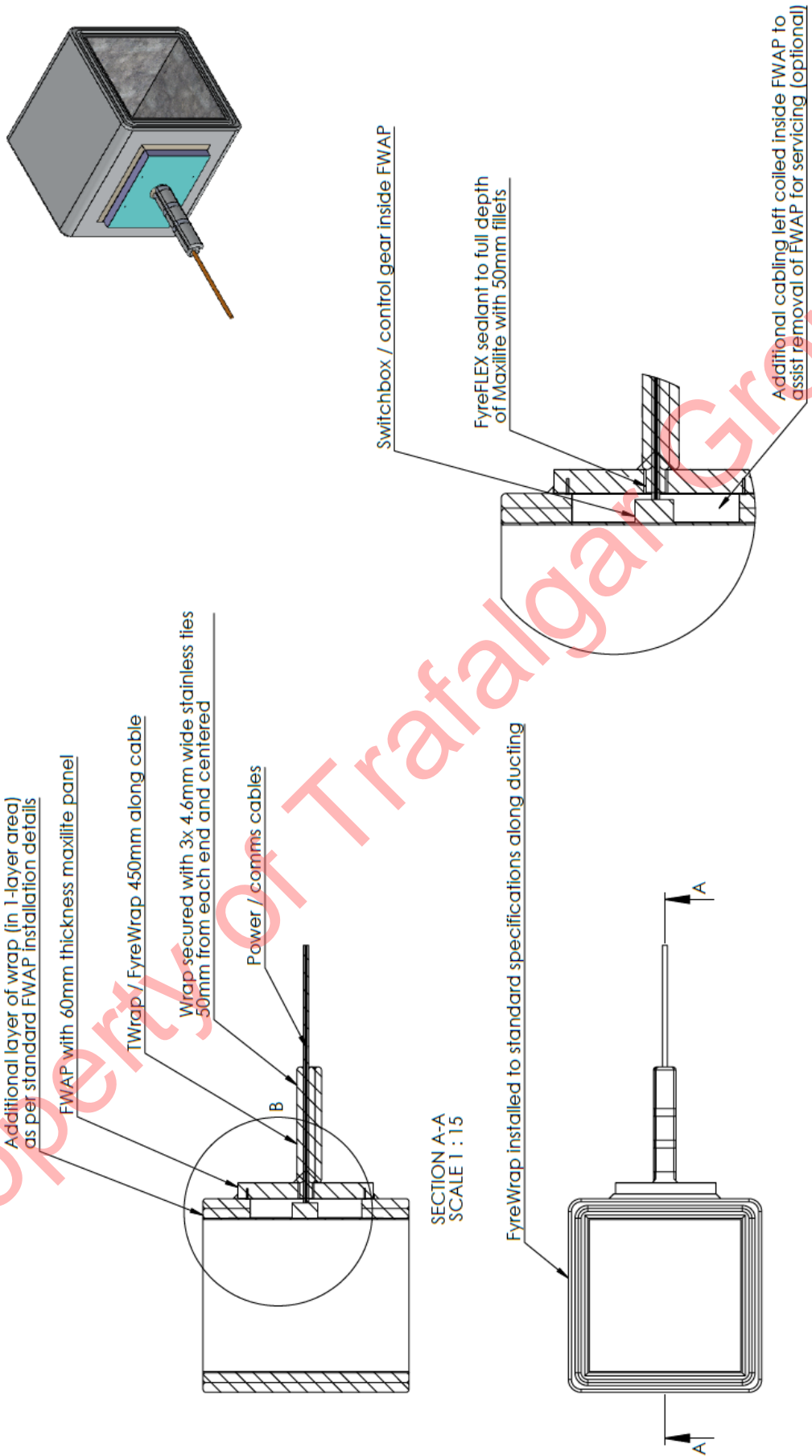

Figure 32 – Cable penetrations on one side of the duct

4 Referenced Standards

Standards:

AS1530.4-2014

Methods for fire tests on building materials, components and structures Part 4: Fire resistance tests of elements of building construction, Section 9 as appropriate for Duct protection for inside exposure.

Section 9 – As appropriate for ducts exposed to internal exposure

5 Conclusion

On the basis of the analysis presented in this report, it is the opinion of this Accredited Testing Laboratory that the tested prototypes described in Section 2 when varied as described in Section 3 will achieve the performance below when submitted to a test in accordance with the test methods referenced in Section 4, and subject to the requirements of section 7, the validity of section 8 and limitation of section 9.

Table 4 – Wrap Length VS Duct Size and FRL for horizontal ducts, wrapped on both sides

Rectangular Duct Dimension 1 (m)	Rectangular Duct Dimension 2 (m)	Length of the Second layer from wall "X" in Figures 4, 8, 12 and 16 (m)	
		FRL in both direction 60/60/60	FRL in both direction FRL 120/120/120
0.6	0.6	1.35	1.80
0.6	0.9	1.50	2.00
0.6	1.2	1.60	2.15
0.6	1.8	1.75	2.35
0.6	2.4	1.80	2.45
0.6	3	1.90	2.55
0.6	3.6	1.95	2.65
0.9	0.9	1.65	2.20
0.9	1.2	1.75	2.35
0.9	1.8	1.90	2.60
0.9	2.4	2.00	2.75
0.9	3	2.10	2.85
0.9	3.6	2.15	2.95
1.2	1.2	1.90	2.60
1.2	1.8	2.05	2.75
1.2	2.4	2.15	2.95
1.2	3	2.25	3.10
1.2	3.6	2.30	3.20
1.8	1.8	2.25	3.05
1.8	2.4	2.35	3.25
1.8	3	2.45	3.40
1.8	3.6	2.55	3.50
2.4	2.4	2.50	3.45
2.4	3	2.60	3.60

Rectangular Duct Dimension 1 (m)	Rectangular Duct Dimension 2 (m)	Length of the Second layer from wall "X" in Figures 4, 8, 12 and 16 (m)	
		FRL in both direction 60/60/60	FRL in both direction FRL 120/120/120
2.4	3.6	2.70	3.75
3	3	2.75	3.80
3	3.6	2.80	3.95
3.6	3.6	2.90	4.10

Table 5 – Wrap Length VS Duct Size and FRL for horizontal ducts, wrapped on one side

Rectangular Duct Dimension 1 (m)	Rectangular Duct Dimension 2 (m)	Length of the Second layer from wall "X" in Figure 17 (m)	
		FRL when exposed from unwrapped side only 60/60/60	FRL when exposed from unwrapped side only 120/120/120
0.6	0.6	1.35	1.80
0.6	0.9	1.50	2.00
0.6	1.2	1.60	2.15
0.6	1.8	1.75	2.35
0.6	2.4	1.80	2.45
0.6	3	1.90	2.55
0.6	3.6	1.95	2.65
0.9	0.9	1.65	2.20
0.9	1.2	1.75	2.35
0.9	1.8	1.90	2.60
0.9	2.4	2.00	2.75
0.9	3	2.10	2.85
0.9	3.6	2.15	2.95
1.2	1.2	1.90	2.60
1.2	1.8	2.05	2.75
1.2	2.4	2.15	2.95
1.2	3	2.25	3.10
1.2	3.6	2.30	3.20
1.8	1.8	2.25	3.05
1.8	2.4	2.35	3.25
1.8	3	2.45	3.40
1.8	3.6	2.55	3.50
2.4	2.4	2.50	3.45
2.4	3	2.60	3.60
2.4	3.6	2.70	3.75
3	3	2.75	3.80
3	3.6	2.80	3.95
3.6	3.6	2.90	4.10

Table 6 – Wrap Length VS Duct Size and FRL for vertical ducts

Rectangular Duct Dimension 1 (m)	Rectangular Duct Dimension 2 (m)	FRL 60/60/60	FRL 120/120/120		FRL 180/180/180	
		Length of the Second layer from wall "X" in Figures 28 and 29 (m)	Length of the Second layer from wall "X" in Figure 30 (m)	Length of the third layer from wall "Y" in Figure 30 (m)	Length of the Second layer from wall "X" in Figure 30 (m)	Length of the third layer from wall "Y" in Figure 30 (m)
0.6	0.6	0.60	2.00	-	2.15	1.10
0.6	0.9	0.70	2.40	1.20	2.60	1.30
0.6	1.2	0.75	2.55	1.25	2.70	1.40
0.6	1.8	0.80	2.80	1.35	3.00	1.50
0.6	2.4	0.85	3.00	1.40	3.20	1.60
0.6	3	0.90	3.10	1.45	3.30	1.70
0.6	3.6	0.95	3.20	1.50	3.40	1.70
0.9	0.9	1.00	2.80	1.30	2.80	1.50
0.9	1.2	1.05	2.90	1.40	3.00	1.60
0.9	1.8	1.10	3.10	1.50	3.30	1.70
0.9	2.4	1.15	3.30	1.55	3.50	1.80
0.9	3	1.20	3.40	1.60	3.70	1.80
0.9	3.6	1.25	3.55	1.65	3.80	1.80
1.2	1.2	1.30	3.10	1.50	3.20	1.60
1.2	1.8	1.35	3.40	1.60	3.60	1.80
1.2	2.4	1.40	3.50	1.65	3.80	1.90
1.2	3	1.45	3.70	1.70	4.00	1.90
1.2	3.6	1.50	3.80	1.80	4.10	2.00
1.8	1.8	1.55	3.70	1.70	3.90	2.00
1.8	2.4	1.60	3.90	1.80	4.20	2.00
1.8	3	1.65	4.10	1.85	4.40	2.10
1.8	3.6	1.70	4.20	1.90	4.60	2.20
2.4	2.4	1.75	4.20	1.95	4.60	2.30
2.4	3	1.80	4.40	2.00	4.80	2.30
2.4	3.6	1.85	4.50	2.05	4.90	2.30
3	3	1.90	4.60	2.10	5.00	2.30
3	3.6	1.95	4.80	2.15	5.20	2.40
3.6	3.6	2.00	5.20	2.20	5.40	2.50

6 Direct Field of Application of Results

The results of this assessment apply to ducts exposed to fire from inside the duct only. For vertical ducts, the relevant duct performance applies to the sections of the duct above the slab. For ducts wrapped on one side only, the relevant duct performance applies to fire exposure to the unwrapped side only.

7 Requirements

It is required the systems described above be fitted to supporting wall and floor construction that has been tested or assessed to achieve the required FRL.

Any variations concerning size, constructional details, loads, stresses, edge or end conditions that are other than those identified in this report, may invalidate the conclusions drawn in this report.

8 Term of Validity

This assessment report will lapse on 31st July 2025. Should you wish us to re-examine this report with a view to the possible extension of its term of validity, would you please apply to us three to four months before the date of expiry. This Division reserves the right at any time to amend or withdraw this assessment in the light of new knowledge.

9 Limitations

The conclusions of this assessment report may be used to directly assess the fire resistance performance under such conditions, but it should be recognised that a single test method will not provide a full assessment of the fire hazard under all fire conditions.

Because of the nature of fire resistance testing, and the consequent difficulty in quantifying the uncertainty of measurement, it is not possible to provide a stated degree of accuracy. The inherent variability in test procedures, materials and methods of construction, and installation may lead to variations in performance between elements of similar construction.

This assessment report does not provide an endorsement by CSIRO of the actual products supplied to industry. The referenced assessment can therefore only relate to the actual prototype test specimens, testing conditions and methodology described in the supporting data, and does not imply any performance abilities of constructions of subsequent manufacture.

This assessment is based on information and experience available at the time of preparation. The published procedures for the conduct of tests and the assessment of test results are the subject of constant review and improvement, and it is recommended that this report is reviewed on or, before, the stated expiry date.

The information contained in this assessment report shall not be used for the assessment of variations other than those stated in the conclusions above. The assessment is valid provided no modifications are made to the systems detailed in this report. All details of construction should be consistent with the requirements stated in the relevant test reports and all referenced documents.

Appendix A Supporting Test Data

A.1 Exova Warringtonfire Report EWFA 35343400.3

On the 12 June 2015, Exova Warringtonfire (Aus) Pty conducted a fire resistance test of a steel duct protected with FyreWrap Elite 1.5 duct insulation tested in accordance with AS 1530.4- 2014, Section 9 as appropriate for internal fire exposure.

The test assembly comprised nominally 1.2m x 1.2m plasterboard lined wall supporting a 600mm x 600mm steel duct protected externally with a layer of FyreWrap Elite 1.5 duct insulation that projected away from the unexposed side of the wall 2082mm. The duct was comprised of two 600mm wide x 600mm high 1.2m long sections and made from galvanised mild steel 1.2mm thick. The ducts were externally wrapped with 1 x layer of 40mm FyreWrap Elite 1.5 duct insulation with wrap density measured at 113kg/m³. The duct penetrated 200mm through a 640mm wide x 640mm high opening in the wall. The duct was suspended in position using 40 x 40 x 3mm struts with M10 threaded rod, square washers and nuts at locations 465mm and 1500mm from the face of the wall.

A gap nominally 20mm wide between the opening in the wall and the duct was filled with silicate wool (unfoiled FyreWrap) with the steel angle fixed to the wall at the perimeter of the duct and capped with Maxilite board. Pictures were taken during assembly below.



The furnace pressure was maintained at $15\text{Pa} \pm 2\text{Pa}$ after the first five minutes at the centre of the duct inlet. The ambient temperature at the start of the test was 15°C and varied between 15°C and 16°C during the test.

Additional Roving thermocouple readings were recorded.

Time (Minutes)	Distance from wall	A roving thermocouple was applied 15mm from steps in the wrap	Temperature
30	50	The temperature on the wrap at Maxilite board –	74°C
30	500	The temperature at 1st and 4th wrap step – (on 4th wrap)	34°C
30	1200	The temperature at 4th and 3rd wrap step – (on 3rd wrap)	90°C
30	1600	The temperature at 3rd and 2nd wrap step – (on 2nd wrap)	90°C
60	500	The temperature at 1st and 4th wrap step – (on 4th wrap)	198°C
60	1200	The temperature at 4th and 3rd wrap step – (on 3rd wrap)	200°C
60	1600	The temperature at 3rd and 2nd wrap step – (on 2nd wrap)	175°C
95	1200	Temperature at 1st and 4th wrap step – (on the 4th wrap)	223°C
98	500	The temperature at 4th and 3rd wrap step – (on 3rd wrap)	222°C
104	1600	The temperature at 3rd and 2nd wrap step – (on 2nd wrap)	183°C

Criteria	Duct Performance
Structural Adequacy	No failure at 121 minutes
Integrity	No failure at 121 minutes
Insulation	44 minutes- 25mm from wrap overlap of 1st and 2 nd wrap (location E)

A.2 CSIRO Report FSP 1307

On the 2 May 2008, CSIRO North Ryde conducted a fire test accordance with AS1530.4-2005 on an access panel screw fixed into a steel perimeter frame. The perimeter frame was fixed into an opening in a 230-mm thick masonry wall.

The steel perimeter frame was fabricated from 1.1-mm thick mild steel and incorporated a 25-mm wide architrave face which finished flush with the unexposed face of the masonry wall. The steel perimeter frame provided a nominally 750-mm x 750-mm opening for the access panel and incorporated a 30-mm wide rebate. A Lorient HP4002 intumescent seal was fitted to four sides of the perimeter frame. Each side of the perimeter frame was fitted with two M6 steel speed nuts to facilitate the fixing of the access panel.

The perimeter frame was fixed into the surrounding brick wall using 6-mm expanding masonry anchors using three fixings on each side. A reinforced concrete lintel was used to support the brickwork above the access panel perimeter frame.

The access panel measured nominally 740-mm high x 740-mm wide x 68-mm thick. The access panel was fabricated using a 60-mm thick Maxilite board core faced with a 4-mm thick MDF board. The MDF face sheeting was fixed to the Maxilite core using a contact adhesive. The access panel was fitted into the perimeter frame allowing a 5-mm clearance on all four sides. The access panel was fixed into the steel perimeter frame using 100-mm long countersunk head M6 bolts fitting into the frame mounted M6 speed nuts at nominally 250-mm centres. The Lorient HP4002 intumescent seal was located between the edge of the access panel and the perimeter frame on all four sides of the panel.

When tested the hatch achieved the following performance

Integrity – 241 minutes - no failure

Insulation in Frame – 20 minutes - maximum temperature rise limit of 180 K is exceeded on the unexposed face of the perimeter frame

Insulation in Hatch Panel – 241 minutes - no failure



A.3 BRANZ Report FR 3982

On the 17th June 2008, BRANZ conducted a fire test in accordance with AS1530.4-2005 on a vertical separating element consisting of a plasterboard wall with steel framing comprising a double layer of 16 mm thick Gyprock® Fyrcheck plasterboard on the exposed and unexposed face of the wall. The framing consisted of 64 mm deep steel studs.

The specimen included various service penetrations including an access panel fitted to a 397 mm x 397 mm aperture lined with 16mm Fyrcheck plasterboard.

The access panel comprised of a metal frame with a hinged hatch fabricated from Maxilite board. The frame was made from electro-plated mild steel nominally 1.2 mm thick. The profile of the frame was such that a flange was created measuring 28 mm which fitted against the unexposed face of the wall. The rest of the profile including the hatch rebate and stop fitted into the aperture. The overall dimensions to the edge of the flange were 450 mm square, the access panel rebate and the panel stop measured 44 mm x 16 mm respectively. Clear distance between the side and head and bottom stops was 365 mm.

The hatch included a Trafalgar intumescent strip measuring 1.65 mm thick x 20 mm wide was glued centrally to the internal face of the panel rebate.

The ambient temperature at the start of the test was 16°C and did not vary significantly throughout the duration of the test.

When tested the access panel achieved the following performance

Service	Criteria	Result
B	Integrity	Integrity failure at 121 minutes - Flaming exceeding 10 seconds
	Insulation	Insulation failure at 67 minutes - average temperature rise exceeds 140°K
Critical Observations		
67:00 Insulation failure , average temperature rise exceeds 140°K		
77:00 The facing of the access panel showed signs of charring.		
103:00 The MDF facing on the panel has charred and lifted away from the core of the hatch notably from around the escutcheon and the perimeter of the hatch.		
104:00 Intermittent flaming appeared at the top right quadrant of the panel.		
116:00 The facing of the panel had charred and fallen off the core of the panel. The top architrave was also slowly charring.		
121:00 Flaming exceeding 10 seconds in duration occurred on the top architrave. This is deemed an integrity failure in accordance with the test standard.		

A.4 Applicability of Referenced Tests to AS1530.4-2005 to AS1530.4-2014

General

The fire resistance tests FSP 1307 and FR 3982 were conducted in accordance with AS1530.4-2005. This standard differs from AS1530.4 2014 and the significance of these differences relevant to section 3 and 10 as appropriate for the access panels in walls

Specimen mounting

The differences in the AS1530.4-2005 and AS1530.4-2014 requirements in relation to the test specimen are not significant in this case.

Specimen thermocouple arrangements

The specimen thermocouple arrangements for the referenced tests are not appreciably different between AS1530.4-2005 and AS1530.4-2014.

Criteria for failure

The criteria for the referenced tests are not appreciably different between AS1530.4-2005 and AS1530.4-2014.

Conclusion

Based on the above it is confirmed the referenced test data in accordance with AS1530.4-2005 can be used to assess performance in accordance with AS1530.4-2014.

A.5 CSIRO Report FSP 1753

On the 9 June 2016, CSIRO North Ryde conducted a fire test accordance with AS1530.4-2014 on five service installations penetrating a 75-mm thick Hebel AAC panel wall system protected by various Trafalgar Fire passive fire stopping systems. Only specimen 4 is discussed in this assessment.

The wall system comprised a 75-mm thick Hebel autoclaved aerated concrete (AAC) panel wall system with an established fire resistance level (FRL) of -/90/90 as detailed in CSIRO test report FSV 0979. The

top of the wall specimen incorporated a 150-mm thick reinforced concrete slab to simulate the soffit of a floor slab.

Specimen 4 comprises a 48-mm OD steel sprinkler pipe with a wall thickness of 3.5-mm penetrating a 65mm diameter hole in a 75mm thick Hebel panel. Fyreflex Sealant was applied to a depth of 20-mm on each side of the wall and finished with a nom. 15-mm x 15-mm fillet where the pipe penetrated each side of the wall system. The Twrap insulation was finished flush with the wall and extended for 300-mm on both sides of the wall system. The Twrap 25 insulation was secured using foil tape with a 75-mm overlap.

The specimen maintain insulation and integrity for 121 minutes duration of the test.

A.6 Exova Warringtonfire Report EWFA 43330700.1

On the 19 January 2017, Exova Warringtonfire (Aus) Pty conducted a fire resistance test of a steel duct protected with FyreWrap Elite 1.5 duct insulation tested in accordance with AS 1530.4- 2014, Section 9 as appropriate for internal fire exposure.

The test assembly comprised nominally 1760mm long x 1200mm wide x 120mm thick concrete slab supporting a 600mm x 600mm steel duct protected externally with FyreWrap Elite 1.5 Duct Insulation that projected 2080mm away from the unexposed side of the slab. The duct was comprised of two 600mm wide x 600mm deep sections of duct, 1400mm long and 880mm long each, made from galvanised mild steel 0.75mm thick.

The duct was wrapped with one layer of 40mm thick FyreWrap Elite 1.5 Duct Insulation between the Maxilite board and to a height of 950mm from the slab, and from a height of 1600mm from the slab to the top of the duct. The duct was then wrapped with two layers of 40mm thick FyreWrap Elite 1.5 Duct Insulation between a height of 950mm and 1600mm from the slab.

A 2-layer FyreWrap Access Panels (FWAP) was installed over a 315mm wide x 280mm high aperture at a height of 1445mm from the slab on the duct. The 600mm wide x 500mm high x 116mm deep FWAP comprised a 362mm x 227mm non-fire-rated duct access panel protected with 30mm Maxilite door leaf faced with Duracoat laminates.

The duct penetrated 160mm through a 660mm wide x 660mm deep opening in the concrete slab. The duct was supported in position using four 40 x 40 x 3mm struts with a nominal height of 1480mm that were secured to the concrete slab at nominal 600mm wide apart x 1050mm deep apart.

A nominally 30mm wide gap between the opening in the slab and duct was sealed with steel angles fixed to the slab at the perimeter of the duct and capped with Maxilite board.

The pressure was 3Pa below the limits prescribed in the standard between the 55-60 minute period. The pressure and temperature were within the limits for rest of the test duration and due to the nature of the specimen, this under pressure is unlikely to have affected the outcome of the test. The ambient temperature at the start of the test was 27°C and varied between 27°C and 31°C during the test.

When tested, the specimen maintain integrity for the 181 minutes duration of the test and failed insulation at 57 minutes on the wrapped part of the duct.

Wrap layer	From slab	TC	Temperature (°C)			
			30min.	60min.	90min.	120min.
1 layer	105	27	85	123	186	249
	400	29	91	194	278	318
	960	32	92	173	309	367
	1700	58	67	107	177	219
	2055	48	47	65	93	112

2 layers	300	51	68	93	92	92
	550	53	80	92	93	138
	800	55	76	94	93	94
	1010	33	64	82	97	122
	1300	57	61	78	97	152

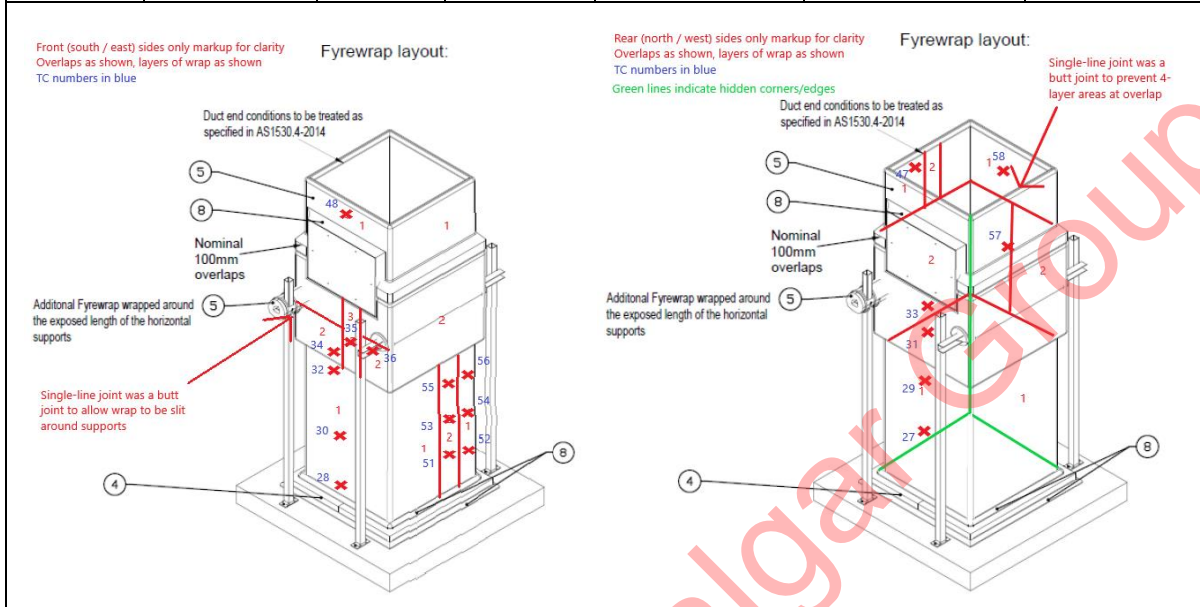

Criteria	Duct Performance
Structural Adequacy	No failure at 181 minutes
Integrity	No failure at 181 minutes
Insulation	57 minutes - on the duct wrap 300-mm from the slab (TC 52)

A.7 Exova Warringtonfire Report FRT 190292.4

On 16 January 2020, Exova Warrington Fire, VIC conducted a fire test in accordance with AS 1530.4-2014 on a 175mm thick concrete slab penetrated by various services.

specimen E1, comprised a set of Appendix D1 cables on 315mm wide x 50mm deep cable tray penetrated a 60mm thick horizontally orientated white Maxilite board and was protected with 50mm x 50mm fillets on the exposed side of the board and then wrapped in 450mm length of Twrap. Loose mineral wool was used to fill the gap between wrap and service.

The specimen did not fail integrity for 241 minutes and failed insulation at 154 minutes on the Maxilite board at the penetration. The 630mm² single core cable was able to maintain insulation for 184 minutes while the remaining cables.

Appendix B Analysis of Variations

B.1 Structural adequacy of horizontal ducts of varied size

The proposed construction shall be for ducts for internal exposure only and shall be as tested in EWFA 35343400.3 and subject to the following variations;

- Simultaneous variation of duct size, annular gap, angle size and Maxilite cover strip size as shown in Table 1.
- Duct construction shall be in accordance with AS4254-2012 Pressure Class 500. Variation to the hanger rod size, hanger spacing, support, duct BMT, stiffeners, jointing shall be in accordance with AS 4254.2-2012 as appropriate for Pressure Class 500.

Table B1 – Duct Size and Clearance Details

Duct width (mm)	Duct Height (mm)	Annular gaps -Top and bottom (mm)	Annular gaps – Sides (mm)
Up to 600	Up to 600	10-30mm	10-30mm
600-1600	600-1600	20-40mm	20-40mm
1600-2600	1600-2600	40-60mm	40-60mm
2600-3600	2600-3600	60-80mm	60-80mm

Example – A 400mm high x 1600mm wide duct requires that the opening is between 420- 460mm height and 1640-1680mm width.

Structural Adequacy

By inspection of EWFA 35343400.3, the density of FyreWrap Elite 1.5 was measured to be 113kg/m³ making the mass of one layer of 38mm thick wrap nominally 4.3kg/m² (43Pa) and supported a maximum span of 1500mm.

The duct design was 1mm steel with proprietary slip-on flanges with a 600mm cross section and a maximum of 1200mm between joints. With reference to AS 4254.2-2012 Table 2.3(C), the tested duct construction meets the Pressure Class of 500 (500Pa).

Based on inspection of the duct requirements of AS 4254 Table 2.3(C), these tables include guidance on how duct construction shall vary for larger ducts including

- A decrease in rib spacing ribs or reinforcing of duct, which means shorter duct section between joins or ribs.
- Closer supports spacing.
- Higher base metal thickness of the duct wall.
- Joints of an alternate design of greater or improved strength.

The structural resistance to internal pressure for the duct construction in AS 4254-2012 is related to the yield stress of the steel used. Based on this it is reasonable to consider that the stress state of larger ducts in accordance AS 4254-2012 with more reinforcement and thicker wall construction will have a similar stress state to smaller ducts with less reinforcement and thinner duct wall thickness.

In this assessment, it is considered reasonable and conservative that the pressure rating including the allowable support spacing is directly related to the structural adequacy of the duct when exposed to heat and no pressure when tested.

The weight of the single wrap tested, and the proposed double wrap was 43Pa and 86Pa respectively. This weight represents 1.7% and 3.4% of the pressure rating of the duct and therefore does not have a considerable impact on the structural adequacy of the duct system.

The structural adequacy of the duct, when tested, is based on the ability of the duct to resist the effects of fire and support its self-weight and that of the duct wrap protection without internal pressure or suction. The structural adequacy criteria of AS1530.4-2014 clause 9.6.1 is as follows

9.6.1 Structural adequacy

Structural adequacy failure of the duct shall be deemed to have occurred when the duct collapses in such a manner that the duct no longer fulfils its intended function.

When tested in EWFA 35343400.3 the pressure class 500 duct tested met the structural adequacy criteria without any signs of impending failure or collapse.

Based on this and the above discussion, it is considered reasonable and conservative that larger pressure class 500 ducts in accordance with AS 4254.2-2012 up to 3600mm x 3600mm will also meet this structural adequacy criterion as they include thicker metal thickness, more joint reinforcement, and lesser support spacing, all of the above making them as strong as the tested duct in its ability to span between supports and resist internal positive or negative pressure many times the weight of the wrap.

Based on the above discussion it is confirmed the proposed variation to the size of the duct construction will meet the structural adequacy requirements of AS1530.4-2014 for 120 minutes if wrapped with one or two layers of FyreWrap Elite 1.5.

Integrity and Insulation at the wall

The proposed variation to size also has consequences for the detailing of the seal of the duct protection system to the wall and the size of gaps between the duct and wall to allow for expansion.

The proposed clearances between the duct and the wall are listed in Table 1, and the minimum clearances range from 1.7% to 5% of the maximum duct cross section.

The furnace temperature at 120 minutes is 1050°C, and the calculated thermal expansion from 20°C to 1050°C is between 1.5-1.6%. It is confirmed there are sufficient gaps to allow for expansion of the duct when conservatively calculated on the furnace temperature.

The maximum proposed gap also represents an increase in the size of the gap between the ducting and the aperture in the wall. When tested this gap was filled with a layer of duct wrap with the foil removed and faced with Maxilite board. The proposed detail is similar though includes a facing of Trafalgar Fyreflex Sealant each side of the wrap (under the Maxilite board) and shown in figure 4.

The presence of the sealant on the fireside and non-fire will provide a significant increase in the fire resistant barrier to the wrap, allowing the sealant to perform in the role as a high temp gas seal, and then wrap the role of insulating and protecting the non-fire side seal. The proposed increased gaps are also protected by Maxilite boards on each side of the wall.

Based on the above discussion it is considered reasonable and conservative that the fire resistance of the proposed duct to aperture seals will be better than those tested even if the gap size increased to a maximum of 80mm.

Based on the above discussion it is confirmed that the proposed variation to the gaps around the ducts will not detrimentally affect the integrity and insulation performance when tested in accordance with AS 1530.4-2014 Section 9 as appropriate for internal exposure for up to 120 minutes.

B.2 Variation to wall construction

The proposed construction shall be for ducts for internal exposure only and shall be as tested in EWFA 35343400.3 and subject to the following variations;

- Variations previously discussed in a Section B1 of this report.
- The support construction is varied to include Speedpanel, Hebel, masonry (solid and hollow) and plasterboard lined walls as shown in Figure 1 to Figure 16 and with fixing details listed Tables 2 and 3. The support wall shall be tested or assessed by others to be suitable for the aperture size required by the duct installation.

With reference, the specimen tested in EWFA 35343400.3, which comprised a nominally 1.2m × 1.2m plasterboard lined wall 118mm wide which supported a 600mm × 600mm steel duct protected externally with a layer of FyreWrap Elite 1.5 duct insulation that projected away from the unexposed side of the wall 2082mm.

A gap nominally 20mm wide between the opening in the wall and the duct was filled with silicate wool (unfoiled FyreWrap) with steel angle fixed to the wall at the perimeter of the duct and capped with Maxilite board 60mm thick and 100mm wide.

When tested there was no loss of integrity or insulation on the face of the wall or Maxilite. There was insulation failure on the wrap and the seal of the wrap to the Maxilite, and this is discussed in Section B3 of this report.

The proposed variation to the support wall construction includes a variation of the thickness of the barrier wall and a variation to the interface of the Maxilite to the wall, though otherwise, the variation is remote from the duct and wrap.

The tested construction comprises a duct that protrudes 100mm into the furnace on the exposed side, meaning the wall thickness does not provide a significant impact on the thermal shielding to the duct.

The proposed wall construction is required to have been tested or assessed to maintain the required FRL with apertures big enough to accommodate the ducts.

The interface of the Maxilite strip with the proposed wall types is shown in Figures 1 to Figure 16. For all types, the interface includes a large bead of Fyreflex sealant between the Maxilite and duct wrap and Maxilite and wall. This will tolerate the variations in the surface shape of masonry, AAC, and Speedpanel and is expected to perform similarly to the tested plasterboard wall system.

Further confidence in this proposal is based on the addition of Fyreflex sealant over the duct gasket under the Maxilite, as discussed in Section B2 of this report.

Based on the above discussion it is confirmed the proposed variation to the support construction as shown in Figures 1-Figure 16 will not detrimentally affect the integrity and insulation performance when tested in accordance with AS 1530.4-2014 Section 9 as appropriate for internal exposure for up to 120 minutes.

B.3 Horizontal duct - Insulation performance and length of the second layer of wrap

The proposed construction shall be for ducts for internal exposure only and shall be as tested in EWFA 35343400.3 and subject to the following variations;

- Variations previously discussed in a Sections B1-B2 of this report.
- The second layer of wrap be added, and its length varied for 60 and 120-minute applications.

With reference, the specimen tested in EWFA 35343400.3 which comprised a nominally 1.2m × 1.2m plasterboard lined wall supporting a 600mm × 600mm steel duct protected externally with a layer of FyreWrap Elite 1.5 duct insulation that projected 2082mm away from the unexposed side of the wall

600mm x 600mm ducts for 60 and 120 minutes insulation

When tested in EWFA 35343400.3, the insulation performance of the wrapped part of the duct was 44 minutes. Additional measurements were taken on the wrap at other locations, and roving thermocouple readings were taken at various distances down the duct.

The measurements on an overlap adjacent to the wall maintained insulation for more than 120 minutes and verified the potential for the two layers of the wrap to achieve an insulation performance of 120 minutes adjacent to the wall.

The proposed construction includes two layers of wrap that extend along the duct from the wall for such a distance that the insulation is met by a single layer of wrap. This distance is different for 60 and 120 minutes and is based on the roving thermocouple reading taken during the test at or around 60, 90 and 120 minutes.

Based on these readings it is calculated using linear interpolation that the distance from the wall at 60 and 120 minutes is 1.35m and 1.8m respectively.

Based on the above discussion it is confirmed an insulation performance of 60 and 120 minutes will be maintained for a wrap length extension of 1.35 and 1.8m if tested in accordance with AS 1530.4-2014 Section 9 as appropriate for internal exposure.

Larger ducts for 60 and 120 minutes insulation

When tested, the 600mm duct was exposed to convective heat transfer from the air moving through the duct and due to the air being a particularly poor conductor, the temperature measured at the inlet to the duct when compared to the outlet to the duct, was nominally 160°K hotter (998°C vs 838°C at 120 minutes).

The proposed duct systems described in Figures 1-23 include a gas-tight seal at the junction with the wall construction and include all external joints tapes with FyreWrap Premium FyreWrap tape. This detailing will act to minimise the flow of hot air from the duct through the wrap system to the non-fire side, thereby further reducing the wrap temperatures.

Based on the above modification to the wrap system it is considered reasonable and conservative to calculate the impact of the change to duct size based on the “configuration factor” of the opening of the duct to the furnace. The configuration factor at any point along the duct can be calculated in accordance with AS1530.4-2014 Appendix A4 equation A4 (2), where W and H are the duct dimensions and D is the distance from the opening to the furnace. This approach ignores reflection of heat from the duct wall, though this is used in this assessment to compare small ducts to large ducts and as the small ducts also receive such reflection of heat, this factor is ignored for the purpose of this comparison.

A calculation was undertaken using the following steps

- a) For the tested 600mm x 600mm duct, interpolate the critical distance from the wall that the insulation performance is just maintained. This was found to be 1.35m and 1.8m for 60 and 120 minutes respectively.
- b) Derive the configuration factor for the tested duct at a distance down the duct at which the insulation criteria is just being maintained; this is the benchmark configuration factor.
- c) Repeat this calculation for ducts of increased size, increase the extent of wrap for the larger duct until the calculated configuration factor is less than or equal to the benchmark configuration factor.
- d) The outcome of this calculation is shown below in Table B3.

Table B2– Wrap Length VS Duct Size and FRL for Horizontal Ducts

Rectangular Duct Dimension 1 (m)	Rectangular Duct Dimension 2 (m)	Length of the Second layer from wall "X" in Figures 4, 8, 12 and 16 (m)	
		FRL 60/60/60	FRL 120/120/120
0.6	0.6	1.35	1.80
0.6	0.9	1.50	2.00
0.6	1.2	1.60	2.15
0.6	1.8	1.75	2.35
0.6	2.4	1.80	2.45
0.6	3	1.90	2.55
0.6	3.6	1.95	2.65
0.9	0.9	1.65	2.20
0.9	1.2	1.75	2.35
0.9	1.8	1.90	2.60
0.9	2.4	2.00	2.75
0.9	3	2.10	2.85
0.9	3.6	2.15	2.95
1.2	1.2	1.90	2.60
1.2	1.8	2.05	2.75
1.2	2.4	2.15	2.95
1.2	3	2.25	3.10
1.2	3.6	2.30	3.20
1.8	1.8	2.25	3.05
1.8	2.4	2.35	3.25
1.8	3	2.45	3.40
1.8	3.6	2.55	3.50
2.4	2.4	2.50	3.45
2.4	3	2.60	3.60
2.4	3.6	2.70	3.75
3	3	2.75	3.80
3	3.6	2.80	3.95
3.6	3.6	2.90	4.10

Based on the above discussion it is confirmed that the insulation performance for the proposed construction is maintained for 60 and 120 minutes for the extent of the double wrap shown in Table B3 when tested in accordance with AS 1530.4-2014 Section 9 as appropriate for internal exposure.

B.4 Structural adequacy of vertical ducts of varied size

The proposed construction shall be for ducts for internal exposure only and shall be as tested in EWFA 43330700.1 and subject to the following variations;

- Simultaneous variation of duct size, annular gap, angle size and Maxilite cover strip size as shown in Table B3.
- Duct construction shall be in accordance with AS 4254-2012 Pressure Class 500. Variation to the hanger rod size, hanger spacing, support, duct BMT, stiffeners, jointing shall be in accordance with AS 4254.2-2012 as appropriate for Pressure Class 500.

Table B3 – Duct Size and Clearance Details

Duct width (mm)	Duct Height (mm)	Annular gaps -Top and bottom (mm)	Annular gaps – Sides (mm)
Up to 600	Up to 600	10-30mm	10-30mm
600-1600	600-1600	20-40mm	20-40mm
1600-2600	1600-2600	40-60mm	40-60mm
2600-3600	2600-3600	60-80mm	60-80mm

Example – A 400mm high x 1600mm wide duct requires that the opening is between 420- 460mm height and 1640-1680mm width.

Structural Adequacy

By inspection of EWFA 43330700.1, the density of FyreWrap Elite 1.5 was measured to be 113kg/m³ making the mass of one layer of 38mm thick wrap nominally 4.3kg/m² (43Pa) and supported a maximum span of 100mm.

The duct design was 0.75mm steel with proprietary slip-on flanges with a 600mm cross section and a maximum of 1420mm between joints. With reference to AS 4254.2-2012 Table 2.3(C), the tested duct construction meets the Pressure Class of 500 (500Pa).

Based on inspection of the duct requirements of AS 4254 Table 2.3(C), these tables include guidance on how duct construction shall vary for larger ducts including

- A decrease in rib spacing ribs or reinforcing of duct, which means shorter duct section between joints or ribs.
- Closer supports spacing.
- Higher base metal thickness of the duct wall.
- Joints of an alternate design of greater or improved strength.

The structural resistance to internal pressure for the duct construction in AS 4254-2012 is related to the yield stress of the steel used. Based on this it is reasonable to consider that the stress state of larger ducts in accordance AS 4254-2012 with more reinforcement and thicker wall construction will have a similar stress state to smaller ducts with less reinforcement and thinner duct wall thickness.

In this assessment, it is considered reasonable and conservative that the pressure rating including the allowable support spacing is directly related to the structural adequacy of the duct when exposed to heat and no pressure when tested.

The weight of the single wrap tested, and the proposed double wrap was 43Pa and 86Pa respectively. This weight represents 8.6% and 17.2% of the pressure rating of the duct though as it acts axially on a

vertical duct rather than perpendicular to the duct surface as for horizontal ducts, therefore does not have a considerable impact on the structural adequacy of the duct system.

The structural adequacy of the duct, when tested, is based on the ability of the duct to resist the effects of fire and support its self-weight and that of the duct wrap protection without internal pressure or suction. The structural adequacy criteria of AS 1530.4-2014 clause 9.6.1 is as follows

9.6.1 Structural adequacy

Structural adequacy failure of the duct shall be deemed to have occurred when the duct collapses in such a manner that the duct no longer fulfils its intended function.

When tested in EWFA 43330700.1 the pressure class 500 duct tested met the structural adequacy criteria without any signs of impending failure or collapse.

Based on this and the above discussion, it is considered reasonable and conservative that larger pressure class 500 ducts in accordance with AS4254.2-2012 up to 3600mm x 3600mm will also meet this structural adequacy criterion as they include thicker metal thickness, more joint reinforcement, and lesser support spacing, all of the above making them as strong as the tested duct in its ability to span between supports and resist internal positive or negative pressure many times the weight of the wrap.

Based on the above discussion it is confirmed the proposed variation to the size of the duct construction will meet the structural adequacy requirements of AS 1530.4-2014 Section 9 as appropriate for internal exposure for 120 minutes if wrapped with one or two layers of FyreWrap Elite 1.5.

Integrity and Insulation at the wall

The proposed variation to size also has consequences for the detailing of the seal of the duct protection system to the wall and the size of gaps between the duct and wall to allow for expansion.

The proposed clearances between the duct and the wall are listed in Table B1, and the minimum clearances range from 1.7% to 5% of the maximum duct cross section.

The furnace temperature at 120 minutes is 1050°C, and the calculated thermal expansion from 20°C to 1050°C is between 1.5-1.6%. It is confirmed there are sufficient gaps to allow for expansion of the duct when conservatively calculated on the furnace temperature.

The maximum proposed gap also represents an increase in the size of the gap between the ducting and the aperture in the wall. When tested this gap was filled with a layer of duct wrap with the foil removed and faced with Maxilite board. The proposed detail is similar though includes a facing of Trafalgar Fyreflex Sealant each side of the wrap (under the Maxilite board) and shown in Figure 4.

The presence of the sealant on the fireside and non-fire will provide a significant increase in the fire resistant barrier to the wrap, allowing the sealant to perform in the role as a high temp gas seal, and then wrap the role of insulating and protecting the non-fire side seal. The proposed increased gaps are also protected by Maxilite boards on each side of the wall.

Based on the above discussion it is considered reasonable and conservative that the fire resistance of the proposed duct to aperture seals will be better than those tested even if the gap size increased to a maximum of 80mm.

Based on the above discussion it is confirmed that the proposed variation to the gaps around the ducts will not detrimentally affect the integrity and insulation performance when tested in accordance with AS 1530.4-2014 Section 9 as appropriate for internal exposure for up to 120 minutes.

B.5 Vertical duct - Insulation performance and length of the second layer of wrap

The proposed construction shall be for ducts for internal exposure only and shall be as tested in EWFA 43330700.1 and subject to the following variations;

- Variations previously discussed in a Sections B3 of this report.
- The second and third layers of the wrap are added, and its length varied for 60, 120 and 180 minute applications.

With reference, the specimen tested in EWFA 43330700.1 which comprised a nominally 1760mm long × 1200mm wide × 120mm thick concrete slab supporting a 600mm × 600mm steel duct protected externally with various layers of FyreWrap Elite 1.5 duct insulation that projected 2080mm away from the unexposed side of the slab.

600mm x 600mm ducts for 60 minute insulation

When tested in EWFA 43330700.1, the insulation performance of the wrapped part of the duct was 57 minutes. Additional measurements were taken on the wrap at other locations, and roving thermocouple readings were taken at various distances down the duct.

With 1 layer of wrap, the duct wrap was just able to maintain insulation for 60 minutes at 400mm away from the slab. The measurements on the 1 layer of duct wrap at 960mm away from the slab also maintained insulation for more than 60 minutes.

The proposed construction includes the second layer of wrap that extends along the duct from the wall for such a distance that the insulation is met by a single layer of wrap. Based on these readings it is calculated using linear interpolation that the distance from the wall at 60 minutes is 500mm.

However, it was observed that the presence of Maxilite collar at the base of the duct was acting as a heat sink during the first 60 minutes of the test as shown by its elevated temperature which plateaued at around 60 minutes.

Therefore, it is expected that the presence of the Maxilite access panel at the upper end of the duct would have acted as a heat sink to cool the specimen at that location, taking heat away from the duct system. Therefore, the wrap length is extended to 750mm to compensate for additional heat that would have been in the system without the access panel.

Based on the above discussion it is confirmed an insulation performance of 60 minutes will be maintained for a wrap length extension of 0.75m if tested in accordance with AS 1530.4-2014 Section 9 as appropriate for internal exposure.

600mm x 600mm ducts for 120 minute insulation

When tested in EWFA 43330700.1, the insulation performance of the wrapped part of the duct was 57 minutes. Additional measurements were taken on the wrap at other locations, and roving thermocouple readings were taken at various distances down the duct.

With 1 layer of wrap, the duct wrap was just able to maintain insulation for 120 minutes at 2055mm away from the slab. The measurements on 2 layer of duct wrap at 1010mm away from the slab also maintained insulation for more than 120 minutes.

The proposed construction includes the second layer of wrap that extends along the duct from the slab for such a distance that the insulation is met by a single layer of wrap. Based on these readings it is calculated using linear interpolation that the distance from the slab at 120 minutes is 1750mm.

Therefore, it is reasonable and conservative that the proposed 2000mm extension of the second layer of wrap is would be able to allow the first layer wrap to maintain insulation for up to 120 minutes.

Also, between 400mm to 960mm from the slab, the duct experienced the highest amount of radiation as shown by the rapid rise of temperature at these regions. Based on these readings it is calculated using linear interpolation that a peak temperature of 370°C would have been measured at 850mm away from the slab at 120 minutes with only one layer of wrap on the duct.

The proposed addition of the second layer to the lower end of the duct, while allowing the duct to maintain insulation, would also cause more heat to be retained in the system. This would result in the peak temperature on the first layer of the wrap to be higher than 370°C at 850mm from slab.

The effect of one additional layer of wrap at the lower end of the duct is seen in comparing the temperature of one layer of wrap and two layers of wrap at 550mm.

TC 53 located at 550mm away from slab on two layers of wrap, measured a temperature of 138°C at 120 minutes. At 550mm, the interpolation of data showed that with one layer of wrap this location would measure a temperature of 342°C at 120 minutes.

These thermocouples showed that one extra layer of wrap is able to bring down the temperature of the specimen at 120 minutes by 200°K.

Taking into consideration that the peak temperature on the one layer is higher than 370°C and to compensate for the absence of access panel that took the heat away from the duct system, the proposed second layer of wrap extending past the critical distance of 850mm will act to bring the peak temperature of this region down below 200°C for ducts up to 600mm x 600mm.

Based on the above discussion it is confirmed an insulation performance of 120 minutes will be maintained for a second layer wrap length of 2m if tested in accordance with AS 1530.4-2014 Section 9 as appropriate for internal exposure.

600mm x 600mm ducts for 180 minute insulation

When tested in EWFA 43330700.1, the insulation performance of the wrapped part of the duct was 57 minutes. Additional measurements were taken on the wrap at other locations, and roving thermocouple readings were taken at various distances down the duct.

With 1 layer of wrap, the duct wrap was able to maintain insulation for 180 minutes at 2055mm away from the slab. The measurements on 2 layer of duct wrap at 1010mm away from the slab also maintained insulation for more than 180 minutes.

The proposed construction includes the second layer of wrap that extends along the duct from the slab for such a distance that the insulation is met by a single layer of wrap. Based on these readings it is calculated using linear interpolation that the distance from the slab at 180 minutes is 1900mm.

Therefore, it is reasonable and conservative that the proposed 2150mm extension of the second layer of wrap is would be able to allow the first layer wrap to maintain insulation for up to 180 minutes.

Also, between 400mm to 960mm from the slab, the duct experienced the highest amount of radiation as shown by the rapid rise of temperature at these regions. Based on these readings it is calculated using linear interpolation that a peak temperature of 400°C would have been measured at 950mm away from the slab at 120 minutes with only one layer of wrap on the duct.

The proposed addition of the second layer to the lower end of the duct, while allowing the duct to maintain insulation, would also cause more heat to be retained in the system. This would result in the peak temperature on the first layer of the wrap to be higher than 400°C.

Taking into consideration that the peak temperature on the one layer is higher than 400°C and to compensate for the absence of access panel that took the heat away from the duct system, it is conservative therefore to introduce two additional layer of wrap extending 150mm past the critical distance of 950mm so as to bring the peak temperature of this region down below 200°C for ducts up to 600mm x 600mm.

Based on the above discussion it is confirmed an insulation performance of 180 minutes will be maintained for a second layer wrap length of 2.15m and a third layer wrap length of 1.1m if tested in accordance with AS 1530.4-2014 Section 9 as appropriate for internal exposure.

Larger ducts for 60, 120 and 180 minutes insulation

When tested, the 600mm duct was exposed to convective heat transfer from the air moving through the duct and due to the air being a particularly poor conductor, the temperature measured at the inlet to the duct when compared to the outlet to the duct was nominally hotter.

The proposed duct systems described in Figures 17-28 include a gas-tight seal at the junction with the wall construction and include all external joints tapes with FyreWrap Premium FyreWrap tape. This detailing will act to minimise the flow of hot air from the duct through the wrap system to the non-fire side, thereby further reducing the wrap temperatures.

Based on the above modification to the wrap system it is considered reasonable and conservative to calculate the impact of the change to duct size based on the “configuration factor” of the opening of the duct to the furnace. The configuration factor at any point along the duct can be calculated in accordance with AS 1530.4-2014 Appendix A4 equation A4 (2), where W and H are the duct dimensions and D is the distance from the opening to the furnace. This approach ignores reflection of heat from the duct wall, though this is used in this assessment to compare small ducts to large ducts and as the small ducts also receive such reflection of heat, this factor is ignored for the purpose of this comparison.

A calculation was undertaken using the following steps

- e) For the tested 600mm x 600mm duct, interpolate the critical distance from the wall that the insulation performance is just maintained. For 60 minutes, the critical length was found to be 0.75m on the first layer. For 120 minutes, the critical length was found to be 2m on the first layer and 1m on the second layer. For 180 minutes, the critical length was found to be 2m on the first layer and 1.1m on the second layer.
- f) Derive the configuration factor for the tested duct at a distance down the duct at which the insulation criteria is just being maintained; this is the benchmark configuration factor.
- g) Repeat this calculation for ducts of increased size, increase the extent of wrap for the larger duct until the calculated configuration factor is less than or equal to the benchmark configuration factor.
- h) The outcome of this calculation is shown below in Table B4.

Table B4– Wrap Length VS Duct Size and FRL for Vertical Ducts

Rectangular Duct Dimension 1 (m)	Rectangular Duct Dimension 2 (m)	FRL 60/60/60	FRL 120/120/120		FRL 180/180/180	
		Length of the Second layer from wall “X” in Figures 28 and 29 (m)	Length of the Second layer from wall “X” in Figure 30 (m)	Length of the third layer from wall “Y” in Figure 30 (m)	Length of the Second layer from wall “X” in Figure 30 (m)	Length of the third layer from wall “Y” in Figure 30 (m)
0.6	0.6	0.60	2.00	-	2.15	1.10
0.6	0.9	0.70	2.40	1.20	2.60	1.30
0.6	1.2	0.75	2.55	1.25	2.70	1.40
0.6	1.8	0.80	2.80	1.35	3.00	1.50
0.6	2.4	0.85	3.00	1.40	3.20	1.60
0.6	3	0.90	3.10	1.45	3.30	1.70
0.6	3.6	0.95	3.20	1.50	3.40	1.70
0.9	0.9	1.00	2.80	1.30	2.80	1.50
0.9	1.2	1.05	2.90	1.40	3.00	1.60

Rectangular Duct Dimension 1 (m)	Rectangular Duct Dimension 2 (m)	FRL 60/60/60	FRL 120/120/120		FRL 180/180/180	
		Length of the Second layer from wall "X" in Figures 28 and 29 (m)	Length of the Second layer from wall "X" in Figure 30 (m)	Length of the third layer from wall "Y" in Figure 30 (m)	Length of the Second layer from wall "X" in Figure 30 (m)	Length of the third layer from wall "Y" in Figure 30 (m)
0.9	1.8	1.10	3.10	1.50	3.30	1.70
0.9	2.4	1.15	3.30	1.55	3.50	1.80
0.9	3	1.20	3.40	1.60	3.70	1.80
0.9	3.6	1.25	3.55	1.65	3.80	1.80
1.2	1.2	1.30	3.10	1.50	3.20	1.60
1.2	1.8	1.35	3.40	1.60	3.60	1.80
1.2	2.4	1.40	3.50	1.65	3.80	1.90
1.2	3	1.45	3.70	1.70	4.00	1.90
1.2	3.6	1.50	3.80	1.80	4.10	2.00
1.8	1.8	1.55	3.70	1.70	3.90	2.00
1.8	2.4	1.60	3.90	1.80	4.20	2.00
1.8	3	1.65	4.10	1.85	4.40	2.10
1.8	3.6	1.70	4.20	1.90	4.60	2.20
2.4	2.4	1.75	4.20	1.95	4.60	2.30
2.4	3	1.80	4.40	2.00	4.80	2.30
2.4	3.6	1.85	4.50	2.05	4.90	2.30
3	3	1.90	4.60	2.10	5.00	2.30
3	3.6	1.95	4.80	2.15	5.20	2.40
3.6	3.6	2.00	5.20	2.20	5.40	2.50

B.6 Performance of ducts exposed on two or three sides

The proposed construction shall be for ducts for internal exposure only and shall be as tested in EWFA 35343400.3 and EWFA 43330700.1, and subject to the following variations;

- Variations previously discussed in a section B1-B5 of this report.
- Optional protection on 2 or 3 sides when adjacent to fire resistant non-combustible construction refer to Figure 20 and Figure 21.
- Adjacent construction shall be either non-combustible walls and floors, or walls that include combustible framing; they shall be protected by 1 x 16mm or 2 x 13mm fire grade plasterboard for 60 and 120-minute applications respectively.

Ducts exposed on only two or three sides

Where ducts are installed adjacent to the wall and floor construction that has an equal FRL to that required of the duct, it is proposed that the wrap extend to the face and be sealed to this construction as shown in Figure 20 and Figure 21.

The principle of this variation is that the duct affords protection from the wall or floor construction and that construction performs the role of the duct protection at this location. The proposed requirement of non-combustible construction or combustible construction protected with various layers of fire grade plasterboard provides confidence that the adjacent construction will not interact with the duct construction, create a cavity and support potential fires, or otherwise, behave in a manner that differs from the tested construction.

The detail of the seal of the wrap to the underside of a floor above (Figure 22) includes the following features;

- Maximum separation of the duct from the floor of 100mm.
- Fixing of each layer of the wrap to the floor construction via a 50 x 2mm flat steel bar, bolted to the floor with M6 x 70mm (min) concrete anchors at 300mm centres. Edge of wrap sealed to the floor with a 30mm x 30mm fillet of Fyreflex sealant.

The proposed construction includes a robust seal that mechanically presses the wrap in contact with the support construction, additional confidence in a continuous high temp gas seal is afforded by the fillet of Fyreflex sealant on the edge of the wrap, which will act to fill gaps at imperfections in the shape of the underside of the floor.

The gaps between the duct and floor/wall are limited to 100mm. This means the wrap is only spanning 100mm unsupported which is therefore considered the ability of the laps and joints to maintain their integrity will not be detrimentally affected.

Based on the above it is considered that the proposed details will not introduce gaps or additional venting and are of sufficient robustness to support the wrap when the duct is exposed to internal fire exposure.

Based on the above discussion it is expected that the Structural Adequacy, Integrity or Insulation performance of the proposed construction will be at least 120 minutes for horizontal ducts and 180 minutes for vertical ducts if tested in accordance with AS 1530.4-2014 Section 9 as appropriate for internal exposure.

B.7 Variation to the support systems for the ducts

The proposed construction shall be for ducts for internal exposure only and shall be as tested in EWFA 35343400.3 and EWFA 43330700.1, and subject to the following variations;

- Variations previously discussed in a Sections B1-B5 of this report.
- Duct supports such as hanger rod size; hanger spacing shall be in accordance with AS 4254.2-2012 as appropriate for Pressure Class 500.
- The weight used to calculate the force on hangers shall make due allowance for the wrapped weight and all overlaps.

The proposed construction includes hangers and supports that are specified in accordance with AS 4254-2012 as appropriate for ambient temperatures.

The test construction was exposed to internal fire exposure only and the variations described in this report confirm that the proposed construction will meet the insulation requirements of AS 1530.4-2014 at 60, 120 or 180 minutes and thereby the maximum temperature on the outside of the duct wrap is expected to be around 200°C.

By reference to AS 4100-1998 (Amdt 1) clause 12.4.1, the yield stress is not reduced until the steel temperature exceeds 215°C. It is considered based on this that there are no special requirements for the hanging rods for ducts exposed to internal fire exposure for the period that they maintain insulation.

Based on the above it is confirmed the proposed construction for duct supports will maintain the structural adequacy of the duct system for 60, 120 and 180 minutes based on the wrap designs for 60, 120 and 180 minutes insulation in accordance with AS 1530.4-2014 Section 9 as appropriate for internal exposure.

B.8 The inclusion of access panels to duct

The proposed construction shall be for ducts for internal exposure only and shall be as tested in EWFA 35343400.3 and EWFA 43330700.1, and subject to the following variations;

- Variations previously discussed in a Sections B1- B7 of this report.
- The inclusion of an access hatch detail as tested in EWFA 43330700.1, as shown in Figures 18a, 18b and 19.
- Location of hatches and supports are shown in Figure 20.

Integrity and Insulation Performance of Hatch Assembly in a horizontally orientated duct

The proposed construction includes an access panel assembly as tested in EWFA 43330700.1 installed in a horizontally orientated duct as previously discussed in a Sections B1- B7 of this report.

With reference to EWFA 43330700.1, a 600mm × 600mm vertically orientated steel duct protected externally with FyreWrap Elite 1.5 Duct Insulation contained an access panel assembly installed over a 315mm wide x 280mm high aperture at a height of 1445mm from the slab on the duct. The 600mm wide x 500mm high x 116mm deep access panel assembly comprised a 362mm × 227mm non-fire-rated duct access panel protected with 30mm Maxilite door leaf faced with Duracoat laminates. When tested, the specimen maintain integrity for the 181 minutes duration of the test and failed insulation at 57 minutes on the wrapped part of the duct. The access panel assembly did not detrimentally affect the integrity nor insulation performance of the specimen for 181 minutes.

The furnace exposure experience by a vertically orientated duct is higher than that of a horizontally orientated duct, as shown by the higher specimen temperature in EWFA 43330700.1 compared to EWFA 35343400.3. Therefore, when the access panel assembly as tested in EWFA 43330700.1 is installed in a horizontally orientated duct, it is expected to not be exposed to as much heat as it did in EWFA 43330700.1.

Based on the above discussion it is considered the integrity and insulation performance of the proposed access panels up to 550mm x 700mm will be at least 120 minutes in a horizontally orientated duct when tested in accordance with AS 1530.4-2014.

Impact of Hatch on Duct Structural Adequacy

The proposed access panel locations are within the central 1/3rd of the duct span; if located near required support, then additional support is to be provided, so the hatch is supported each side as shown in Figure 19. For applications where the hatch is in the middle 1/3rd of the duct, the shear force and compression in the duct walls are more than 50% lower at the supports. If a conservative approach is taken, the presence of the hatch could be considered to cripple one duct wall, thereby reducing the shear and buckling capacity of the duct at that section by up to 50%. As this is less than the reduction in load delay, it is considered the presence of the hatch will not weaken the duct at this location.

For the applications where the hatch is near supports, and additional support is provided, this acts to reduce the span carried by the duct wall at that location to around 40-50%. It is considered that the hatch frame, being made of steel and convoluted in shape, will act to provide a partial level of restraint to the duct wall and allow for at least 10% of the load carried at this location.

Confidence in the ability of a pressure class 500 horizontally orientated duct with an access panel assembly install on one side of its duct wall to maintain structural adequacy is shown in EWFA 43330700.1 where the pressure class 500 vertically orientated duct with an access panel assembly located within 200mm from the support strut was tested and met the structural adequacy criteria without any signs of impending failure or collapse for 181 minutes.

Based on the above discussion it is considered the structural adequacy of the horizontally orientated duct will not be detrimentally affected by the proposed access panels up to 550mm x 700mm in size for applications up to 120 minutes when tested in accordance with AS 1530.4-2014 Section 9 as appropriate for internal exposure.

B.9 The inclusion of a sprinkler system within a duct

The proposed construction shall be for ducts for internal exposure only and shall be as tested in EWFA 35343400.3 and subject to the following variations;

- Variations previously discussed in a Sections B1- B3, B6, B7 of this report.
- The inclusion of a sprinkler head fitted to the face of the duct and supplied with a steel sprinkler pipe up to 48mm OD wrapped with 300mm FyreWrap and sealed at ends of wrap with Fyreflex sealant, refer to figures 24 and 26.
- The inclusion of a sprinkler head fitted to a riser box and supplied with a steel sprinkler pipe up to 48mm OD wrapped with 300mm FyreWrap and sealed at ends of wrap with Fyreflex sealant, refer to figures 25 and 27.
- Sprinkler pipe penetration to be located at a Min. 50mm distance from the Maxilite cover strip.

A sprinkler head in the duct wall

The proposed construction comprises a sprinkler head fitted to the face of the duct and supplied with a steel sprinkler pipe up to 48mm OD wrapped with 300mm FyreWrap Elite 1.5 duct insulation and sealed at ends of wrap with Fyreflex sealant, refer to Figures 24 and 26. Sprinkler pipe penetration to be located at a Min. 50mm distance from the Maxilite cover strip at the wall penetration.

Two issues to be addressed in the proposed details are:

- The ability of the sprinkler pipe to maintain insulation when exposed to the furnace heat in the duct.
- The FyreWrap Elite 1.5 duct insulation and Fyreflex sealant seal at the penetration to allow the duct to maintain insulation and integrity.

With reference to FSP 1753 specimen 4, a 48-mm OD steel sprinkler pipe with a wall thickness of 3.5-mm penetrating a 65mm diameter hole in a 75mm thick Hebel panel. Fyreflex Sealant was applied to a depth of 20-mm on each side of the wall and finished with a nom. 15-mm x 15-mm fillet where the pipe penetrated each side of the wall system. The Twrap insulation was finished flush with the wall and extended for 300-mm on both sides of the wall system. The Twrap 25 insulation was secured using foil tape with a 75-mm overlap. The specimen maintain insulation and integrity for 121 minutes duration of the test.

The tested specimen 4 in FSP 1753 demonstrates the ability for 1 layer of 300mm long Twrap 25 insulation to a 48-mm OD steel sprinkler pipe such that it maintains insulation for 121 minutes. It also demonstrated the sufficiency of a 15-mm x 15-mm fillet of Fyreflex Sealant to seal the penetration interface between the Hebel panel and the steel sprinkler pipe such that it maintains integrity for 121 minutes.

The proposed details are similar to the unexposed side of the tested specimen 4 in FSP 1753, except it has FyreWrap Elite 1.5 duct insulation wrapping the metal pipe instead of Twrap 25 insulation. Instead of penetrating a 75mm Hebel panel, the steel pipe is penetrating the duct wall protected by layers of FyreWrap Elite 1.5 duct insulation as shown in Figures 24 and 26. Also instead of having 15-mm x 15-mm fillet of sealants on each side of the penetration, the proposed details only have 25-mm x 25-mm fillet of sealants on the exposed side of the penetration.

FyreWrap Elite 1.5 duct insulation is thicker and of lower density than Twrap 25 insulation. The significance of this is that it is considered to have had equal or better insulation resistance than Twrap 25 insulation. Therefore based on the performance of Twrap 25 insulation in FSP 1753 specimen 4, it is expected that FyreWrap Elite 1.5 duct insulation will allow the proposed steel pipe to maintain insulation for up to 120 minutes when installed in the same manner as Twrap 25 insulation in FSP 1753 specimen 4.

With reference to the discussion in the section B3, the location at which the proposed sprinkler pipe penetrates one layer of FyreWrap Elite 1.5 duct insulation only requires one layer of FyreWrap Elite 1.5 duct insulation to allow the duct to maintain insulation for up to 120 minutes. The proposed penetration treatment as shown in figure 24 has two layers of FyreWrap Elite 1.5 duct insulation, which be more than sufficient in allowing the duct at the location of the penetration to maintain insulation for 120 minutes.

Similarly, the proposed penetration treatment as shown in Figure 26 has four layers of FyreWrap Elite 1.5 duct insulation, which be more than sufficient in allowing the duct at the location of the penetration to maintain insulation for 120 minutes.

The proposed 100mm overlap between the layers FyreWrap Elite 1.5 duct insulation detail around the sprinkler pipe is as tested in EWFA 35343400.3, which as discussed in section B3 allows the duct to maintain insulation for 120 minutes. The presence of the 25mm fillet of sealant on the fireside between the FyreWrap Elite 1.5 duct insulation and the steel sprinkler pipe as well as the 25mm fillet of sealant between the layers of the FyreWrap Elite 1.5 duct insulation will provide a significant increase in the fire resistant barrier to the wrap, allowing the sealant to perform in the role as a high temp gas seal, and the wrap to perform the role of insulating and protecting the non-fire side seal.

Further confidence in the integrity performance of the sealant and wrap at this penetration is given by the lower furnace exposure which the metal sprinkler pipe in the proposed construction will experience compared to that tested in FSP 1753, which did not see any integrity failure for up to 121 minutes.

Based on the above, it is expected that the proposed construction will not detrimentally affect the integrity and insulation performance of the duct for up to 120 minutes when tested in accordance with AS 1530.4-2014 Section 9 as appropriate for internal exposure.

A sprinkler head in riser box

The proposed construction comprises a sprinkler head fitted to a riser box and supplied with a steel sprinkler pipe up to 48mm OD wrapped with 300mm FyreWrap Elite 1.5 duct insulation and sealed at ends of wrap with Fyreflex sealant, refer to Figure 25 and 27. Sprinkler pipe penetration to be located at a Min. 50mm distance from Maxilite cover strip at the wall penetration.

These details are less onerous for the insulation performance of the steel pipe compared to the detail in Figures 24 and 26 as discussed above, since the steel sprinkler pipe sits below the main airflow path of the duct and thus would be exposed to less of the furnace heat compared to the details in Figures 24 and 26. It is therefore expected that the steel sprinkler pipe wrapped in 1 layer of 300mm FyreWrap Elite 1.5 duct insulation will maintain insulation for up to 120 minutes.

However, these details are more onerous for the integrity performance of the duct compared to the detail in Figures 24 and 26 since they introduce more surface for leakage of furnace gas which can go into the layers between the FyreWrap Elite 1.5 duct insulation and go through to the unexposed face.

The sealant details between the riser box and the FyreWrap Elite 1.5 duct insulation in these two proposed details are the same as the sealant details between the steel sprinkler pipe in Figures 24 and 26, which as discussed above, which would allow the duct to maintain integrity for 120 minutes at the penetration.

The additional 25mm fillet of Fyreflex sealant applied around the FyreWrap Elite 1.5 duct insulation perimeter as shown in Figures 25 and 27 would prevent the venting of any hot gas that might ingress through the interface between the sprinkler pipe and the FyreWrap Elite 1.5 duct insulation interface.

Further confidence in the integrity performance of the sealant and wrap at this penetration is given by the lower furnace exposure which the metal sprinkler pipe in the proposed construction will experience compared to that tested in FSP 1753, which did not see any integrity failure for up to 121 minutes.

Based on the above, it is expected that the proposed construction will not detrimentally affect the integrity and insulation performance of the duct for up to 120 minutes when tested in accordance with AS 1530.4-2014 Section 9 as appropriate for internal exposure.

B.10 The inclusion of cable penetrations

The proposed construction shall be for ducts for internal exposure only and shall be as tested in EWFA 35343400.3 and EWFA 43330700.1 and subject to the following variations;

- Inclusion of cable penetration as tested in FRT 190292.4 Specimen 1, protected by 60mm thick Maxilite board and the unexposed side of the duct wall as shown in Figure 32.

With reference to FRT 190292.4 specimen E1, a set of Appendix D1 cables on 315mm wide x 50mm deep cable tray penetrated a 60mm thick horizontally orientated white Maxilite board and was protected with 50mm x 50mm fillets on the exposed side of the board and then wrapped in 450mm length of Twrap. Loose mineral wool was used to fill the gap between wrap and service. The specimen did not fail integrity for 241 minutes and failed insulation at 154 minutes on the Maxilite board at the penetration. The 630mm² single core cable was able to maintain insulation for 184 minutes while the remaining cables.

The support construction in FRT 190292.4 specimen E1 was a 175mm thick concrete slab. The proposed construction comprises the concrete slab substrate be substitute with a duct wall of a duct as described in sections B1 – B9.

The position of the proposed cable penetration is on the side of the duct wall, which would experience less furnace exposure than the horizontal position it was tested in FRT 190292.4 specimen E1. Therefore it is expected that when Maxilite board and cables in FRT 190292.4 specimen E1 is installed onto the side of a duct as illustrated in Figure 32, it will experience slightly less onerous conditions than that tested in FRT 190292.4 specimen E1.

Based on the above, it is expected that the proposed construction will not detrimentally affect the integrity and insulation performance of the duct for up to 180 minutes when tested in accordance with AS 1530.4-2014 Section 9 as appropriate for internal exposure.

CONTACT US

t 1300 363 400
+61 3 9545 2176
e enquiries@csiro.au
w www.csiro.au

YOUR CSIRO

Australia is founding its future on science and innovation. Its national science agency, CSIRO, is a powerhouse of ideas, technologies and skills for building prosperity, growth, health and sustainability. It serves governments, industries, business and communities across the nation.

FOR FURTHER INFORMATION

Infrastructure Technologies
Keith Nicholls
Team Leader - Fire Assessments
t +61 2 94905450
e keith.nicholls@csiro.au
w <https://research.csiro.au/infratech/fire-safety/fire-testing/>

Infrastructure Technologies
Brett Roddy
Group Leader | Infrastructure Technologies North Ryde
t +61 2 94905449
e brett.rodny@csiro.au
w <https://research.csiro.au/infratech/fire-safety/fire-testing/>

Property of Trafalgar Group