



MONOKOTE STEEL PROTECTION

MONOKOTE® is an industry-leading fireproofing fire spray for the protection of structural steel which brings with it over 50 years of proven performance in the field.

It's easy for contractors to apply and it is backed by Trafalgar's technical and field support specialists. This ensures that no matter how a building gets built, MONOKOTE® fireproofing will offer the highest grade of performance.

AS4100 compliant.
Including Regression
Analysis Data.



KEY FEATURES



- Vermiculite Free
- Fast, efficient application
- FRL's up to 240 minutes
- Competitive spray thicknesses
- Low VOC
- Small Coatbacks for secondary steel
- Interfaces with FyreSPRAY fire board
- UL tested/listed factory
- Regression data as per NCC & AS4100
- Special formulations available for weather exposed and corrosive environments

APPLICATIONS



- Steel structural fire proofing
- 4 hour FRLs
 - Beams, columns, etc.
 - SHS, RHS, CHS
 - Angles, plates & shelf angles
 - Widest range of steel sizes
- Covering Hp/A up to 365m⁻¹
- Large range of limiting temperatures

TRADES



TABLE OF CONTENTS



Content		Page
Overview - Trafalgar FyreSPRAY		1
What is Monokote?		3
Structural Steel Fire Protection		4
Steel Section Factor (Hp/A)		5
System FRL Approvals		6
Installation	Identify steel type and size, determine the FRL and determine the FyreSPRAY thickness	7
	Product Range	8
FRL	Thickness of Monokote MK6 H/Y for FRL- Beams	9
	Thickness of Monokote MK6 H/Y for FRL- Columns	10
FRL Tables - 620 Degrees	Universal Beams- 620 Degrees	12
	Universal Columns- 620 Degrees	13
	Parallel Flange Channels- 620 Degrees	14
	Parallel Flange Channels- 620 Degrees	15
	Unequal Angles - 620 Degrees	16
	Equal Angles- 620 Degrees	17
	Welded Beams- 620 Degrees	18
	Welded Columns- 620 Degrees	19
	Square Hollow Sections - 620 Degrees	20
	Rectangular Hollow Sections- 620 Degrees	21
	FRL Tables - 550 Degrees	Universal Beams - 550 Degrees
Universal Columns- 550 Degrees		23
Parallel Flange Channels- 550 Degrees		24
Unequal Angles - 550 Degrees		25
Equal Angles- 550 Degrees		26
Welded Beams- 550 Degrees		27
Welded Columns- 550 Degrees		28
Square Hollow Sections- 550 Degrees		29
Rectangular Hollow Sections- 550 Degrees	30	
	Circular Hollow Sections- 550 Degrees	31
Appendix	Technical Drawings	32

WHAT IS MONOKOTE®?

MONOKOTE® MK-6 HY is a single component, VERMICULITE FREE fire spray that provides a cost-effective solution to fire rating of structural steel. The material is supplied in sustainable 21.9kg packaging, and has a high yield (HY) when mixed and sprayed correctly. Monokote steel protection systems are thoroughly fire tested to comply with the strict AS4100 requirements, and is NCC approved for use to protect structural steel when exposed to fire conditions.



APPROVED STEEL SECTIONS

- Beams
 - ◇ Universal Beam
 - ◇ Welded Beam
 - ◇ Tapered flange channel
 - ◇ Parallel flange channel

- Columns
 - ◇ Universal Column
 - ◇ Circular Hollow Section
 - ◇ Square Hollow Section
 - ◇ Rectangular Hollow Section
 - ◇ Equal Angle (and unequal angle)

For other sections not listed contact Trafalgar Fire at technical@tgroup.com.au.

DESIGNED FOR CONTRACTORS

MONOKOTE® has been specifically designed to be contractor friendly. The materials are typically spray-applied, and can be pumped easily into the upper floors of tall buildings. In addition to being less abrasive and less challenging to pump, users can also elect to inject MONOKOTE® accelerator to impact set time and density of the material.

GLOBAL REPUTATION

Based on its easy-to-use characteristics, global reputation and 50-year proven history, MONOKOTE® has been employed in some of the world's biggest projects. The MGM City Center in Las Vegas, the world's largest privately funded construction project, employed over 500,000 bags of MONOKOTE® fire spray. Likewise, the architects of Singapore's Keppel Bay Bridge and New York City's own Freedom Tower have each specified MONOKOTE® products to keep their buildings safe.

Trafalgar Group are proud to bring this technology, backed with Australian Standard fire testing and industry leading local support, to the Australian market.

STRUCTURAL STEEL FIRE PROTECTION

While structural steel members do not directly contribute to the spread of fire, it is important to protect them. This is because under the heat of a fire the steel can start to lose its strength, which causes bending and twisting that can compound across a building, compromising the entire building's integrity. To avoid the potential collapse of a building, AS4100 dictates that structural steel members should be protected against the effect of fire, by limiting the heat rise of the structural member.

Depending on the site and building requirements, an FRL will be given for the steel members. This FRL will be, for example, 120/-/-. For structural steel the usual integrity and insulation criteria seen in the passive fire industry does not apply, instead only a structural adequacy figure is given (displayed in minutes).



This FRL given dictates the time that the steel member is required to remain under a certain critical temperature. This critical temperature is commonly accepted to be 550°C for columns and 620°C for beams. The factors that will determine how long a steel member can remain under this critical temperature are; the thickness and quality of the fire proofing material, and dimensions of the steel member.

FUNDAMENTALS OF STEEL PROTECTION

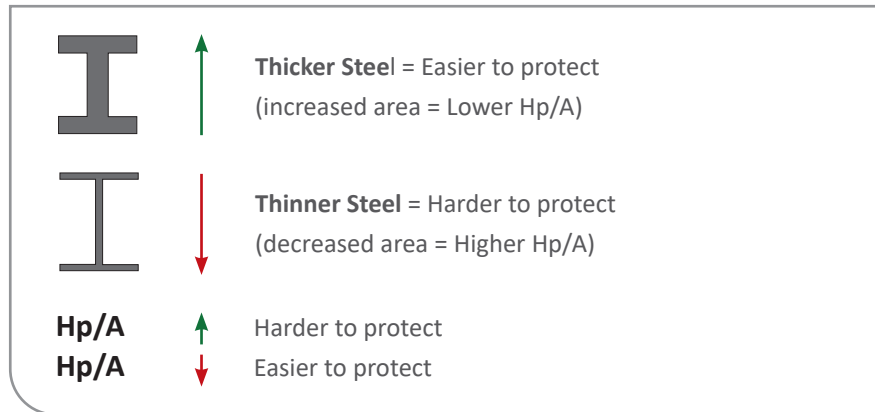

Based on data from the fire testing, we can determine the thickness of material required to keep the steel member under the critical temperature for period of the given FRL, depending on the section factor of the member (see below for details on section factor).

STEEL SECTION FACTOR (HP/A)

The steel section factor is defined as the heated perimeter (Hp) divided by its cross-sectional area (A). For spray materials this means the full perimeter of the steel member that will be exposed to the fire, divided by the cross-sectional area of the steel member. See below example.

Heated perimeter:

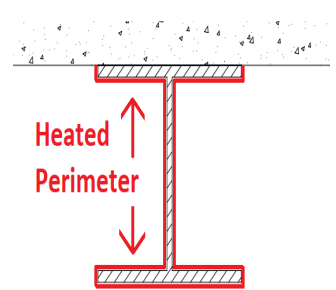
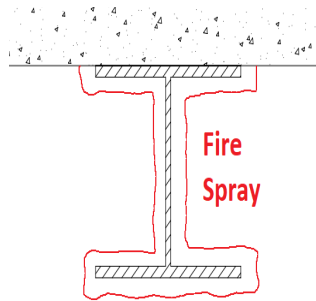
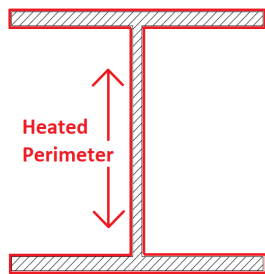
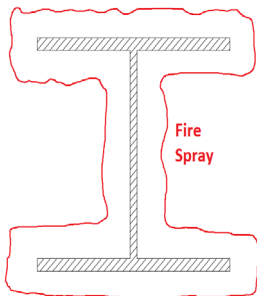

For 4-sided spray applications the heated perimeter should be calculated by adding up all of the sides of the steel including the webs and flanges as shown above.

For 3-sided spray applications the heated perimeter should be calculated by adding up all of the sides of the steel including the webs and flanges as shown above EXCEPT for the side that is adjacent to the concrete/masonry element.

Example:

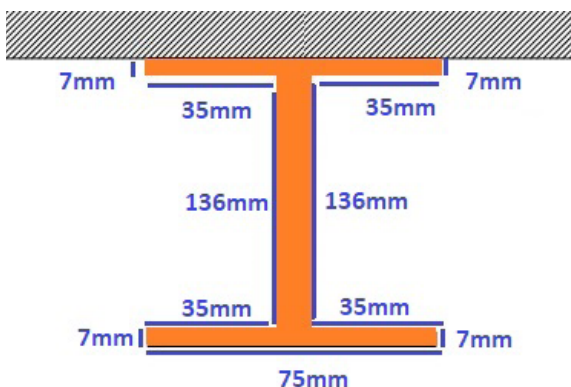

Take the beam to the left, for instance a 150UB (14).

The given cross-sectional area (orange) for this is 0.00173m².

Because the steel is installed against concrete this is what's called a '3-sided' application, where the concrete acts as a heat sink and provides protection to the top edge. In this case we only take the heated perimeter of the exposed steel (blue lines) as:

Hp = 0.515m

Therefore, the section factor is:

Hp/A = 297.7

For convenience, a list of common beam and columns and their Hp/A values have been tabulated on pages 9 to 31 which will allow you to easily read off the required thickness of Monokote FyreSPRAY for a given FRL. If your steel section factor is not listed please contact Trafalgar Fire for assistance in calculating your required FyreSPRAY thickness.

SYSTEM FRL APPROVALS

Number	Item	Max. FRL	Largest section factor	Limiting temperature range	Approval Report
1	Steel open web (I beams/equal angles/C-chanel/PFC etc)	240/-/-	365m-1	350-750 deg C	FAR4853
2	Steel closed sections (RHS, SHS, CHS etc)	240/-/-	365m-1	350-750 deg C	FAR4856
3	Coat-back to secondary steel members- 300mm coat-back distance	240/-/-	365m-1	350-750 deg C	FC17155-01-1
4	Interface with Trafalgar Corex Steel Protection boards with 100mm overlap	180/-/-	365m-1	350-750 deg C	FAS210135

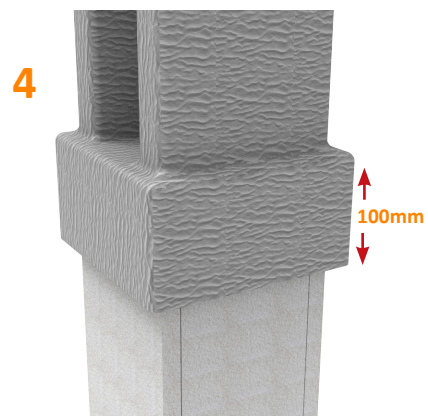
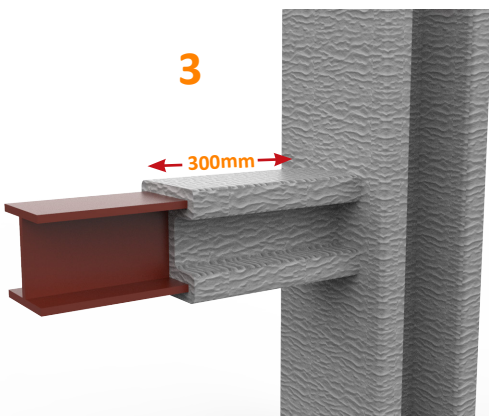
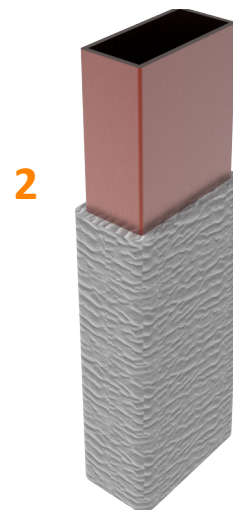
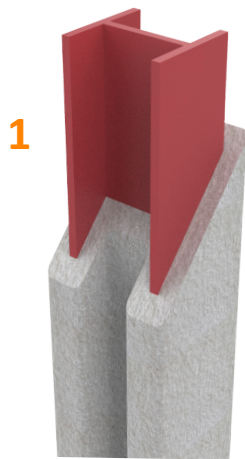

INSTALLATION



IDENTIFY STEEL TYPE AND SIZE

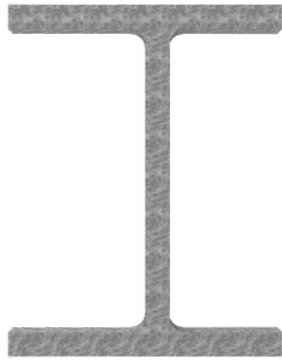

DETERMINE THE FRL



For other temperature ratings, or assistance calculating the Hp/A of the structural member, contact technical@tgroup.com.au.



DETERMINE FYRESPRAY THICKNESS

STEEL SIZE	4 SIDED ENCASEMENT				3 SIDED ENCASEMENT				2 SIDED ENCASEMENT				1 SIDED ENCASEMENT									
	Hp/A	FIRE RESISTANCE LEVELS				Hp/A	FIRE RESISTANCE LEVELS				Hp/A	FIRE RESISTANCE LEVELS				Hp/A	FIRE RESISTANCE LEVELS					
		1/m	60	90	120		180	1/m	60	90		120	180	1/m	60		90	120	180	1/m	60	90
500WC	440	35	12.5	12.5	12.5	20	30	12.5	12.5	12.5	15	20	12.5	12.5	12.5	12.5	10	12.5	12.5	12.5	12.5	
	404	40	12.5	12.5	12.5	25	30	12.5	12.5	12.5	15	20	12.5	12.5	12.5	12.5	10	12.5	12.5	12.5	12.5	
	368	40	12.5	12.5	12.5	25	30	12.5	12.5	12.5	15	20	12.5	12.5	12.5	12.5	15	12.5	12.5	12.5	12.5	
	280	55	12.5	12.5	12.5	15	15H15	35	12.5	12.5	12.5	20	25	12.5	12.5	12.5	12.5	15	12.5	12.5	12.5	12.5
	267	60	12.5	12.5	20	20H12.5	45	12.5	12.5	12.5	25	30	12.5	12.5	12.5	15	15	12.5	12.5	12.5	12.5	
400WC	328	70	12.5	12.5	20	20H15	55	12.5	12.5	15	15H15	35	12.5	12.5	12.5	20	20	12.5	12.5	12.5	12.5	
	361	40	12.5	12.5	12.5	25	30	12.5	12.5	12.5	15	20	12.5	12.5	12.5	12.5	10	12.5	12.5	12.5	12.5	
	328	40	12.5	12.5	12.5	25	30	12.5	12.5	12.5	15	20	12.5	12.5	12.5	12.5	10	12.5	12.5	12.5	12.5	
	301	45	12.5	12.5	12.5	25	35	12.5	12.5	12.5	20	25	12.5	12.5	12.5	12.5	15	12.5	12.5	12.5	12.5	
	270	50	12.5	12.5	12.5	15H15	35	12.5	12.5	12.5	20	25	12.5	12.5	12.5	12.5	15	12.5	12.5	12.5	12.5	
350WC	212	60	12.5	12.5	20	20H12.5	45	12.5	12.5	12.5	25	30	12.5	12.5	12.5	15	15	12.5	12.5	12.5	12.5	
	181	70	12.5	12.5	20	20H15	55	12.5	12.5	15	15H15	35	12.5	12.5	12.5	20	20	12.5	12.5	12.5	12.5	
	144	85	12.5	15	25	25H12.5	65	12.5	12.5	20	20H15	40	12.5	12.5	12.5	25	25	12.5	12.5	12.5	12.5	
	280	40	12.5	12.5	12.5	25	30	12.5	12.5	12.5	15	20	12.5	12.5	12.5	12.5	10	12.5	12.5	12.5	12.5	
	258	45	12.5	12.5	12.5	25	35	12.5	12.5	12.5	20	25	12.5	12.5	12.5	12.5	15	12.5	12.5	12.5	12.5	
187	50	12.5	12.5	12.5	15H15	35	12.5	12.5	12.5	20	25	12.5	12.5	12.5	12.5	15	12.5	12.5	12.5	12.5		
	55	12.5	12.5	15	15H15	40	12.5	12.5	12.5	25	30	12.5	12.5	12.5	15	15	12.5	12.5	12.5	12.5		

Find the required thickness of Monokote Fyrespray from the tables in the approvals section below.

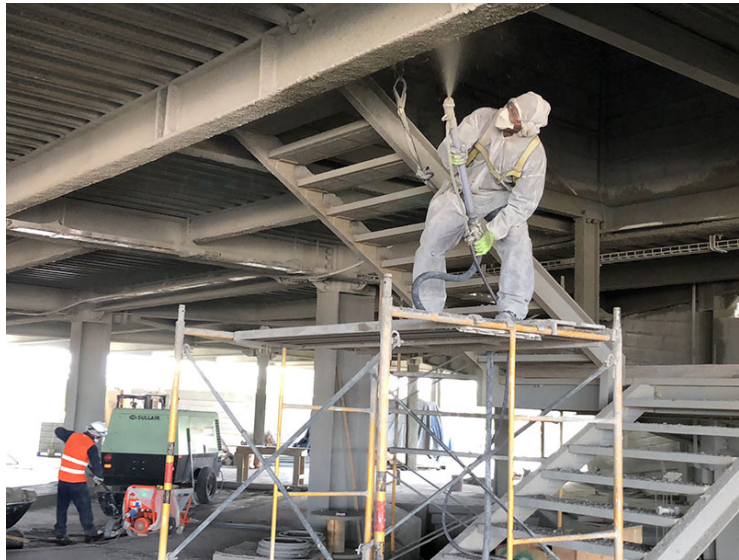

PRODUCT RANGE



Item Number	Description	Pallet QTY	Weight per bag
Monokote 13296 MK6HY	Spray Applied Fire Resistant Plaster in recyclable bag approx. 700mmx500x120mm	55x	21.9Kg
Monkote 61951 MK-Z146 Monokote 6580 Z-106HY	Spray Applied Fire Resistant Plaster suitable for weather exposed, higher durability areas,	Contact Trafalgar for more information	

PLANNING, ESTIMATING AND EQUIPMENT

YIELD AND MIXING

For comprehensive information on estimating the applied yield and water usage using both batch mixing or continuous mixers, please refer to the Monokote MK6-HY simplified Yield Chart here: [MK6 HY YIELD CHART](#). Please note that the drying times between coats will vary depending on site conditions. Typically allow 3-4 hours between applications, unless accelerative additives are injected via the mixing nozzle.

EQUIPMENT

MONOKOTE® spray systems can be used with a wide range of factory-made pumps and mixing machines including:

- **Batch mixers (recommended)**
- **Continuous mixers**
- **Accelerated mixing (with additives, contact Trafalgar for more information)**
- **Piston, hydraulic, rotor/stator and squeeze pumps**



FRL Approvals Tables

THICKNESS OF MONOKOTE MK6 H/Y FOR FRL - BEAMS

Determine the required Hp/A value of the steel as shown on page 5, then refer to the below tables to acquire the necessary thickness of Monokote FyreSPRAY. Structural Steel **Beams typically have an assumed critical temperature rating of 620 C and the following tables reflect this assumption.**

For other critical temperatures please contact Trafalgar for assistance.

Columns - Structural I/H Columns (620°)

SECTION FACTOR (HP/A)	FRL (MINUTES)					
	30 min	60 MIN	90 MIN	120 MIN	180 MIN	240 MIN
30	9	9	9	9	9	9
40	9	9	9	9	9	9
50	9	9	9	9	9	9
60	9	9	9	9	9	17
70	9	9	9	9	9	31
80	9	9	9	9	16	39
90	9	9	9	9	23	45
100	9	9	9	9	28	50
110	9	9	9	12	32	53
120	9	9	9	15	36	56
130	9	9	9	18	38	58
140	9	9	11	21	40	59
150	9	9	13	23	42	61
160	9	9	15	25	43	62
170	9	9	17	26	45	63
180	9	9	18	27	46	64
190	9	10	19	28	47	65
200	9	11	20	29	48	66
210	9	12	21	30	48	66
220	9	13	22	31	49	67
230	9	14	23	32	50	67
240	9	15	24	33	50	68
250	9	16	24	33	51	68
260	9	16	25	34	51	69
270	9	17	26	34	52	69
280	9	17	26	35	52	69
290	9	18	26	35	52	70
300	10	18	27	36	53	70
310	10	19	27	36	53	70
320	11	19	28	36	53	70
330	11	19	28	37	54	71
340	11	20	28	37	54	71
350	12	20	29	37	54	71
360	12	20	29	37	54	71
365	12	21	29	38	54	71

*For other critical temperatures, encasement types, and non-standard steel members, contract technical@tgroup.com.au.

FRL Approvals Tables

THICKNESS OF MONOKOTE MK6 H/Y FOR FRL - COLUMNS

Determine the required Hp/A value of the steel as shown on page 5, then refer to the below tables to acquire the necessary thickness of Monokote FyreSPRAY. Structural Steel **Columns typically have an assumed critical temperature rating of 550 C and the following tables reflect this assumption.**

For other critical temperatures please contact Trafalgar for assistance.

Columns - Structural I/H Columns (550°)

SECTION FACTOR (HP/A)	FRL (MINUTES)					
	30 min	60 MIN	90 MIN	120 MIN	180 MIN	240 MIN
30	9	9	9	9	9	9
40	9	9	9	9	9	9
50	9	9	9	9	9	15
60	9	9	9	9	9	33
70	9	9	9	9	18	43
80	9	9	9	9	26	49
90	9	9	9	10	32	54
100	9	9	9	14	36	57
110	9	9	9	18	39	60
120	9	9	11	21	42	62
130	9	9	14	24	44	64
140	9	9	16	26	45	65
150	9	9	18	27	47	66
160	9	10	19	29	48	67
170	9	11	20	30	49	68
180	9	12	22	31	50	69
190	9	13	23	32	51	69
200	9	14	24	33	51	70
210	9	15	24	33	52	70
220	9	16	25	34	52	71
230	9	17	26	35	53	71
240	9	17	26	35	53	71
250	9	18	27	36	54	72
260	9	18	27	36	54	72
270	10	19	28	37	55	72
280	10	19	28	37	55	73
290	11	20	29	37	55	73
300	11	20	29	38	55	73
10	12	20	29	38	56	73
320	12	21	30	38	56	74
330	12	21	30	39	56	74
340	13	21	30	39	56	74
350	13	22	30	39	57	74
360	13	22	31	39	57	74
365	13	22	31	39	57	74

*For other critical temperatures, encasement types, and non-standard steel members, contact technical@tgroup.com.au.

TRAFALGAR FYRESPRAY- MONOKOTE THICKNESS FOR COMMON STEEL TYPES AND APPLICATIONS AS4100



Note: Columns are calculated at 550°C critical temp, and Beams are calculated at 620°C critical temp.

For other critical temperatures contact technical@tgroup.com.au.

This manual can change at anytime without notice.

Please validate data with your the structural engineer for critical temperatures & fire requirements.

FRL Approvals Tables

UNIVERSAL BEAMS (620 Degrees Critical Temperature)

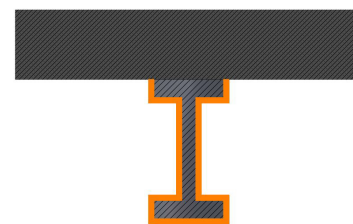

EXPOSURE CONDITIONS: I-section beam supporting lightweight or dense concrete slab.
Three (3) sided exposure. Critical temp: 620 deg. C. Ave.

MEMBER	ESA/M (M ² /T)	Hp/A (1/m)	THICKNESS OF MONOKOTE MK-6 (mm) To provide fire resistance level of					
			60 MIN	90 MIN	120 MIN	180 MIN	240 MIN	
UNIVERSAL BEAMS			60 MIN	90 MIN	120 MIN	180 MIN	240 MIN	
760 UB	244	9.5	75	9	9	9	11	35
	220	10.5	82	9	9	9	18	41
	197	11.6	91	9	9	9	24	46
	173	13.1	103	9	9	9	30	51
	148	15.2	119	9	9	15	35	55
690 UB	140	14.8	116	9	9	14	34	55
	125	16.5	130	9	9	18	38	58
610 UB	125	14.9	117	9	9	14	35	55
	113	16.4	129	9	9	18	38	57
	101	18.2	143	9	12	21	41	60
530 UB	92	17.9	141	9	11	21	40	60
	82	20	157	9	15	24	43	62
460 UB	82	17.8	140	9	11	21	40	59
	74	19.4	152	9	14	23	42	61
	67	21.5	169	9	17	26	44	63
410 UB	60	22	173	9	17	26	45	63
	54	24.3	191	10	19	29	47	65
360 UB	57	21.1	166	9	16	25	44	63
	51	23.4	184	9	19	28	46	64
	45	26.6	209	12	21	30	48	66
310 UB	46	23.5	184	10	19	28	46	65
	40	26.6	209	12	21	30	48	66
250 UB	37	24.8	195	11	20	29	47	65
	31	29.1	228	14	23	32	50	67
200 UB	30	26.5	208	12	21	30	48	66
	25	30.8	242	15	24	33	50	68
180 UB	22	27.1	213	13	22	31	49	66
	18	32.9	258	16	25	34	51	69
150 UB	18	28.3	222	14	22	31	49	67
	14	35.8	281	17	26	35	52	69

*For other critical temperatures, encasement types, and non-standard steel members, contract technical@tgroup.com.au.

FRL Approvals Tables

UNIVERSAL COLUMNS (620 Degrees Critical Temperature)

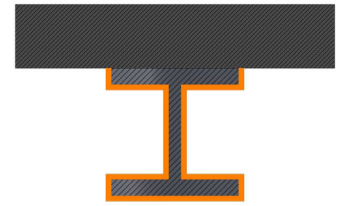

EXPOSURE CONDITIONS: I-section beam supporting lightweight or dense concrete slab.
Three (3) sided exposure. Critical temp: 620 deg. C. Ave.

MEMBER	ESA/M (M ² /T)	Hp/A (1/m)	THICKNESS OF MONOKOTE MK-6 (mm) To provide fire resistance level of					
			60 MIN	90 MIN	120 MIN	180 MIN	240 MIN	
UNIVERSAL COLUMNS			60 MIN	90 MIN	120 MIN	180 MIN	240 MIN	
310UC	283	5.7	45	9	9	9	9	9
	240	6.6	52	9	9	9	9	19
	198	7.9	62	9	9	9	9	35
	158	9.7	76	9	9	9	24	47
	137	11	86	9	9	9	30	53
	118	12.7	100	9	9	14	36	57
	97	15.3	120	9	11	21	42	62
250UC	90	13.9	109	9	9	18	39	60
	73	16.8	132	9	14	24	44	64
200UC	60	16.7	131	9	14	24	44	64
	52	18.9	148	9	17	27	46	66
	46	21.4	168	11	20	30	49	68
150UC	37	20.4	160	10	19	29	48	67
	30	24.9	195	14	23	32	51	69
	23	31.5	247	18	27	36	54	72
100UC	15	31.4	246	18	27	36	54	72

*For other critical temperatures, encasement types, and non-standard steel members, contract technical@tgroup.com.au.

FRL Approvals Tables

PARALLEL FLANGE CHANNELS (620 Degrees Critical Temperature)



EXPOSURE CONDITIONS: I-section beam supporting lightweight or dense concrete slab.
Three (3) sided exposure. Critical temp: 620 deg. C. Ave.

MEMBER	ESA/M (M ² /T)	Hp/A (1/m)	THICKNESS OF MONOKOTE MK-6 (mm) To provide fire resistance level of				
			60 MIN	90 MIN	120 MIN	180 MIN	240 MIN
PARALLEL FLANGE CHANNELS			60 MIN	90 MIN	120 MIN	180 MIN	240 MIN
380 x 100 PFC	18.7	147	9	13	22	41	60
300 x 90 PFC	21.0	165	9	16	25	44	63
250 x 90 PFC	21.0	165	9	16	25	44	63
230 x 75 PFC	26.4	207	12	21	30	48	66
200 x 75 PFC	26.3	206	12	21	30	48	66
180 x 75 PFC	26.9	211	13	22	30	48	66
150 x 75 PFC	28.5	224	14	23	31	49	67
125 PFC	37.2	292	18	27	35	52	70
100 PFC	42.1	330	20	28	37	54	71
75 PFC	46.0	361	20	29	37	54	71

*For other critical temperatures, encasement types, and non-standard steel members, contract technical@tgroup.com.au.

FRL Approvals Tables

PARALLEL FLANGE CHANNELS (620 Degrees Critical Temperature)



EXPOSURE CONDITIONS: beam supporting lightweight or dense concrete slab.

Three (3) sided exposure. Critical temp: 620 deg. C. Ave.

MEMBER	ESA/M (M ² /T)	Hp/A (1/m)	THICKNESS OF MONOKOTE MK-6 (mm) To provide fire resistance level of				
			60 MIN	90 MIN	120 MIN	180 MIN	240 MIN
PARALLEL FLANGE CHANNELS			60 MIN	90 MIN	120 MIN	180 MIN	240 MIN
380 x 100 PFC	13.9	109	9	9	11	32	53
300 x 90 PFC	16.3	128	9	9	18	38	57
250 x 90 PFC	17.0	133	9	9	19	39	58
230 x 75 PFC	21.0	165	9	16	25	44	63
200 x 75 PFC	21.8	171	9	17	26	45	63
180 x 75 PFC	23.0	180	9	18	27	46	64
150 x 75 PFC	25.2	198	11	20	29	47	66
125 PFC	32.1	252	16	25	33	51	68
100 PFC	35.9	282	17	26	35	52	69
75 PFC	39.9	313	19	27	36	53	70

*For other critical temperatures, encasement types, and non-standard steel members, contract technical@tgroup.com.au.

FRL Approvals Tables

UNEQUAL ANGLES (620 Degrees Critical Temperature)

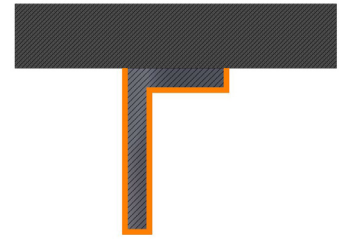

EXPOSURE CONDITIONS: I-section beam supporting lightweight or dense concrete slab.
Three (3) sided exposure. Critical temp: 620 deg. C. Ave.

MEMBER		ESA/M (M ² /T)	Hp/A (1/m)	THICKNESS OF MONOKOTE MK-6 (mm) To provide fire resistance level of				
				60 MIN	90 MIN	120 MIN	180 MIN	240 MIN
UNEQUAL ANGLES				60 MIN	90 MIN	120 MIN	180 MIN	240 MIN
150x100	12UA	17.4	137	9	15	25	45	64
	10UA	21.7	170	11	20	30	49	68
150x90	16UA	13.7	108	9	9	17	38	59
	12UA	17	133	9	14	24	44	64
	10UA	22	173	11	21	30	49	68
	8UA	26.6	209	15	24	33	52	70
125x75	12UA	17.9	141	9	16	26	45	65
	10UA	22.3	175	12	21	30	49	68
	8UA	26.9	211	15	24	34	52	70
100x75	6UA	34.6	272	19	28	37	55	72
	10UA	21.5	169	11	20	30	49	68
	8UA	25.9	203	15	24	33	51	70
75x50	6UA	33.5	263	19	27	36	54	72
	8UA	27.9	219	16	25	34	52	71
	6UA	34.1	268	19	28	37	54	72
65x50	5UA	46.0	361	22	31	39	57	74
	8UA	26.6	209	15	24	33	52	70
	6UA	33.9	266	19	28	37	54	72
	5UA	45.2	354	22	31	39	57	74

*For other critical temperatures, encasement types, and non-standard steel members, contract technical@tgroup.com.au.

FRL Approvals Tables

EQUAL ANGLES

(620 Degrees Critical Temperature)

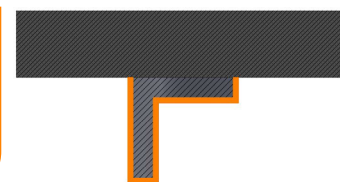

EXPOSURE CONDITIONS: I-section beam supporting lightweight or dense concrete slab.
Three (3) sided exposure. Critical temp: 620 deg. C. Ave.

MEMBER	ESA/M (M ² /T)	Hp/A (1/m)	THICKNESS OF MONOKOTE MK-6 (mm) To provide fire resistance level of					
			60 MIN	90 MIN	120 MIN	180 MIN	240 MIN	
EQUAL ANGLES			60 MIN	90 MIN	120 MIN	180 MIN	240 MIN	
200x200	26EA	7.7	60	9	9	9	9	34
	20Ea	9.8	77	9	9	9	24	48
	18EA	10.8	85	9	9	9	29	52
	16EA	12.1	95	9	9	12	34	56
	13EA	14.7	115	9	10	20	40	61
150x150	19EA	10.5	82	9	9	9	28	51
	16EA	12.4	97	9	9	13	35	57
	12EA	16.1	126	9	13	23	43	63
	10EA	20.1	158	9	19	28	48	67
125x125	16EA	12.6	99	9	9	14	35	57
	12EA	16.3	128	9	13	23	43	63
	10EA	20.3	159	9	19	29	48	67
	8EA	24.6	193	14	23	32	51	69
100x100	12EA	16.5	130	9	13	23	43	63
	10EA	20.6	162	10	19	29	48	67
	8EA	24.7	194	14	23	32	51	69
	6EA	31.9	250	18	27	36	54	72
90x90	10EA	20.6	162	10	19	29	48	67
	8EA	24.7	194	14	23	32	51	69
	6EA	31.9	250	18	27	36	54	72
75x75	10EA	20.7	162	10	19	29	48	67
	8EA	24.9	195	14	23	32	51	69
	6EA	31.9	250	18	27	36	54	72
	5EA	42.8	336	21	30	39	56	74
65x65	10EA	21.1	166	10	20	29	48	67
	8EA	25.3	199	14	23	33	51	70
	6EA	32.4	254	18	27	36	54	72
	5EA	43.1	338	21	30	39	56	74

*For other critical temperatures, encasement types, and non-standard steel members, contract technical@tgroup.com.au.

FRL Approvals Tables

WELDED BEAMS (620 Degrees Critical Temperature)

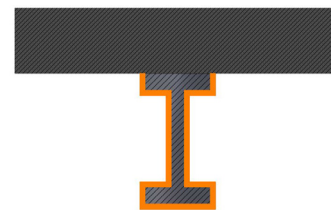

EXPOSURE CONDITIONS: I-section beam supporting lightweight or dense concrete slab.
Three (3) sided exposure. Critical temp: 620 deg. C. Ave.

MEMBER	ESA/M (M ² /T)	Hp/A (1/m)	THICKNESS OF MONOKOTE MK-6 (mm) To provide fire resistance level of					
			60 MIN	90 MIN	120 MIN	180 MIN	240 MIN	
WELDED BEAMS			60 MIN	90 MIN	120 MIN	180 MIN	240 MIN	
1200WB	455	8.5	67	9	9	9	9	27
	423	9.1	71	9	9	9	9	32
	392	9.8	77	9	9	9	13	37
	342	10.4	82	9	9	9	17	41
	317	11.1	87	9	9	9	21	44
	278	12.1	95	9	9	9	26	48
	249	12.6	99	9	9	9	28	49
1000WB	322	10	79	9	9	9	15	38
	296	10.8	85	9	9	9	20	42
	258	11.8	93	9	9	9	25	47
	215	13.4	105	9	9	10	31	52
900WB	282	10.7	84	9	9	9	19	42
	257	11.7	92	9	9	9	24	46
	218	13	102	9	9	9	29	50
	175	15.3	120	9	9	15	36	56
800WB	192	13.1	103	9	9	9	30	51
	168	14.5	114	9	9	13	34	54
	146	16.5	130	9	9	18	38	58
	122	18.9	148	9	13	22	42	61
700WB	173	13	102	9	9	9	29	50
	150	14.3	112	9	9	13	33	54
	130	16.3	128	9	9	18	38	57
	115	18.4	144	9	12	22	41	60

*For other critical temperatures, encasement types, and non-standard steel members, contract technical@tgroup.com.au.

FRL Approvals Tables

WELDED COLUMNS (620 Degrees Critical Temperature)

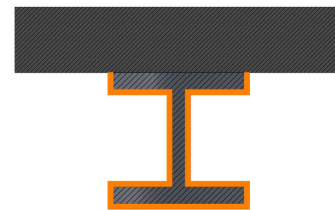

EXPOSURE CONDITIONS: I-section beam supporting lightweight or dense concrete slab.
Three (3) sided exposure. Critical temp: 620 deg. C. Ave.

MEMBER	ESA/M (M ² /T)	Hp/A (1/m)	THICKNESS OF MONOKOTE MK-6 (mm) To provide fire resistance level of					
			60 MIN	90 MIN	120 MIN	180 MIN	240 MIN	
WELDED COLUMNS			60 MIN	90 MIN	120 MIN	180 MIN	240 MIN	
500WC	440	5.4	42	9	9	9	9	9
	414	5.8	46	9	9	9	9	9
	383	6.2	49	9	9	9	9	12
	340	7.3	57	9	9	9	9	29
	290	8.5	67	9	9	9	15	40
	267	9.2	72	9	9	9	20	45
	228	10.7	84	9	9	9	29	51
400WC	361	5.5	43	9	9	9	9	9
	328	6.1	48	9	9	9	9	9
	303	6.6	52	9	9	9	9	19
	270	7.3	57	9	9	9	9	29
	212	9.2	72	9	9	9	20	45
	181	10.7	84	9	9	9	29	51
	144	13.4	105	9	9	17	38	59
350WC	280	6.1	48	9	9	9	9	9
	258	6.5	51	9	9	9	9	18
	230	7.3	57	9	9	9	9	29
	197	8.5	67	9	9	9	15	40

*For other critical temperatures, encasement types, and non-standard steel members, contract technical@tgroup.com.au.

FRL Approvals Tables

SQUARE HOLLOW SECTIONS (620 Degrees Critical Temperature)

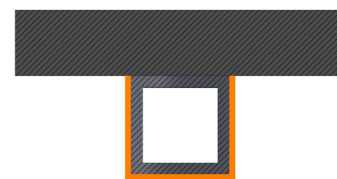

EXPOSURE CONDITIONS: beam supporting lightweight or dense concrete slab. **Three (3) sided exposure. Critical temp: 620 deg. C. Ave.**

MEMBER	ESA/M (M ² /T)	Hp/A (1/m)	THICKNESS OF MONOKOTE MK-6 (mm) To provide fire resistance level of					
			60 MIN	90 MIN	120 MIN	180 MIN	240 MIN	
SQUARE HOLLOW SECTIONS			60 MIN	90 MIN	120 MIN	180 MIN	240 MIN	
250 x 250 SHS	9	11.0	86	9	9	9	30	52
	6	16.3	128	9	13	23	43	63
200 x 200 SHS	9	11.0	87	9	9	9	30	53
	6	16.4	128	9	13	23	43	63
	5	19.5	153	9	18	28	47	66
150 x 150 SHS	9	11.2	88	9	9	9	31	53
	6	16.5	130	9	13	23	43	63
	5	19.7	154	9	18	28	47	66
125 x 125 SHS	9	11.3	89	9	9	9	31	54
	6	16.6	130	9	14	24	44	64
	5	19.7	155	9	18	28	47	66
	4	24.7	194	14	23	32	51	69
100 x 100 SHS	9	11.6	91	9	9	10	32	54
	6	16.8	132	9	14	24	44	64
	5	20.0	157	9	19	28	47	67
	4	24.9	195	14	23	32	51	69
	3	32.8	258	18	27	36	54	72
89 x 89 SHS	6	16.9	132	9	14	24	44	64
	5	20.0	157	9	19	28	47	67
	3.5	28.4	223	16	25	34	53	71
75 x 75 SHS	6	17.1	134	9	15	24	44	64
	5	20.3	159	9	19	29	48	67
	4	25.2	198	14	23	33	51	70
	3.5	28.6	225	16	25	34	53	71
	3	33.2	260	18	27	36	54	72
65 x 65 SHS	6	17.3	136	9	15	25	45	64
	5	20.5	161	10	19	29	48	67
	4	25.5	200	14	23	33	51	70
	3	33.4	262	18	27	36	54	72
50 x 50 SHS	5	21.2	167	10	20	30	49	68
	4	26.0	204	15	24	33	51	70
	3	33.9	266	19	28	37	54	72

*For other critical temperatures, encasement types, and non-standard steel members, contract technical@tgroup.com.au.

FRL Approvals Tables

RECTANGULAR HOLLOW SECTIONS (620 Degrees Critical Temperature)

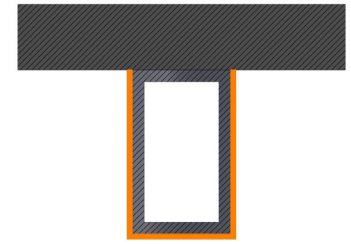

EXPOSURE CONDITIONS: beam supporting lightweight or dense concrete slab. **Three (3) sided exposure. Critical temp: 620 deg. C. Ave.**

MEMBER	ESA/M (M ² /T)	Hp/A (1/m)	THICKNESS OF MONOKOTE MK-6 (mm) To provide fire resistance level of					
			60 MIN	90 MIN	120 MIN	180 MIN	240 MIN	
RECTANGULAR HOLLOW SECTIONS			60 MIN	90 MIN	120 MIN	180 MIN	240 MIN	
250 x 150 RHS	9	12.1	95	9	9	12	34	56
	6	17.9	140	9	16	26	45	65
	5	21.3	167	11	20	30	49	68
200 x 100 RHS	9	12.5	98	9	9	14	35	57
	6	18.5	145	9	17	26	46	65
	5	22.0	173	11	21	30	49	68
	4	27.5	216	16	25	34	52	71
150 x 100 RHS	6	17.7	139	9	15	25	45	65
	5	21.0	165	10	20	29	48	67
	4	26.3	207	15	24	33	52	70
150 x 50 RHS	5	23.4	184	13	22	31	50	69
	4	29.2	229	17	26	35	53	71
	3	38.5	302	20	29	38	56	73
125 x 75 RHS	5	21.8	171	11	21	30	49	68
	4	27.2	214	15	25	34	52	70
	3	35.9	282	19	28	37	55	73
100 x 50 RHS	6	19.2	150	9	18	27	47	66
	5	22.7	178	12	21	31	50	68
	4	28.3	222	16	25	34	53	71
	3.5	32.1	252	18	27	36	54	72
	3	37.2	292	20	29	38	55	73
75 x 50 RHS	6	18.6	146	9	17	27	46	66
	5	21.9	172	11	21	30	49	68
	4	27.2	214	15	25	34	52	70
	3	35.7	280	19	28	37	55	73

*For other critical temperatures, encasement types, and non-standard steel members, contract technical@tgroup.com.au.

FRL Approvals Tables

UNIVERSAL BEAMS (550 Degrees Critical Temperature)

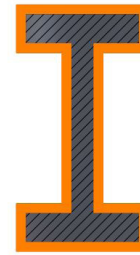

EXPOSURE CONDITIONS: Fully exposed steel beam or column sections. **Four (4) sided exposure. Critical temp: 550 deg. C. Ave.**

MEMBER	ESA/M (M ² /T)	Hp/A (1/m)	THICKNESS OF MONOKOTE MK-6 (mm) To provide fire resistance level of					
			60 MIN	90 MIN	120 MIN	180 MIN	240 MIN	
UNIVERSAL BEAMS			60 MIN	90 MIN	120 MIN	180 MIN	240 MIN	
760UB	244	10.6	83	9	9	9	28	51
	220	11.7	92	9	9	11	33	55
	197	12.9	101	9	9	15	36	58
	173	14.6	115	9	9	20	40	61
	148	17.1	134	9	15	24	44	64
690UB	140	16.6	130	9	14	24	44	64
	125	18.6	146	9	17	27	46	66
610UB	125	16.7	131	9	14	24	44	64
	113	18.4	144	9	17	26	46	65
	101	20.5	161	10	19	29	48	67
530UB	92	20.1	158	9	19	28	48	67
	82	22.6	177	12	21	31	50	68
460UB	82	20.1	158	9	19	28	48	67
	74	22.0	173	11	21	30	49	68
	67	24.3	191	13	23	32	51	69
410UB	60	25.0	196	14	23	32	51	70
	54	27.6	217	16	25	34	52	71
360UB	57	24.2	190	13	23	32	51	69
	51	26.8	210	15	24	34	52	70
	45	30.4	239	17	26	35	53	71
310UB	46	27.1	213	15	25	34	52	70
	40	30.7	241	17	26	35	53	72
250UB	37	28.7	225	16	25	34	53	71
	31	33.8	265	19	28	37	54	72
200UB	30	31.0	243	17	26	35	54	72
	25	36.0	283	19	28	37	55	73
180UB	22	31.1	244	17	27	36	54	72
	18	37.8	297	20	29	38	55	73
150UB	18	32.4	254	18	27	36	54	72
	14	41.1	323	21	30	38	56	74

*For other critical temperatures, encasement types, and non-standard steel members, contract technical@tgroup.com.au.

FRL Approvals Tables

UNIVERSAL COLUMNS (550 Degrees Critical Temperature)

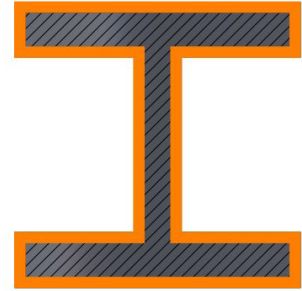

EXPOSURE CONDITIONS: Fully exposed steel beam or column sections. **Four (4) sided exposure. Critical temp: 550 deg. C. Ave.**

MEMBER	ESA/M (M ² /T)	Hp/A (1/m)	THICKNESS OF MONOKOTE MK-6 (mm) To provide fire resistance level of					
			60 MIN	90 MIN	120 MIN	180 MIN	240 MIN	
UNIVERSAL COLUMNS			60 MIN	90 MIN	120 MIN	180 MIN	240 MIN	
310UC	283	6.9	54	9	9	9	9	24
	240	7.9	62	9	9	9	9	35
	198	9.4	74	9	9	9	22	46
	158	11.6	91	9	9	10	32	54
	137	13.3	104	9	9	16	37	59
	118	15.3	120	9	11	21	42	62
250UC	97	18.5	145	9	17	26	46	65
	90	16.8	132	9	14	24	44	64
200UC	73	20.3	159	9	19	29	48	67
	60	20.2	159	9	19	28	48	67
	52	22.8	179	12	21	31	50	68
150UC	46	25.8	203	14	24	33	51	70
	37	24.5	192	14	23	32	51	69
	30	30	236	17	26	35	53	71
100UC	23	38	298	20	29	38	55	73
	15	38	298	20	29	38	55	73

*For other critical temperatures, encasement types, and non-standard steel members, contract technical@tgroup.com.au.

FRL Approvals Tables

PARALLEL FLANGE CHANNELS (550 Degrees Critical Temperature)

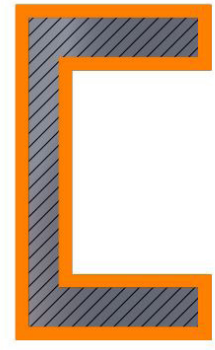

EXPOSURE CONDITIONS: Fully exposed steel beam or column sections. **Four (4) sided exposure. Critical temp: 550 deg. C. Ave.**

MEMBER	ESA/M (M ² /T)	Hp/A (1/m)	THICKNESS OF MONOKOTE MK-6 (mm) To provide fire resistance level of				
			60 MIN	90 MIN	120 MIN	180 MIN	240 MIN
PARALLEL FLANGE CHANNELS			60 MIN	90 MIN	120 MIN	180 MIN	240 MIN
380 x 100 PFC	20.5	161	10	19	29	48	67
300 x 90 PFC	23.2	182	12	22	31	50	69
250 x 90 PFC	23.5	184	13	22	31	50	69
230 x 75 PFC	29.4	231	17	26	35	53	71
200 x 75 PFC	29.6	232	17	26	35	53	71
180 x 75 PFC	30.5	239	17	26	35	53	71
150 x 75 PFC	32.7	257	18	27	36	54	72
125 PFC	42.7	336	21	30	39	56	74
100 PFC	48.3	379	22	31	40	57	75
75 PFC	53.0	416	23	32	40	58	75

*For other critical temperatures, encasement types, and non-standard steel members, contract technical@tgroup.com.au.

FRL Approvals Tables

UNEQUAL ANGLES (550 Degrees Critical Temperature)

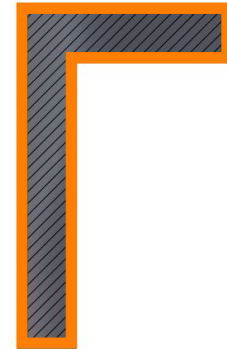

EXPOSURE CONDITIONS: Fully exposed steel beam or column sections. **Four (4) sided exposure. Critical temp: 550 deg. C. Ave.**

MEMBER	ESA/M (M ² /T)	Hp/A (1/m)	THICKNESS OF MONOKOTE MK-6 (mm) To provide fire resistance level of					
			60 MIN	90 MIN	120 MIN	180 MIN	240 MIN	
UNEQUAL ANGLES			60 MIN	90 MIN	120 MIN	180 MIN	240 MIN	
150x100	12UA	21.8	171	9	9	20	40	61
	10UA	27.3	214	11	20	30	49	68
150x90	16UA	16.9	133	9	10	20	40	61
	12UA	21.8	171	11	21	30	49	68
	10UA	27.2	214	15	24	33	52	70
	8UA	32.9	258	9	10	20	41	61
125x75	12UA	22.1	173	11	21	30	49	68
	10UA	27.6	217	15	24	33	52	70
	8UA	33.2	261	9	11	21	41	62
	6UA	43.8	344	11	21	30	49	68
100x75	10UA	27.6	217	15	24	33	52	70
	8UA	33.2	261	18	27	36	54	72
	6UA	44.0	345	9	11	21	42	62
75x50	8UA	34.8	273	12	21	31	49	68
	6UA	44.6	350	15	24	33	52	70
	5UA	57.5	451	18	27	36	54	72
65x50	8UA	34.1	268	21	30	39	56	74
	6UA	44.8	352	12	21	31	49	68
	5UA	57.7	453	15	24	33	52	70

*For other critical temperatures, encasement types, and non-standard steel members, contract technical@tgroup.com.au.

FRL Approvals Tables

EQUAL ANGLES

(550 Degrees Critical Temperature)



EXPOSURE CONDITIONS: Fully exposed steel beam or column sections. **Four (4) sided exposure. Critical temp: 550 deg. C. Ave.**

MEMBER	ESA/M (M ² /T)	Hp/A (1/m)	THICKNESS OF MONOKOTE MK-6 (mm)					
			60 MIN	90 MIN	120 MIN	180 MIN	240 MIN	
EQUAL ANGLES			60 MIN	90 MIN	120 MIN	180 MIN	240 MIN	
200x200	26EA	10.3	81	9	9	9	27	50
	20Ea	13.1	103	9	9	16	37	58
	18EA	14.5	114	9	9	19	40	61
	16EA	16.2	127	9	13	23	43	63
	13EA	19.7	155	9	18	28	47	66
150x150	19EA	14.0	110	9	9	18	39	60
	16EA	16.7	131	9	14	24	44	64
	12EA	21.6	170	11	20	30	49	68
	10EA	26.9	211	15	24	34	52	70
125x125	16EA	16.9	133	9	14	24	44	64
	12EA	21.8	171	11	21	30	49	68
	10EA	27.3	214	15	25	34	52	70
	8EA	33.0	259	18	27	36	54	72
100x100	12EA	22.1	173	11	21	30	49	68
	10EA	27.6	217	16	25	34	52	71
	8EA	33.2	261	18	27	36	54	72
	6EA	43.8	344	21	30	39	56	74
90x90	10EA	27.7	217	16	25	34	52	71
	8EA	33.2	261	18	27	36	54	72
	6EA	43.9	345	22	30	39	57	74
75x75	10EA	27.8	218	16	25	34	52	71
	8EA	33.4	262	18	27	36	54	72
	6EA	44.2	347	22	30	39	57	74
	5EA	57.1	449	24	32	41	58	75
65x65	10EA	28.3	222	16	25	34	53	71
	8EA	34.0	267	19	28	37	54	72
	6EA	44.5	349	22	30	39	57	74
	5EA	57.4	451	24	32	41	58	75

*For other critical temperatures, encasement types, and non-standard steel members, contract technical@tgroup.com.au.

FRL Approvals Tables

WELDED BEAMS (550 Degrees Critical Temperature)

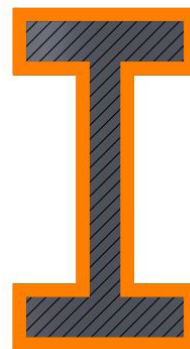

EXPOSURE CONDITIONS: Fully exposed steel beam or column sections. **Four (4) sided exposure. Critical temp: 550 deg. C. Ave.**

MEMBER	ESA/M (M ² /T)	Hp/A (1/m)	THICKNESS OF MONOKOTE MK-6 (mm) To provide fire resistance level of					
			60 MIN	90 MIN	120 MIN	180 MIN	240 MIN	
WELDED BEAMS			60 MIN	90 MIN	120 MIN	180 MIN	240 MIN	
1200WB	455	9.6	75	9	9	9	23	47
	423	10.3	81	9	9	9	27	50
	392	11.1	87	9	9	9	30	53
	342	11.5	90	9	9	10	32	54
	317	12.4	97	9	9	13	35	57
	278	13.3	104	9	9	16	37	59
	249	13.7	108	9	9	17	38	59
1000WB	322	11.2	88	9	9	9	31	53
	296	12.1	95	9	9	12	34	56
	258	13.1	103	9	9	16	37	58
	215	14.8	116	9	10	20	41	61
900WB	282	12.1	95	9	9	12	34	56
	257	13.3	104	9	9	16	37	59
	218	14.6	115	9	9	20	40	61
	175	17.0	133	9	14	24	44	64
800WB	192	14.7	115	9	10	20	40	61
	168	16.1	126	9	13	23	43	63
	146	18.4	144	9	17	26	46	65
	122	20.9	164	10	20	29	48	67
700WB	173	14.5	114	9	9	19	40	61
	150	16.0	126	9	13	23	43	63
	130	18.3	144	9	16	26	46	65
	115	20.6	162	10	19	29	48	67

*For other critical temperatures, encasement types, and non-standard steel members, contract technical@tgroup.com.au.

FRL Approvals Tables

WELDED COLUMNS (550 Degrees Critical Temperature)



EXPOSURE CONDITIONS: Fully exposed steel beam or column sections. **Four (4) sided exposure. Critical temp: 550 deg. C. Ave.**

MEMBER	ESA/M (M ² /T)	Hp/A (1/m)	THICKNESS OF MONOKOTE MK-6 (mm) To provide fire resistance level of					
			60 MIN	90 MIN	120 MIN	180 MIN	240 MIN	
WELDED COLUMNS			60 MIN	90 MIN	120 MIN	180 MIN	240 MIN	
500WC	440	6.5	51	9	9	9	9	18
	414	7.0	55	9	9	9	9	25
	383	7.5	59	9	9	9	9	31
	340	8.8	69	9	9	9	17	42
	290	10.2	80	9	9	9	26	50
	267	11.1	87	9	9	9	30	53
	228	12.9	101	9	9	15	36	58
400WC	361	6.6	52	9	9	9	9	19
	328	7.3	57	9	9	9	9	29
	303	7.9	62	9	9	9	9	35
	270	8.8	69	9	9	9	17	42
	212	11.1	87	9	9	9	30	53
	181	13.0	102	9	9	15	37	58
	144	16.1	126	9	13	23	43	63
350WC	280	7.3	57	9	9	9	9	29
	258	7.9	62	9	9	9	9	35
	230	8.8	69	9	9	9	17	42
	197	10.3	81	9	9	9	27	50

*For other critical temperatures, encasement types, and non-standard steel members, contract technical@tgroup.com.au.

FRL Approvals Tables

SQUARE HOLLOW SECTIONS (550 Degrees Critical Temperature)

EXPOSURE CONDITIONS: Fully exposed steel beam or column sections. **Four (4) sided exposure. Critical temp: 550 deg. C. Ave.**

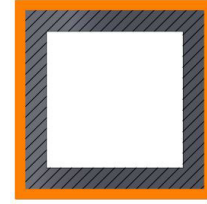

MEMBER	ESA/M (M ² /T)	Hp/A (1/m)	THICKNESS OF MONOKOTE MK-6 (mm) To provide fire resistance level of					
			60 MIN	90 MIN	120 MIN	180 MIN	240 MIN	
SQUARE HOLLOW SECTIONS			60 MIN	90 MIN	120 MIN	180 MIN	240 MIN	
250 x 250 SHS	9	14.6	115	9	9	20	40	61
	6	21.7	170	11	20	30	49	68
200 x 200 SHS	9	14.7	115	9	10	20	40	61
	6	21.8	171	11	21	30	49	68
	5	26.0	204	15	24	33	52	70
150 x 150 SHS	9	14.9	117	9	10	20	41	61
	6	22.0	173	11	21	30	49	68
	5	26.2	206	15	24	33	52	70
125 x 125 SHS	9	15.1	119	9	11	21	41	62
	6	22.1	173	11	21	30	49	68
	5	26.3	206	15	24	33	52	70
	4	32.9	258	18	27	36	54	72
100 x 100 SHS	9	15.4	121	9	11	21	42	62
	6	22.4	176	12	21	31	49	68
	5	26.6	209	15	24	33	52	70
	4	33.2	260	18	27	36	54	72
	3	43.8	344	21	30	39	56	74
89 x 89 SHS	6	22.5	177	12	21	31	49	68
	5	26.7	210	15	24	33	52	70
	3.5	37.9	297	20	29	38	55	73
75 x 75 SHS	6	22.8	179	12	21	31	50	68
	5	27.0	212	15	24	34	52	70
	4	33.6	264	19	28	36	54	72
	3.5	38.2	300	20	29	38	55	73
	3	44.2	347	22	30	39	57	74
65 x 65 SHS	6	23.1	181	12	22	31	50	69
	5	27.3	214	15	25	34	52	70
	4	33.9	266	19	28	37	54	72
	3	44.5	349	22	30	39	57	74
50 x 50 SHS	5	28.3	222	16	25	34	53	71
	4	34.6	272	19	28	37	55	72
	3	45.2	355	22	31	39	57	74

*For other critical temperatures, encasement types, and non-standard steel members, contract technical@tgroup.com.au.

FRL Approvals Tables

RECTANGULAR HOLLOW SECTIONS (550 Degrees Critical Temperature)

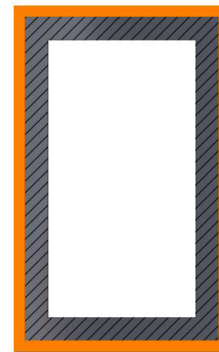

EXPOSURE CONDITIONS: Fully exposed steel beam or column sections. **Four (4) sided exposure. Critical temp: 550 deg. C. Ave.**

MEMBER	ESA/M (M ² /T)	Hp/A (1/m)	THICKNESS OF MONOKOTE MK-6 (mm) To provide fire resistance level of				
			60 MIN	90 MIN	120 MIN	180 MIN	240 MIN
RECTANGULAR HOLLOW SECTIONS			60 MIN	90 MIN	120 MIN	180 MIN	240 MIN
250 x 150 RHS	9	14.7	9	10	20	40	61
	6	21.8	11	21	30	49	68
	5	26.0	15	24	33	52	70
200 x 100 RHS	9	14.9	9	10	20	41	61
	6	22.0	11	21	30	49	68
	5	26.2	15	24	33	52	70
	4	32.7	18	27	36	54	72
150 x 100 RHS	6	22.1	11	21	30	49	68
	5	26.3	15	24	33	52	70
	4	32.9	18	27	36	54	72
150 x 50 RHS	5	26.6	15	24	33	52	70
	4	33.2	18	27	36	54	72
	3	43.8	21	30	39	56	74
125 x 75 RHS	5	26.6	15	24	33	52	70
	4	33.2	18	27	36	54	72
	3	43.8	21	30	39	56	74
100 x 50 RHS	6	22.8	12	21	31	50	68
	5	27.0	15	24	34	52	70
	4	33.6	19	28	36	54	72
	3.5	38.2	20	29	38	55	73
	3	44.2	22	30	39	57	74
75 x 50 RHS	6	23.2	12	22	31	50	69
	5	27.4	16	25	34	52	70
	4	34.0	19	28	37	54	72
	3	44.6	22	30	39	57	74

*For other critical temperatures, encasement types, and non-standard steel members, contract technical@tgroup.com.au.

FRL Approvals Tables

CIRCULAR HOLLOW SECTIONS (550 Degrees Critical Temperature)



EXPOSURE CONDITIONS: Fully exposed steel beam or column sections. **Four (4) sided exposure. Critical temp: 550 deg. C. Ave.**

MEMBER	ESA/M (M ² /T)	Hp/A (1/m)	THICKNESS OF MONOKOTE MK-6 (mm) To provide fire resistance level of				
			60 MIN	90 MIN	120 MIN	180 MIN	240 MIN
CIRCULAR HOLLOW SECTIONS			60 MIN	90 MIN	120 MIN	180 MIN	240 MIN
323.9 OD	20.3	159	9	19	29	48	67
273.1 OD	20.4	160	10	19	29	48	67
219.1 OD	20.5	161	10	19	29	48	67
168.3 OD	20.7	162	10	19	29	48	67
139.7 OD	26.4	207	15	24	33	52	70
114.3 OD	29.5	231	17	26	35	53	71
101.6 OD	33.2	260	18	27	36	54	72
88.9 OD	33.3	262	18	27	36	54	72
76.1 OD	37.1	292	20	29	38	55	73
60.3 OD	37.6	295	20	29	38	55	73

*For other critical temperatures, encasement types, and non-standard steel members, contact technical@tgroup.com.au.

SHS - SPRAY OVER COREX BOARD INTERFACE

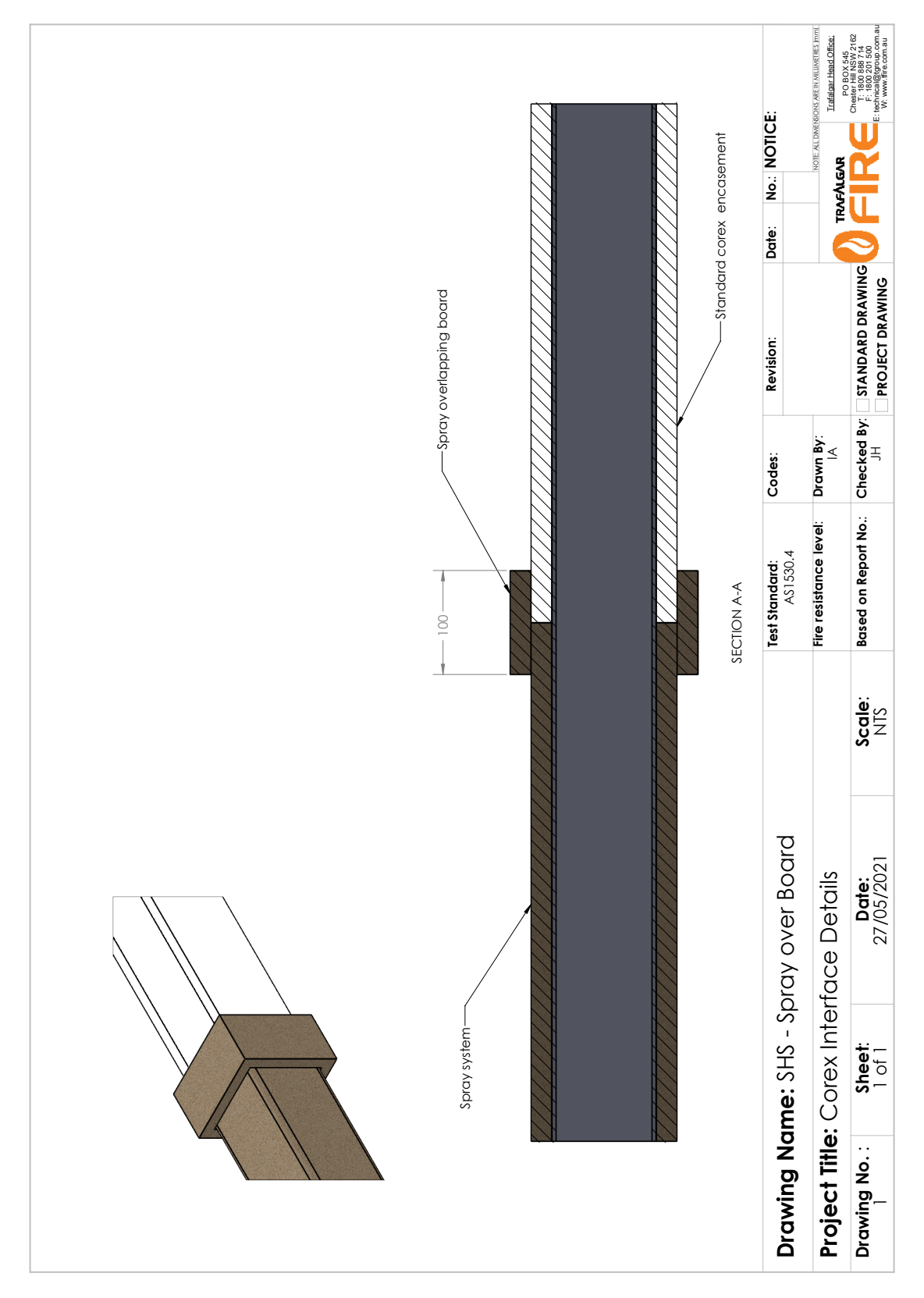

SHS - COREX BOARD OVER FYRESPRAY INTERFACE

