

TRAFALGAR COREX SOLID FIRE WALLS

Trafalgar Corex is a lightweight, impact resistant, high performance fire rated board. Such properties make it ideal for the construction of solid partitions for use as fire rated partitions, solid fire walls, shaft walls and vertical bulkheads to enclose services.



KEY FEATURES



- Lightweight boards
- Thin partition footprint
- Install from one side
- Impact resistant
- FRL up to 2 hours
- Compliance with AS1530.4-2014 and AS4072.1
- Easy to cut and handle
- Low thermal conductivity
- Non-combustible
- Environmentally friendly/sustainable

APPLICATIONS



- Solid partition walls for 60, 90 and 120 minute FRL's for:
 - Riser Shaft walls
 - Partitions
 - Solid Fire Walls
- Steel protection
- Vertical bulkheads up 4m high

TRADES



TABLE OF CONTENTS



Contents		Page
	Overview	1
	What is a Solid Fire Wall and Trafalgar Corex?	3
	Product Specifications	4
	FRL Details	5
FRL Tables	Trafalgar Corex Solid Fire Wall	6
	Trafalgar Corex Solid Fire Wall 90min	7
	Trafalgar Corex Solid Fire Wall 120min	8
	FyreBOX	9
	Access Panels	10
Installation	Trafalgar CoreSolid Fire Wall	11
	Product Range	13
	FAQs	14
	Technical Drawings	15

TRAFALGAR COREX

WHAT IS A SOLID FIRE WALL AND TRAFALGAR COREX ?

A solid fire wall is a specially designed wall system that is constructed to prevent the spread of fire from one area to another within a building. It is built using materials and construction techniques that offer a specified level of fire resistance.

Trafalgar Corex is a lightweight, high performance fire rated board. It has a glass-reinforced gypsum-based material, which is environmentally friendly and meets all requirements for asbestos and volatile organic compounds (VOC's) with sustainability certification.

Trafalgar Corex boards are able to withstand high temperatures while remaining stable and crack free, providing an ideal product for fire protection. Particularly suited to constructing vertical fire rated bulkheads, Trafalgar Corex is approved to the current AS1530.4 – 2014 and AS4072.1 as a fire rated solid partition wall.

Whilst this manual will focus on shaft walls constructed with Trafalgar Corex, it can also be used in steel protection systems and vertical bulkheads in accordance with AS4100.

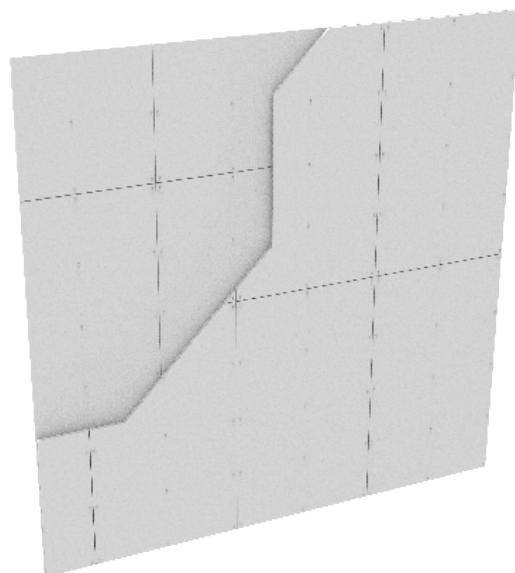

APPLICATIONS: EXPANDED

Trafalgar Corex boards are suitable for constructing shaft walls using 64mm studs and fixings to secure to fire rated walls such as concrete, masonry or plasterboard.

PRODUCT SPECIFICATIONS

PROPERTY	12.5mm THICK	15mm THICK	20mm THICK	25mm THICK
Length	2000mm			
Width	1200mm			
Average Weight	11.5kg/m ²	13.5kg/m ²	17.6kg/m ²	21.9kg/m ²
Weight per sheet	27.6kg	32.4kg	42.24kg	52.6kg
Flexural Strength (vertical)	≥725N	≥870N	≥1160N	≥1450N
Flexural Strength (horizontal)	≥300N	≥360N	≥450N	≥600N
Thermal Conductivity	0.25W/mK			
TRAFALGAR COREX CONSTRUCTION SPEC	Boards	2x15mm	2x20mm	2x25mm
	FRL	-/60/60	-/90/90	-/120/120
	Flexural strength (Perpendicular)	≥ 870 N	≥ 1160 N	≥ 1450 N
	Flexural strength (Parallel)	≥ 360 N	≥ 480 N	≥ 600 N
	Acoustics	Up to Rw 56 (2-layer Trafalgar Corex systems with 50mm mineral wool)		
	Studs	64mm x 0.6BMT		
	Stud centres	400mm		
	Stud fixings	6g x 45mm screws at 500mm centres		
	First layer fixings	8 gx 45mm at 400mm centres		
	Second layer fixings	8g x 75mm at 300mm centres		
	Joint sealant	Trafalgar FyreFLEX acrylic sealant		
	Joint tape	Fibreglass joint tape		

FRL DETAILS

FIRE RATING – HOW IS FIRE PERFORMANCE MEASURED?

An FRL (fire resistance level) is a handy way of summarising the performance of a building element. It consists of 3 numbers, all given in minutes:

FRL 120/120/120

(example)



Structural Adequacy

The ability of the building element to support the weight of adjacent building elements.

ie: a brick wall supporting a concrete floor slab above.



Integrity

The ability of an element to prevent the passage of flames and hot gasses.

ie: a plasterboard wall remaining intact and not allowing holes to form.



Insulation

The ability of an element to resist heat transfer from the exposed face to the unexposed face.

ie: a bundle of cables remaining below a set temperature limit on the unexposed side of the wall penetration system.

Note: Penetrations are not required to have a Structural Adequacy rating and is usually expressed as a dash. For example, a penetration through a 2 hour load bearing wall would be written as -/120/120.

STRUCTURAL ADEQUACY

These walls are non-load bearing and therefore does not have a structural adequacy rating.

INTEGRITY

The Trafalgar Corex board can achieve the integrity performance for up to 2 hours when used as a vertical shaft wall or bulkhead and can stop the direct spread of fire in (or out) of the enclosure.

INSULATION (TEMPERATURE RISE)

Heat transfer (or heat rise) through a Trafalgar Corex shaft wall will occur at different times depending on the thickness of the board used. Refer to the FRL tables below for more information on the FRL's that can be achieved depending on the thickness of the shaft wall.

FRL TABLES

TRAFALGAR COREX SOLID FIRE WALLS

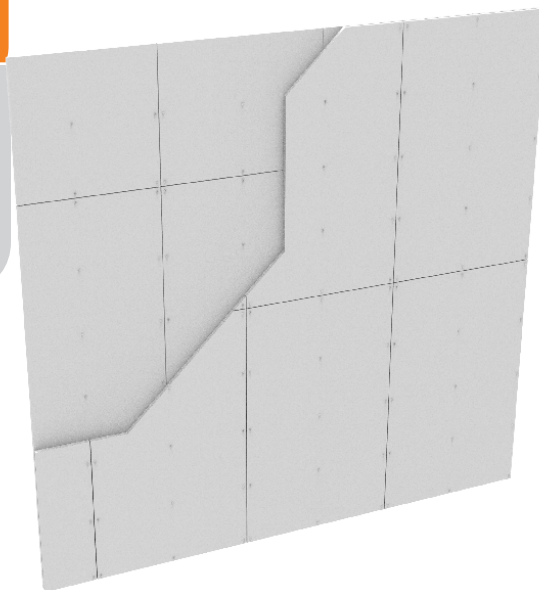

Trafalgar Corex has solid partition wall approvals when constructed with 2 layers of board for heights up to 4m. The proceeding table identifies the potential FRLs that can be achieved.

Board Thickness	Stud	Overall Wall Thickness	FRL (2-way FRL)	Max Span	Approved Bulkead-Fire Barrier Interfaces
2 x 15 mm	64 mm	94mm	-/60/60	Heights up to 4m	<ul style="list-style-type: none"> •Plasterboard walls •Plasterboard CH shaft walls •75mm AAC panel walls •Concrete/masonry walls
2 x 20 mm	64 mm	104mm	-/90/90		
2 x 25 mm	64 mm	114 mm	-/120/120		

FRL TABLES - 90 MINUTE WALLS

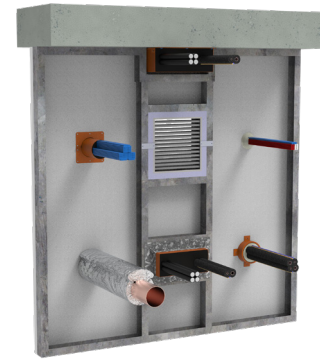

Trafalgar Corex Shaft Wall on one Side of Framework

Trafalgar Corex has solid partition wall approvals when constructed with 2 layers of board for heights up to 4m. The proceeding table identifies the potential FRLs that can be achieved when Trafalgar Corex is constructed as a shaft wall containing certain service penetrations.

Trade	Service Specification	Products	Max Annular gap	Fill Depth	TWrap Length	Fillet	FRL	Test Report
Electrical	30 x TPS cables 2.5mm ²	FyreFlex and TWrap	5mm	Full depth of COREX	300mm	50x50mm	-/90/90	FC01579
	8x 3C + E x 16mm ²							
Data and Comms	30 x CAT6 cables	FyreFlex and TWrap	5mm	Full depth of COREX	300mm	50x50mm	-/90/90	
	5 x Eltech VRF cables (ELT7501P)					30x30mm		
Fire Services	30 x TPS fire 1.5mm ²	FyreFlex and TWrap	5mm	Full depth of COREX	300mm	50x50mm	-/90/90	
	Sprinkler pipes up to 50mm		10mm		300mm	15x15mm		
	Sprinkler pipes up to 100mm				600mm			
Plumbing	Stainless steel pipes up to 100mm OD Min. 1.5mm wall thickness*	FyreFlex and TWrap	10mm	Full depth of COREX	600mm	30x30mm	-/90/90	
	Steel pipes up to NB50				15x15mm			
	Steel pipes up to NB100							
	Copper pipes up to DN50							
	Copper pipes up to DN100							
HVAC&R	PEX and PEX-AL-PEX pipes	SuperStopper Circular	20mm	Full depth of COREX	450mm	N/A	-/90/90	FC10266
	CHW and other lagged pipes	FyreCOLLAR Premium Hinged Retrofit with FyreFlex	111mm hole size	10mm	300mm	Backfill collar with FyreFlex	-/90/90	** FRT 220112
Multiple/Mixed services	Mixed pipes and cables with no separation requirements	FyreBox Range	See page 9 for details				FC10266	

* A layer of 100mm width x 60mm thick Maxilite Pad or 3 layers of 100mm width x 25mm thick Corex boards Pad around penetration on one side of the barrier

** contact technical@tgroup.com.au if you require access to the report.

FRL TABLES - 2 HOUR WALLS

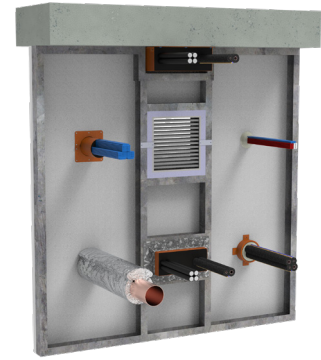

Trafalgar Corex Shaft Wall on one Side of Framework

Trafalgar Corex has solid partition wall approvals when constructed with 2 layers of board for heights up to 4m. The proceeding table identifies the potential FRLs that can be achieved when Trafalgar Corex is constructed as a shaft wall containing certain service penetrations.

Trade	Service Specification	Products	Max Annular gap	Fill Depth	TWrap Length	Fillet	FRL	Test Report
Electrical	30 x TPS cables 2.5mm ²	FyreFlex and TWrap	5mm	Full depth of COREX	300mm	50x50mm	-/120/120	FCO1579
	8x 3C + E x 16mm ²				2 layers of 300mm			
Data and Comms	30 x CAT6 cables	FyreFlex and TWrap	5mm	Full depth of COREX	300mm	50x50mm	-/120/120	
	5 x Eltech VRF cables (ELT7501P)					30x30mm		
Fire Services	30 x TPS fire 1.5mm ²	FyreFlex and TWrap	5mm	Full depth of COREX	300mm	50x50mm	-/120/120	
	Sprinkler pipes up to 50mm		10mm		600mm	15x15mm		
	Steel sprinkler pipes up to 100mm				600mm + 2nd layer of 300mm			
	Copper sprinkler pipes up to 100mm							
Plumbing	Stainless steel pipes up to 100mm OD Min. 1.5mm wall thickness*	FyreFlex and TWrap	10mm	Full depth of COREX	600mm	30x30mm	-/120/120	
	Steel pipes up to NB50					15x15mm		
	Steel pipes up to NB100							
	Copper pipes up to DN50							
	Copper pipes up to DN100				600mm + 2nd layer of 300mm			
HVAC&R	PEX and PEX-AL-PEX pipes	SuperStopper	20mm	Full depth of COREX	450mm	N/A	-/120/120	FC10266
	CHW and other lagged pipes							
	Generic 800x800mm fire damper rated for 120 mins integrity**	30mm Maxilite board	N/A				-/120/-	FAR3600
Multiple/Mixed services	Mixed pipes and cables with no separation requirements	FyreBox Range	See page 9 for details					FC10266

* A layer of 100mm width x 60mm thick Maxilite Pad or 3 layers of 100mm width x 25mm thick Corex boards Pad around penetration on one side of the barrier

** Achieves -/120/-. Aperture is lined with 1-3 layers of 30mm Maxilite strips. Apply FyreFlex to all joints in the Maxilite. See drawing on page 15.

FRL TABLES - FYREBOX

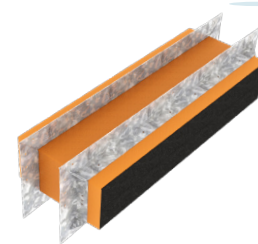

Trafalgar Corex Shaft Wall on one Side of Framework

2x laminated Corex boards fixed to one side of a 64mm steel stud. FRL of the wall is related to thickness of the Corex facings as shown in the table. FyreBox Maxi, Mini, Slab Mounts and SuperStopper Circulares all have the following approvals

Openings for FyreBox Maxis or Slab Mounts must be framed out with the same thickness COREX as the wall. See installation detail on page 22. Full instructions can be found in the respective FyreBox technical manuals.

Service Type	Service Specification		Corex Board Specification & FyreBOX Penetration FRL			TWrap Length required (mm)*
			2x15mm	2x20mm	2x25mm	
Plastic Pipes	PEX Pipes	Up to 32mm				450
		Up to 32mm with 19mm E-Flex insulation				450
	PEX-Al-PEX pipes	Up to 32mm				450
		Up to 32mm with 19mm E-Flex insulation				450
	cPVC Pipes	Up to 60mm				450
uPVC Pipes	up to 32mm	450				
Bare Metal Pipes	Copper	Up to 50mm				450
	Steel	up to 60mm				450
Metal Pipes Insulated**	Copper	Up to 50mm OD with PE insulation up to 20mm thick	-/60/60	-/90/90	-/120/120	450
		Up to 50mm OD with FR insulation				450
		Up to 20mm OD with 38mm rockwool-type insulation				450
	Pair coil	Up to 9.5 & 19mm with 13mm PE insulation				450
		Up to 9.5 & 19mm with 20mm FR insulation				450
Power Cables - Copper Core	TPS	Up to 12x 2.5mm ² per bundle				450
	AS1530.4 Appendix D1 cable set	Applies to copper core power cables and cable trays up to 1000mm wide				600**
Power Cables Aluminium Core	Single Core cables	Bundles of up to 3 x 240mm ² , 4 x 120mm ² and 9 x 70mm ² per bundle (16x cables total)				450
Communications Cables	RG6 coax	Up to 3x per bundle				450
	AS1530.4 Appendix D2 cable set	Applies to copper core comms cables, including cable trays up to 1000mm wide				450
Conduits	Rigid or Flexible PVC Conduits	Up to 32mm OD (with or without cables)				450

*For specific service based FRL's without using TWrap, refer to report FC10266. Without TWrap, the wall must be thickened on one side with 100mm wide Maxilite, 60mm thick around the penetration.

**Only 450mm of TWrap required for -/60/60 and -/90/90 applications

FIRE RATED ACCESS PANELS

Installation details are on page 16 and 17



It is common on construction sites to come across service shaft penetrations that only have one sided access. This can be an issue as most fire stopping systems are required to be symmetrical and as such need access to both sides for installation. Further to this, access to both sides is often required for inspection and maintenance throughout the life of the building.

A simple solution to this is to install an Access Panel. The main consideration is that much like service penetrating in the wall, the access panel must also be fire rated to maintain the FRL of the barrier.

The NCC requirements for an Access Panel in a service shaft, is -/xx/30. For example, an Access Panel installed into a 90min plasterboard shaft wall must achieve -/90/30. Trafalgar have a range of Access Panels designed to achieve this, none more prominent than the FyreSHIELD™.

FyreSHIELD™ is a proudly Australian made Access Panel system which has been designed and tested to be built into partition walls and riser shafts. With improved fire and acoustic performance while maintaining the signature Trafalgar Australian-made quality, the FyreSHIELD™ is the only Access Panel worth specifying and installing!

SOUND PROOF ACOUSTICS

Designed and built to achieve superior acoustic ratings in approved openings.

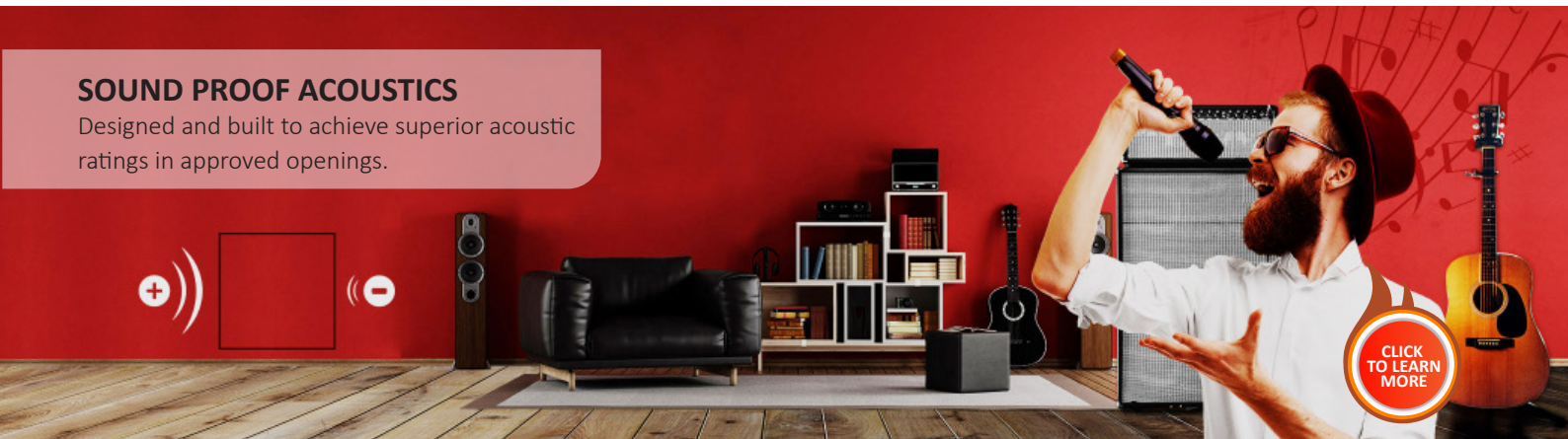

TILEABLE ACCESS PANEL

Designed to fit discretely into your kitchen, bathroom or other tiled surface.

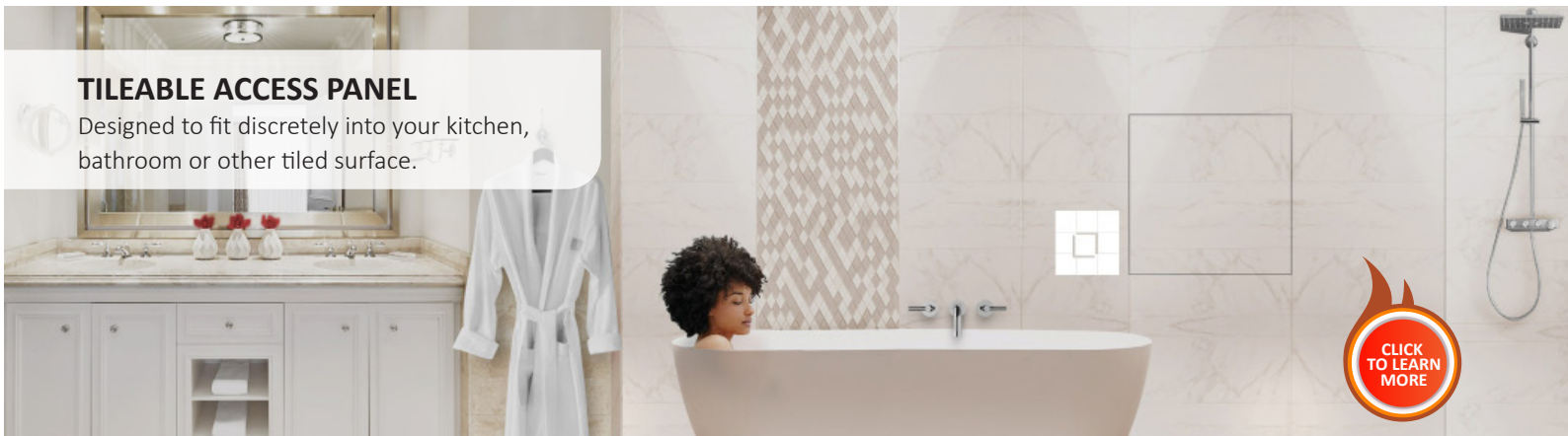

For more information on the FyreSHIELD™ range or any other Access Panels, go to taccess.com.au, or call 1800 888 714. In some instances, non-fire rated Access Panels will be required, for example a wall penetration within a non fire-rated ceiling space. In this instance, a non fire rated access panel could be installed in the ceiling to gain access to the service penetration for maintenance and inspection purposes. For our range of non fire-rated access panels head to taccess.com.au. The range includes metal, wood, acoustic, and more Access Panels for every application.

INSTALLATION

TRAFALGAR COREX WALL



FRAME

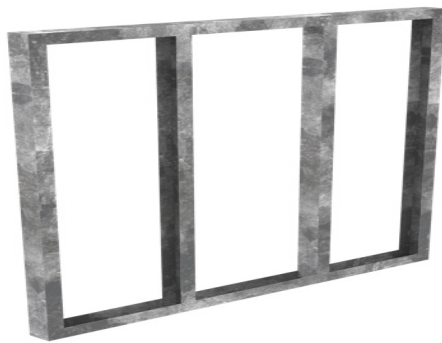

Frame the wall using 64mm steel studs at the perimeter and at 400mm centres. Use 6 x 45mm screws at 500mm centres. Fix framing to the surrounding walls and floors with appropriate fixings for the barrier.



PREPARE TRAFALGAR COREX

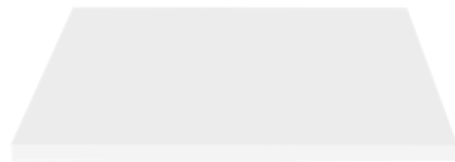

Score the Trafalgar Corex board to the required size with a Stanley knife and snap similarly to plasterboard

For assistance contact Trafalgar Fire's technical team at technical@tgroup.com.au



DEFLECTION HEAD

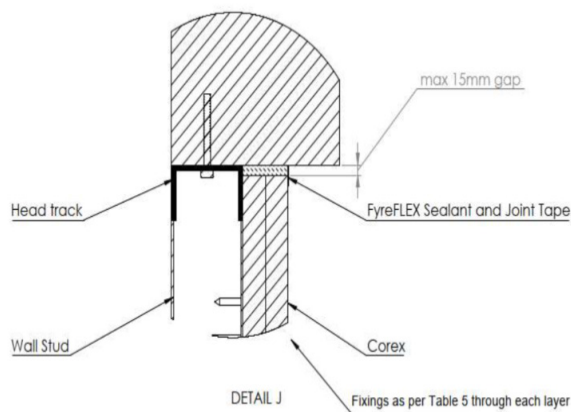

Allow max. 15mm gap where Corex meets the slab and infill with FyreFLEX sealant and apply joint tape.



FIRST TRAFALGAR COREX LAYER

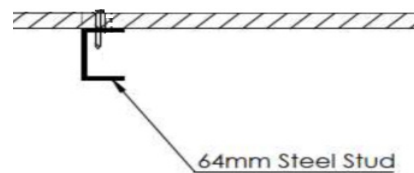

Apply the first layer of Trafalgar Corex board and fix using Min 8g x 45mm plasterboard screws at 400mm centres.

INSTALLATION

TRAFALGAR COREX WALL



SECOND TRAFALGAR COREX LAYER

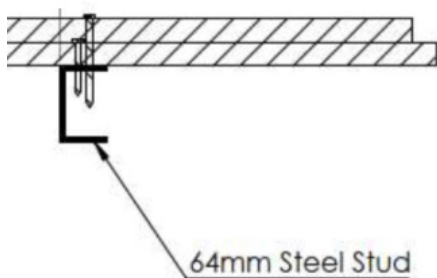

Apply the second layer of Trafalgar Corex board. Fix using Min 8g x 75mm plasterboard screws at 300mm centres.



CORNER JOINTS

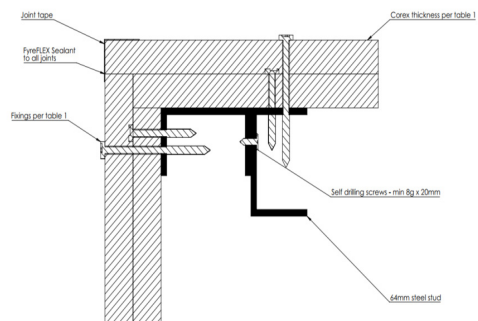

Apply FyreFLEX sealant to all joints and use joint tape to complete the corners and board joints. Install stud as depicted for corner joints.

For assistance contact Trafalgar Fire's technical team at technical@tgroup.com.au

PRODUCT RANGE



Item Number	Thickness	Board Size	Pallet QTY	Weight per Board
COREX-12.5	12.5mm	2000mm x 1200mm	40	27.6kg
COREX-15	15mm	2000mm x 1200mm	32	32.4kg
COREX-20	20mm	2000mm x 1200mm	24	42.24kg
COREX-25	25mm	2000mm x 1200mm	18	52.6kg

PRODUCT SYSTEM RANGE



Item Number	Description	Min Order Qty	Pallet QTY
FyreFLEX 300W FyreFLEX 300G	FyreFLEX® Sealant Cartridge 300ml White or Grey	20	1920
FyreFLEX 600W FyreFLEX 600G	FyreFLEX® Sealant Sausage 600ml White or Grey	18	1040
FyreFLEX 10W FyreFLEX 10G	FyreFLEX® Sealant Pail 10L White or Grey	1	64

FAQ

Q Can I use Trafalgar Corex board to construct a horizontal bulkhead?

A No, for horizontal bulkheads refer to the Maxilite horizontal bulkhead tech guide.

Q I have tight space requirements, can I use 1 layer of Trafalgar Corex board for vertical bulkheads?

A Trafalgar Corex has approvals for vertical bulkheads constructed with 2-layers of board only.

Q Do the fixings require FyreFLEX sealant where the Trafalgar Corex board is penetrated?

A FyreFLEX sealant is not required for the fixings.

Q Are there any two hour rated penetration systems?

A Testing is currently ongoing - contact Trafalgar for updated penetration system testing.

Q Can I install a damper into a Corex partition wall?

A Yes, it is possible with the use of 1-3 layers of minimum 30mm Maxilite. Please refer to drawing on the next page and also tech guide.

Q Can I paint over Trafalgar Corex board?

A Yes, it can be painted like any plasterboard wall.

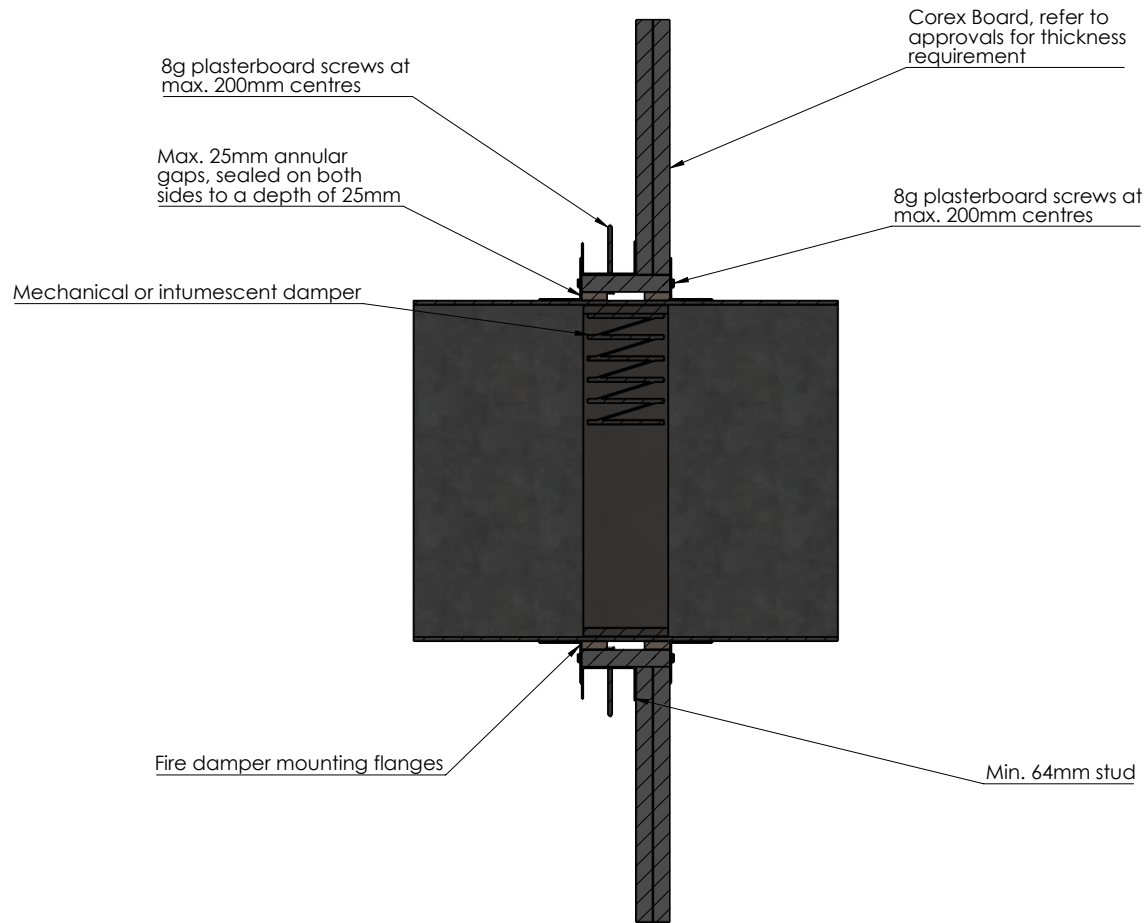

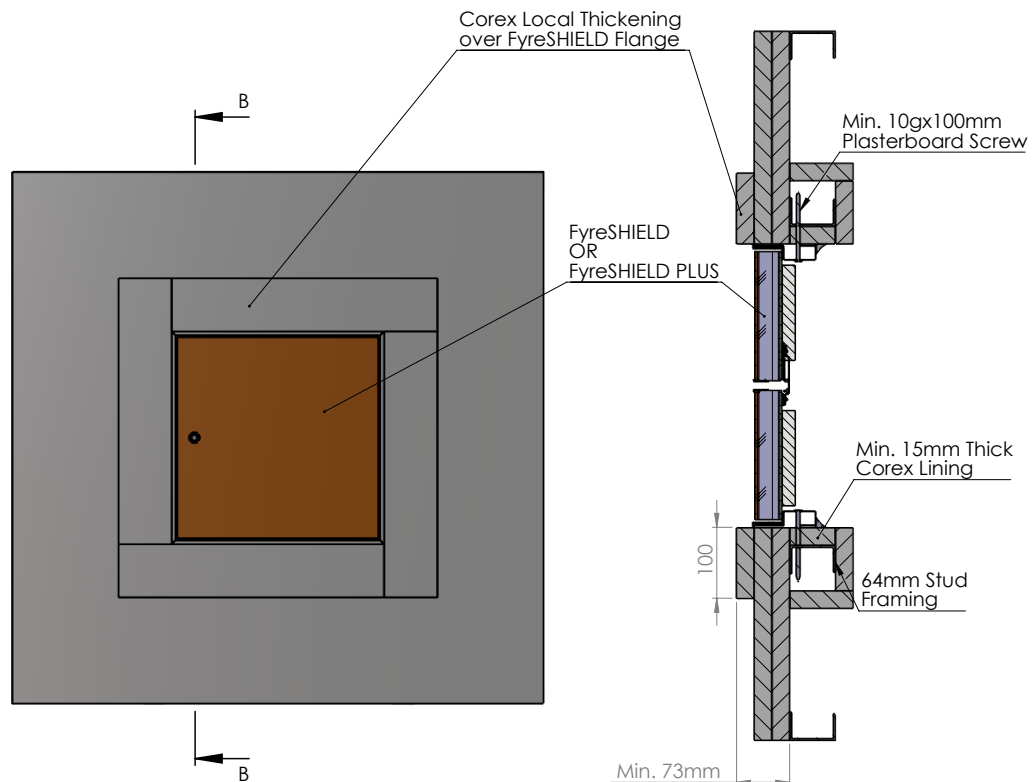

Drawing Name: WMD4				Test Standard: AS1530.4	Codes:	Revision:	Date:	No.:	NOTICE:
Project Title: Corex Wall Mounted Dampers				Fire resistance level:	Drawn By: MP	NOTE: ALL DIMENSIONS ARE IN MILLIMETRES (mm)			
Drawing No. : 1	Sheet: 1 of 1	Date: 9/12/2021	Scale: NTS	Based on Report No.:	Checked By: JH	<input type="checkbox"/> STANDARD DRAWING	 <p>TRAFALGAR FIRE</p> <p><small>Trafalgar Head Office: PO BOX 545 Chester Hill NSW 2162 T: 1800 888 714 F: 1800 201 500 E: technical@tgroup.com.au W: www.tfire.com.au</small></p>		
						<input type="checkbox"/> PROJECT DRAWING			

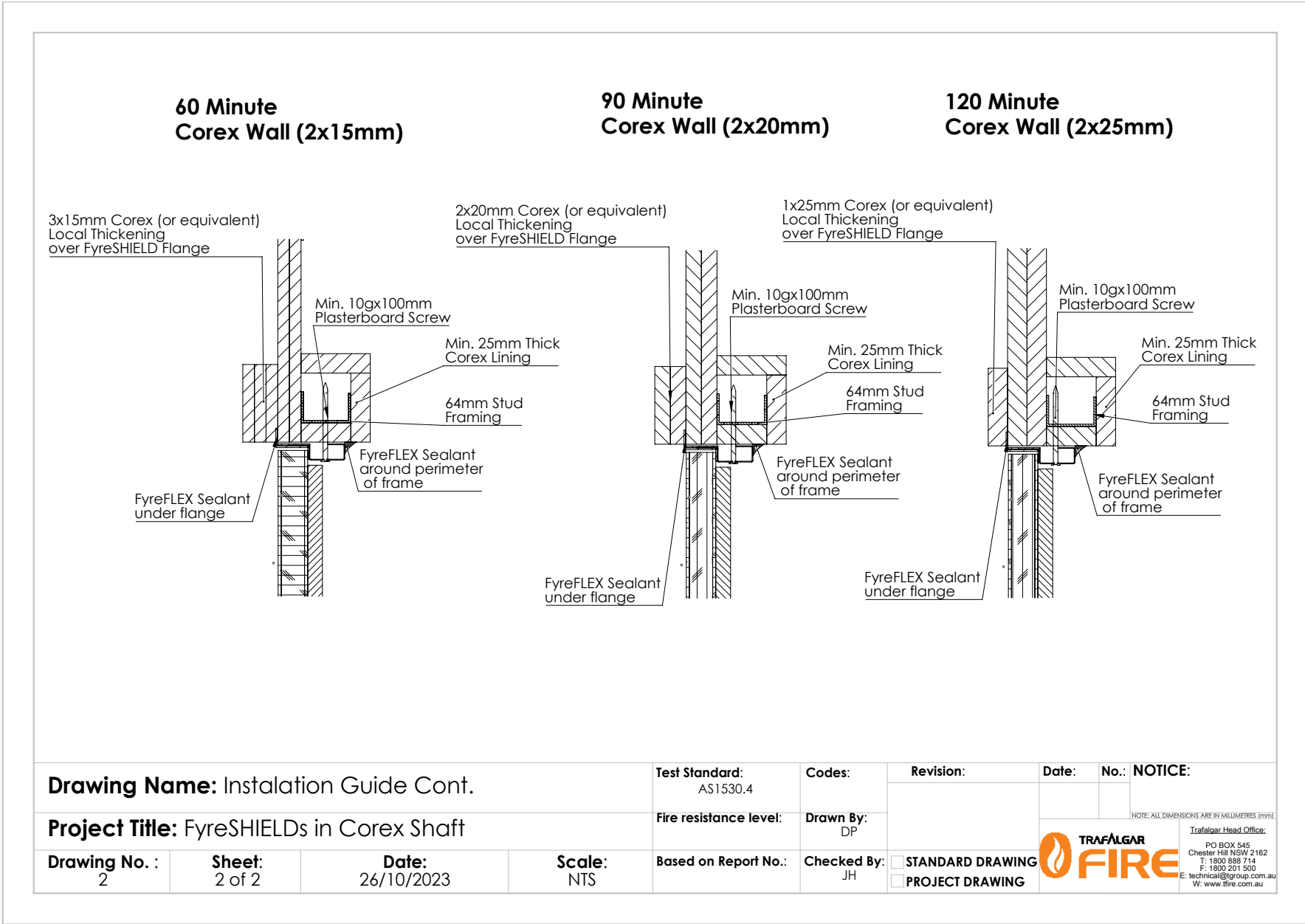

Corex Wall Configuration	Corex Local Thickening	FRL
2x15mm	Min. 43mm (eg. 3x15mm)	-/60/30 without Rakbak -/60/60 with Rakbak
2x20mm	Min. 33mm (eg. 2x20mm)	-/90/30 without Rakbak -/90/60 with Rakbak
2x25mm	Min. 25mm (eg. 1x25mm)	-/120/30 without Rakbak -/120/60 with Rakbak

Drawing Name: FyreSHIELD				Test Standard: AS1530.4	Codes:	Revision:	Date:	No.:	NOTICE:
Project Title: FyreSHIELDS in Corex Shaft				Fire resistance level:	Drawn By: DP	<small>NOTE: ALL DIMENSIONS ARE IN MILLIMETRES (mm)</small>			
Drawing No. : 1	Sheet: 1 of 2	Date: 26/10/2023	Scale: NTS	Based on Report No.:	Checked By: JH	<input type="checkbox"/> STANDARD DRAWING	<input type="checkbox"/> PROJECT DRAWING	 <p><small>Trafalgar Head Office: PO BOX 545 Chester Hill NSW 2162 T: 1800 888 714 F: 1800 201 500 E: technical@group.com.au W: www.fire.com.au</small></p>	



Drawing Name: Instalation Guide Cont.				Test Standard: AS1530.4	Codes:	Revision:	Date:	No.:	NOTICE:
Project Title: FyreSHIELDS in Corex Shaft				Fire resistance level:	Drawn By: DP	<small>NOTE: ALL DIMENSIONS ARE IN MILLIMETRES (mm)</small>			
Drawing No. : 2	Sheet: 2 of 2	Date: 26/10/2023	Scale: NTS	Based on Report No.:	Checked By: JH	<input type="checkbox"/> STANDARD DRAWING	 <p>TRAFALGAR FIRE</p> <p><small>TRafalgar Head Office: PO BOX 545 Chester Hill NSW 2162 T: 1800 888 714 F: 1800 201 500 E: technical@tgroup.com.au W: www.tfire.com.au</small></p>		
<input type="checkbox"/> PROJECT DRAWING									

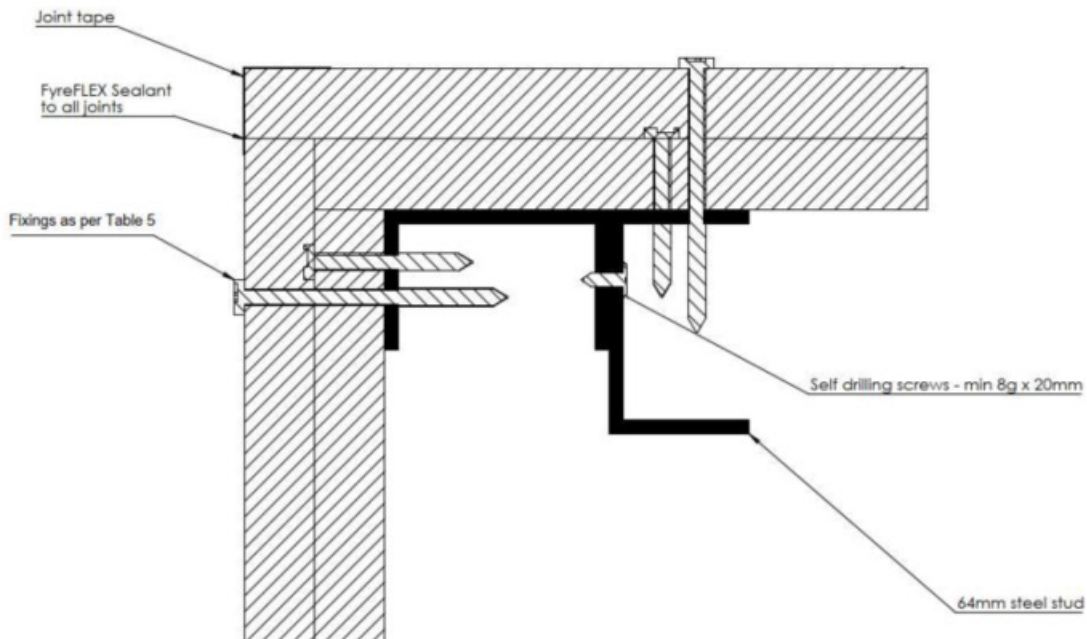
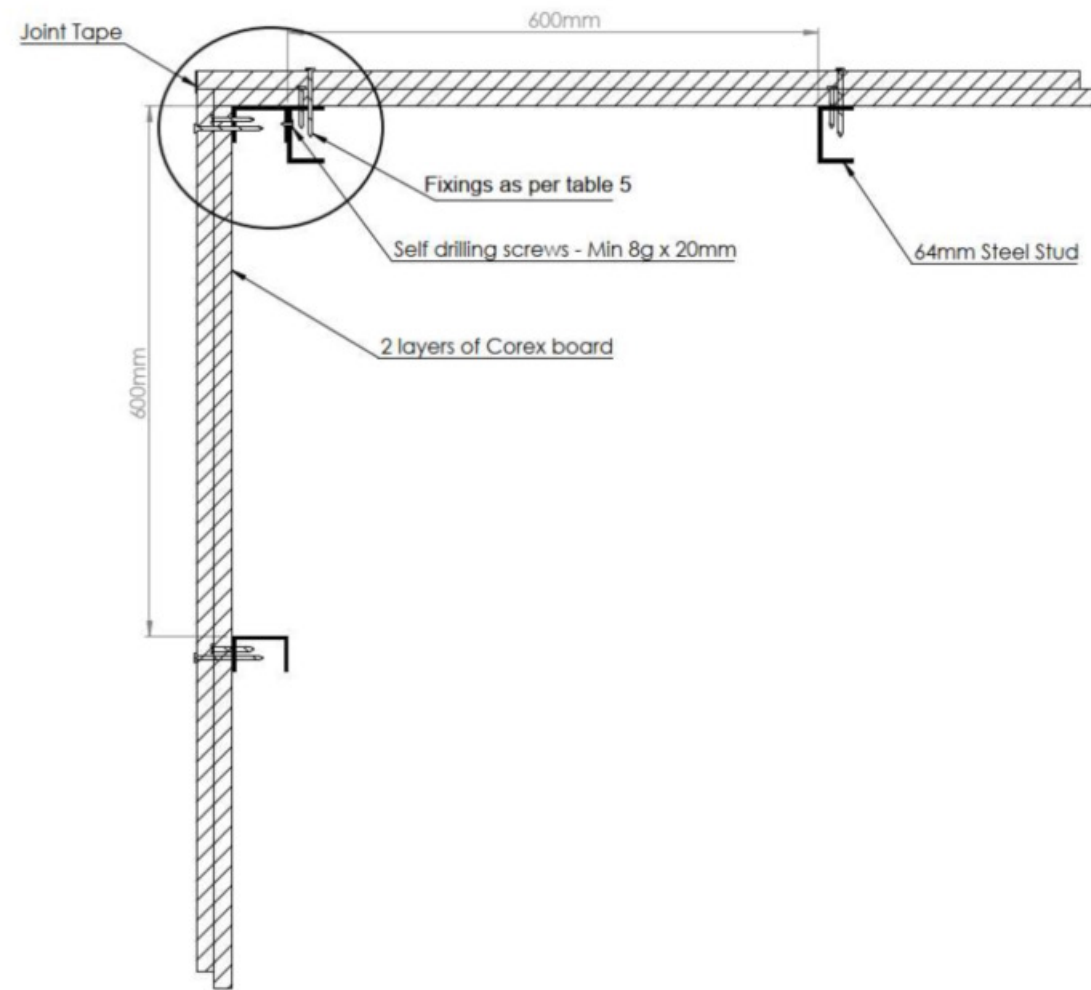

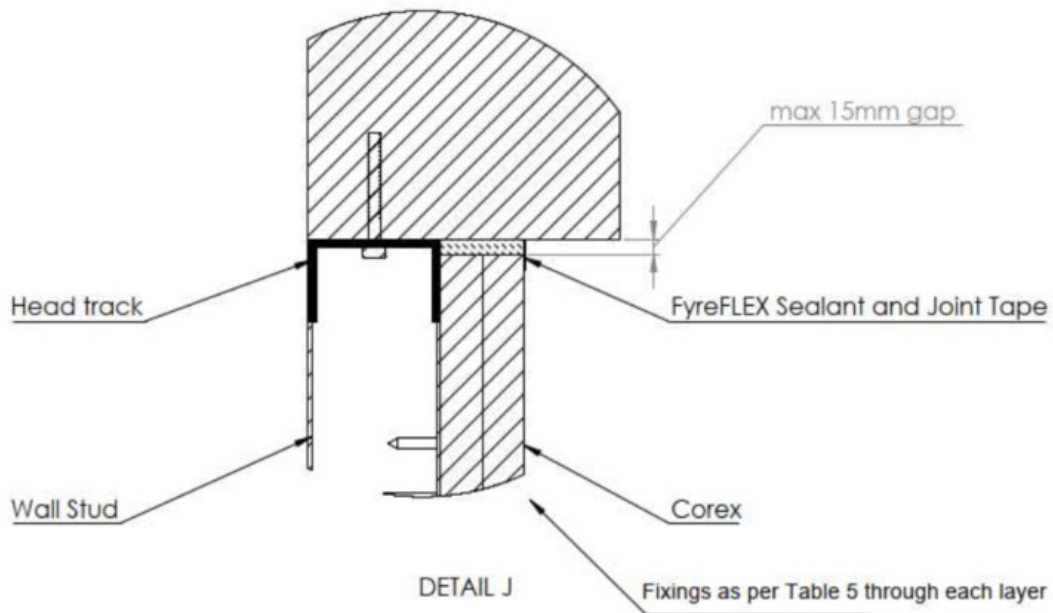
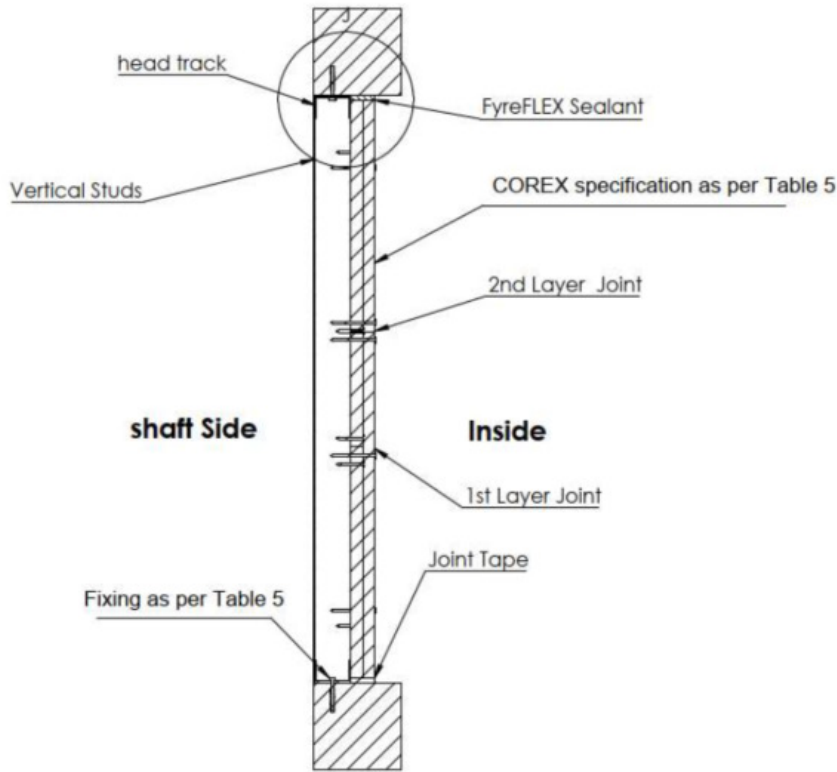

Stud fixing and head of wall detail

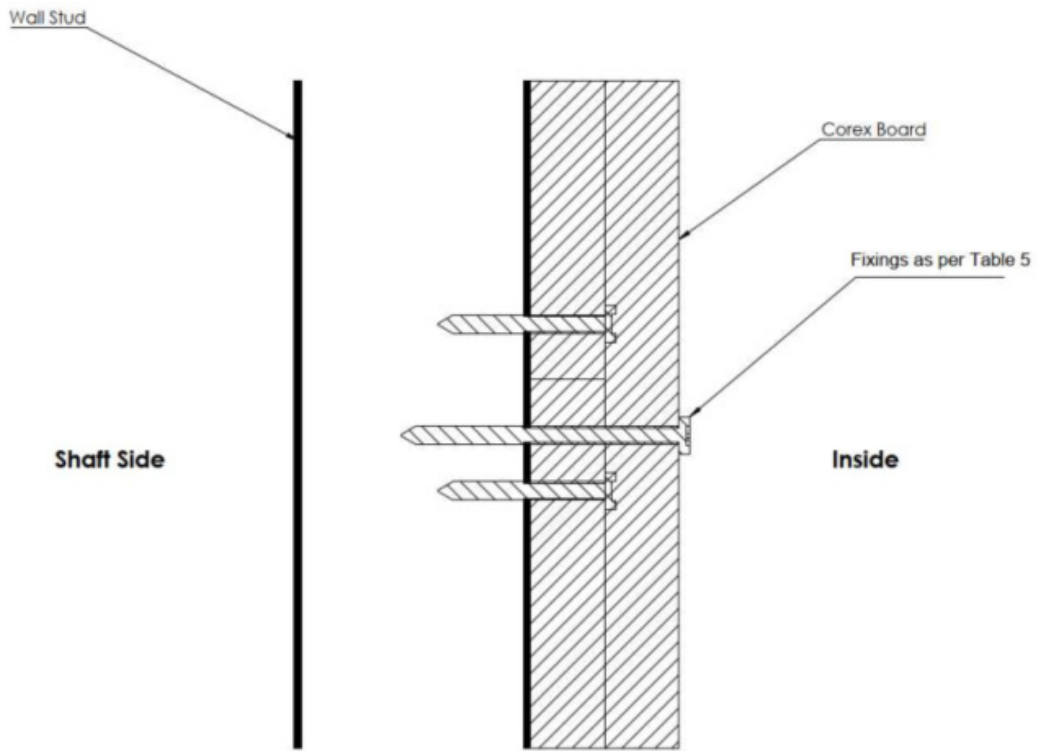

First layer joint

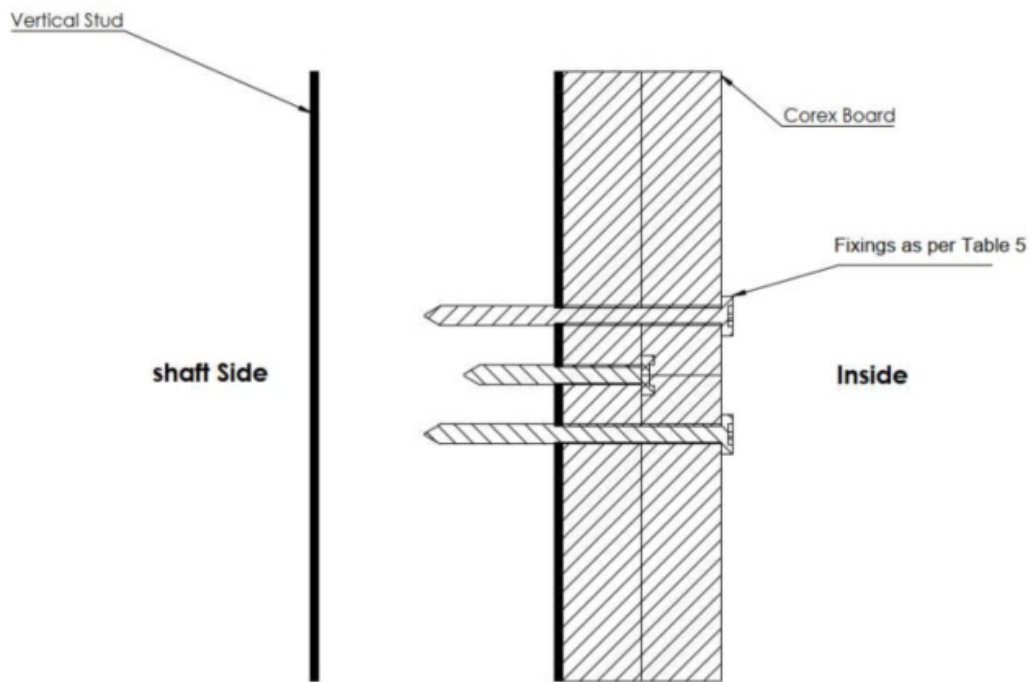

Second layer joint

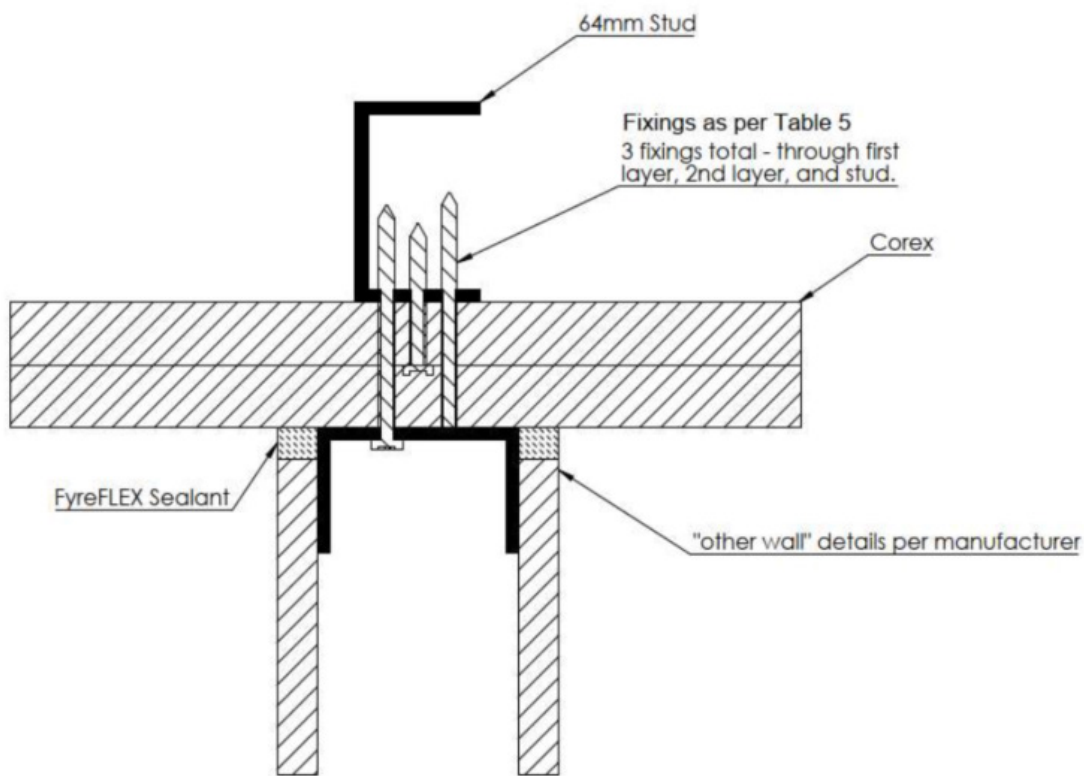

T junction with other walls

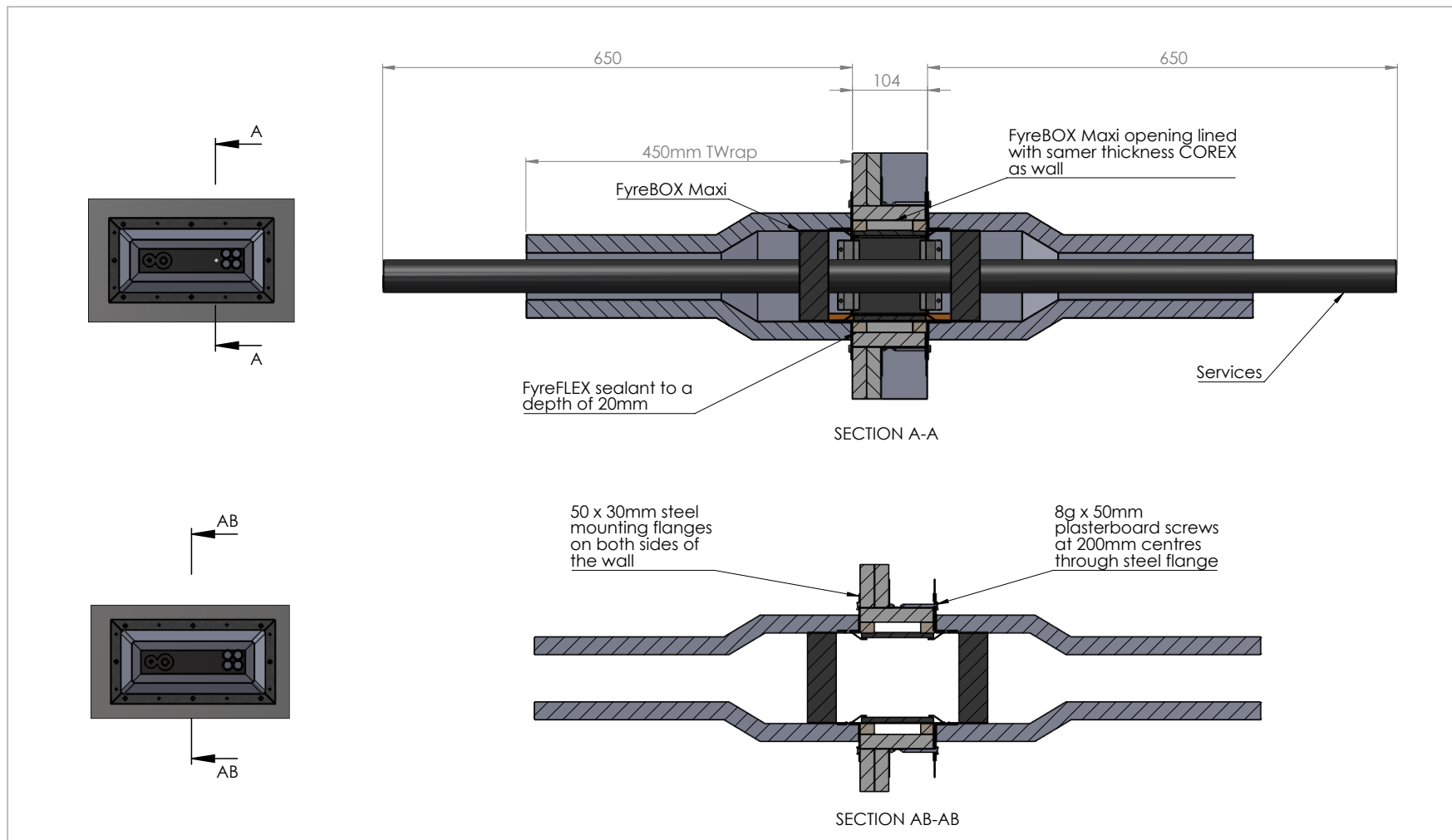

Drawing Name: FyreBox Installation Detail				Test Standard: AS1530.4	Codes:	Revision:	Date:	No.:	NOTICE:
Project Title: COREX wall technical manual				Fire resistance level:	Drawn By: MP	<small>NOTE: ALL DIMENSIONS ARE IN MILLIMETRES (mm).</small>			
Drawing No. : 4	Sheet: 4 of 10	Date: 23/10/2023	Scale: NTS	Based on Report No.:	Checked By: JH	<input type="checkbox"/> STANDARD DRAWING	 <p><small>Trafalgar Head Office: PO BOX 545 Chester Hill NSW 2162 T: 1800 888 714 F: 1800 201 500 E: technical@tgroup.com.au W: www.tfire.com.au</small></p>		
						<input type="checkbox"/> PROJECT DRAWING			